

Madison Heights
Plumbing & Heating Supply

CATALOG



SECTIONS

1.) Toilets	3-20
2.) Sinks	21-46
3.) Tub & Shower	47-62
4.) Valves	63-74
5.) Pipe & Fittings	75-148
6.) Sump Pumps & Buckets	149-152
7.) Water Heaters	153-168
8.) Plumbing Supplies	169-182
9.) Brackets & Hangers	183-191
10.) Hardware & Tools	192-207
11.) Drains & Cleanouts	208-212
12.) Cleaning & Cements	213-219

Madison Heights Plumbing & Heating Supply

SECTION 1 - TOILETS

Toilets	4-10
Urinals	10
Toilet Seats	11
Toilet Repair Parts	12-17
Sloan Parts	18-20

Maxwell



- Two piece toilet combination
- Available in standard round, elongated, & ADA elongated bowls
- 2" large fully glazed p-trap
- 3" flush valve for faster water flow
- 1.28 GPF water efficiency
- Color matching metal tank lever
- Toilet seat not included
- Includes color matching toilet bolt caps
- Installation materials not included (wax ring, closet bolts, etc.)

Gerber Maxwell Complete Toilets

Part No#	Gerber Part#	Description	Color
GER21-902	21-902	15" Maxwell Round Bowl & Tank Complete	White
GER21-912	21-912	15" Maxwell Elongated Bowl & Tank Complete	White
GER21-918	21-918	17" Maxwell Elongated Bowl & Tank Complete	White

Gerber Maxwell Parts Breakdown

Part No#	Gerber Part#	Description	Color
GER21-952	21-952	15" Maxwell Round Bowl Only	White
GER21-962	21-962	15" Maxwell Elongated Bowl Only	White
GER21-928	21-928	17" Maxwell Elongated Bowl Only	White
GER28-990	28-990	12" Maxwell Left Hand Tank Only	White
GER28-990-97	28-990-97	12" Maxwell Right Hand Tank Only	White
GER28-995	28-995	10" Maxwell Left Hand Tank Only	White
GER28-994	28-994	14" Maxwell Left Hand Tank Only	White

Viper



- Two piece toilet combination
- Available in standard round, elongated, & ADA elongated bowls
- 2" large fully glazed p-trap
- 3" flush valve for faster water flow
- 1.6 GPF
- Color matching metal tank lever
- Toilet seat not included
- Includes color matching toilet bolt caps
- Installation materials not included (wax ring, closet bolts, etc.)

Gerber Viper Complete Toilets

Part No#	Gerber Part#	Description	Color
GER21-502	21-502	15" Viper Round Bowl & Tank Complete	White
GER21-512	21-512	15" Viper Elongated Bowl & Tank Complete	White
GER21-518	21-518	17" Viper Elongated Bowl & Tank Complete	White

Gerber Viper Parts Breakdown

Part No#	Gerber Part#	Description	Color
GER21-552	21-552	15" Viper Round Bowl Only	White
GER21-562	21-562	15" Viper Elongated Bowl Only	White
GER21-528	21-528	17" Viper Elongated Bowl Only	White
GER28-590	28-590	12" Viper Left Hand Tank Only	White
GER28-590-97	28-590-97	12" Viper Right Hand Tank Only	White
GER28-595	28-595	10" Viper Left Hand Tank Only	White
GER28-594	28-594	14" Viper Left Hand Tank Only	White

Compact Viper



- Two piece toilet combination
- Unique design allows elongated bowl to fit in the space of a round bowl
- 2" large fully glazed p-trap
- 3" flush valve for faster water flow
- 1.28 GPF water efficiency
- Color matching metal tank lever
- Toilet seat not included
- Includes color matching toilet bolt caps
- Installation materials not included (wax ring, closet bolts, etc.)

Gerber Compact Viper Parts Breakdown

Part No#	Gerber Part#	Description	Color
GERHE21-872	HE-21-872	17" Compact Viper Elongated Bowl Only	White
GERHE28-570	HE-28-570	12" Compact Viper Left Hand Tank Only	White

Avalanche



- Two piece toilet combination
- Available in standard round, elongated, & ADA elongated bowls
- 2" large fully glazed p-trap
- 3" flush valve for faster water flow
- 1.6 GPF
- Color matching metal tank lever
- Toilet seat not included
- Includes color matching toilet bolt caps
- Installation materials not included (wax ring, closet bolts, etc.)

Gerber Avalanche Complete Toilets

Part No#	Gerber Part#	Description	Color
GER21-802	21-802	15" Avalanche Round Bowl & Tank Complete	White
GER21-812	21-812	15" Avalanche Elongated Bowl & Tank Complete	White
GER21-818	21-818	17" Avalanche Elongated Bowl & Tank Complete	White

Gerber Viper Parts Breakdown

Part No#	Gerber Part#	Description	Color
GER21-852	21-852	15" Avalanche Round Bowl Only	White
GER21-862	21-862	15" Avalanche Elongated Bowl Only	White
GER21-828	21-828	17" Avalanche Elongated Bowl Only	White
GER28-890	28-890	12" Avalanche Left Hand Tank Only	White

Avalanche Elite



- Two piece toilet combination
- Available in ADA Round
- 2" large fully glazed p-trap
- 3" flush valve for faster water flow
- 1.6 GPF
- Chrome metal tank lever
- Toilet seat not included
- Includes color matching toilet bolt caps
- Installation materials not included (wax ring, closet bolts, etc.)

Gerber Avalanche Elite Parts Breakdown

Part No#	Gerber Part#	Description	Color
GERAB21-852	AB-21-852	17" Avalanche Elite Round Bowl Only	White
GERAL28-890	AL-28-890	12" Avalanche Elite Left Hand Tank Only	White

Ultra Flush



- Two piece toilet combination
- Available in standard round, elongated, & ADA elongated bowls
- 2" large fully glazed p-trap
- Flushmate cylinder inside for pressure flush
- 1.6 GPF
- Chrome metal tank lever
- Toilet seat not included
- Includes color matching toilet bolt caps
- Installation materials not included (wax ring, closet bolts, etc.)

Gerber Ultra Flush Complete Toilets

Part No#	Gerber Part#	Description	Color
GER21-302	21-302	15" Ultra Flush Round Bowl & Tank Complete	White
GER21-312	21-312	15" Ultra Flush Elongated Bowl & Tank Complete	White
GER21-318	21-318	17" Ultra Flush Elongated Bowl & Tank Complete	White

Gerber Ultra Flush Parts Breakdown

Part No#	Gerber Part#	Description	Color
GER21-342	21-342	15" Ultra Flush Round Bowl Only	White
GER21-372	21-372	15" Ultra Flush Elongated Bowl Only	White
GER21-377	21-377	17" Ultra Flush Elongated Bowl Only	White
GER28-380	28-380	12" Ultra Flush Left Hand Tank Only	White
GER28-380-97	28-380-97	12" Ultra Flush Right Hand Tank Only	White
GER28-385	28-385	10" Ultra Flush Left Hand Tank Only	White
GER28-384	28-384	14" Ultra Flush Left Hand Tank Only	White

TOILETS/URINALS

Gerber ADA Elongated Top Spud Bowl



- . Uses exposed flush valve
- . ADA compliant
- . 1-1/2" brass closet spud included

Part No#	Gerber Part#	Color
GER25-733	25-733	White

Gerber Elongated Top Spud Bowl



- . Uses exposed flush valve
- . Standard elongated bowl
- . 1-1/2" brass closet spud included

Part No#	Gerber Part#	Color
GER25-833	25-833	White

American Standard Wall Hung Toilet



- . Uses exposed flush valve
- . ADA compliant
- . 1-1/2" brass closet spud included

Part No#	American Standard Part#	Color
AME2257.001	2257.001	White

Gerber Elongated Back Outlet Bowl Only



- . Uses Gerber# 28-380 tank
- . Floor mounted wall outlet bowl only

Part No#	Gerber Part#	Color
GER21-374	21-374	White

Gerber Monitor ADA Top Spud Urinal



- . Elongated rim
- . ADA compliant
- . Enclosed trap
- . 3/4" urinal spud outlet

Part No#	Gerber Part#	Color
GERHE27-800	HE27-800	White

Gerber Clinton ADA Top Spud Urinal



- . Enclosed trap
- . ADA compliant
- . 3/4" urinal spud outlet

Part No#	Gerber Part#	Color
GER27-750	27-750	White

Gerber Lafayette Top Spud Urinal



- . Exposed trap
- . 3/4" urinal spud outlet
- . 1-1/2" spud bottom outlet

Part No#	Gerber Part#	Color
GER27-740	27-740	White

TOILET SEATS

Round Plastic Closed Front Seat



- . Plastic Round Seat With Cover
- . For Residential Use

Part No#	Color	Type
BEM70WHITE	White	Plastic

Elongated Plastic Closed Front Seat



- . Plastic Elongated Seat With Cover
- . For Residential Use

Part No#	Color	Type
BEM170WHITE	White	Plastic

Round Wood Closed Front Seat



- . Molded Wood Round With Cover
- . Easy Clean & Change Design
- . For Residential Use

Part No#	Color	Type
BEM500WHITE	White	Wood
BEM500BONE	Bone	Wood
BEM500BISC	Biscuit	Wood

Elongated Wood Closed Front Seat



- . Molded Wood Elongated With Cover
- . Easy Clean & Change Design
- . For Residential Use

Part No#	Color	Type
BEM1500WHITE	White	Wood
BEM1500BONE	Bone	Wood
BEM1500BISC	Biscuit	Wood

**LOOKING FOR A SPECIFIC TOILET SEAT COLOR
NOT LISTED IN THIS CATALOG? GIVE US A CALL
WE MAY STILL HAVE IT!**

Round Plastic Open Front Seat



- . Plastic Round Seat Less Cover
- . For Commercial Use

Part No#	Color	Type
BEM955CWHITE	White	Plastic

Elongated Plastic Open Front Seat



- . Plastic Elongated Seat Less Cover
- . For Commercial Use

Part No#	Color	Type
BEM1955CWHITE	White	Plastic
BEM1955CBLK	Black	Plastic

Round Plastic Soft Closing Closed Front Seat



- . Plastic Round Seat With Cover
- . Soft Closing Hinge Design
- . For Residential Use

Part No#	Color	Type
BEM200SLOWHITE	White	Plastic

Elongated Plastic Soft Closing Closed Front Seat



- . Plastic Elongated Seat With Cover
- . Soft Closing Hinge Design
- . For Residential Use

Part No#	Color	Type
BEM1200SLOWHITE	White	Plastic
BEM1200SLOBONE	Bone	Plastic
BEM1200SLOBISC	Biscuit	Plastic

Elongated Plastic 2" Lift Open Front Seat



- . Plastic Elongated Seat Less Cover
- . 2" Lift To Meet ADA Requirements
- . For Commercial Use

Part No#	Color	Type
BEM2L2155WHITE	White	Plastic

Sloan Flushmate Cartridge



. Replacement cartridge for Sloan Flushmate tank cylinders

Part No#	Sloan Part#	Type
SLOC100500K	C100500K	Plastic

Sloan Flushmate Cartridge Wrench



. Universal to fit all flushmate cartridges
 . Can also be used to tighten or remove supply nut on tank
 . Can also be used to tighten or remove large cylinder nut

Part No#	Sloan Part#	Type
SLOST100100	ST100100	Tool

Flapper For Gerber Closets



. Fits any Gerber toilet with a 3" flush valve
 . Includes stainless steel chain

Part No#	Geber Part#	Size
GER99-770	99-770	3"

Tank To Bowl Gasket For Gerber Ultra Flush Closet



. Replacement rubber gasket for Gerber 28-380 tank

Part No#	Geber Part#	Color
GER99-591	99-591	Green

Tank To Bowl Kit For Gerber Closet



. Tank to bowl kit for any Gerber toilet with a 3" flush valve

Part No#	Geber Part#	Size
GER99-660	99-660	3"

Gerber Urinal Flange



. Brass urinal flange fits all Gerber urinals except 27-740
 . 2" outlet

Part No#	Gerber Part#	Type
GER99-160	99-160	Brass

Gerber Urinal Bracket



. Urinal bracket fits all Gerber urinals except 27-740

Part No#	Gerber Part#	Type
GER99-290	99-290	Metal

Bracket For Gerber Wall Hung Sink & Urinal



. Replacement bracket for Gerber wall hung china sinks
 . Bracket will also work for Gerber urinal 27-740

Part No#	Gerber Part#	Type
GER99-161	99-161	Metal

Replacement Handle For Gerber Toilets



. Replacement handles for Gerber toilets

Part No#	Gerber Part#	Toilet
GER99-841	99-841	Maxwell
GER99-001-WH	99-001-WH	Viper
GER99-685-WH	99-685-WH	Avalanche

Handle For Gerber Ultra Flush Closet



. Part# 99-571 fits Gerber tank# 28-380
 . Part# 99-571RH fits Gerber tank# 28-380-97

Part No#	Gerber Part#	Type
GER99-571KT	99-571	Left Hand
GER99-571RHKT	99-571RH	Right Hand

Standard Wax Ring



- . Basic wax ring
- . Installs easily
- . Fits any 3" or 4" outlet on floor mount toilets

Part No#	Description	Type
FLUPRO700	Standard Wax Ring	Wax Ring

Standard Wax Ring With Horn

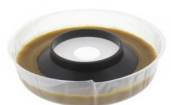

- . Reinforced wax ring flange for better seal
- . Installs easily
- . Fits any 3" or 4" outlet on floor mount toilets

Part No#	Description	Type
FLUPRO70F	Wax Ring With Horn	Wax Ring

Extra Thick Wax Ring With Horn



- . Extra thick design for low closet flanges
- . Installs easily
- . Fits any 3" or 4" outlet on floor mount toilets

Part No#	Description	Type
FLUPRO80F	Thick Wax Ring With Horn	Wax Ring

Neo Seal Wax Ring For Wall Hung Toilets



- . Neo seal gasket for any style wall hung toilet
- . Long lasting and durable connection

Part No#	Zurn Part#	Type
ZURNEOSEAL	Z5977-NEO	Rubber

Carrier Kit For Wall Mount Closets



- . Hardware kit for wall mount toilets
- . Includes gasket, nuts, washers, & sealant

Part No#	Description	Type
SMIFIN	Wall Mount Carrier Kit	Metal

Closet Bolt Caps



- . Round plastic closet bolt caps
- . Includes two caps per bag

Part No#	Description	Type
PASWHTBOLTCAP	White Closet Bolt Cap	Plastic

Brass Closet Bolts



- . Brass bolts for mounting floor mount toilets
- . Includes two bolts, nuts, plastic and metal washers

Part No#	Size	Type
HARBRASSJOHNNY	5-16" x 2-1/4"	Brass
WALBRASSLONGBOLT	5-1/6" x 3-1/2"	Brass

Plastic Closet Bolts



- . Plastic bolts for mounting floor mount toilets
- . Plastic easy to cut design
- . Includes two bolts and nuts

Part No#	Size	Type
SIOPVCCLOSETBOLT	5/16" x 2-1/2"	Plastic
SIOLONGPVCCLOSETBOLT	5/16" x 3-1/2"	Plastic

Two Bolt Tank To Bowl Kit



- . Universal bolt kit to fit any toilet that requires two bolts
- . Includes two bolts, nuts, rubber and metal washers

Part No#	Size	Type
PASTANKTOBOWLBOLT	5/16" x 2-1/4"	Brass

Tank To Bowl Kit For Gerber Closet



- . Tank to bowl kit for any Gerber toilet with a 3" flush valve

Part No#	Geber Part#	Size
GER99-660	99-660	3"

Three Bolt Tank To Bowl Kit



- . Universal bolt kit to fit any toilet that requires three bolts
- . Includes three bolts, nuts, rubber and metal washers

Part No#	Size	Type
FLUTANKTOBOWL3	5/16" x 2-3/4"	Brass

Universal Brass Tank Handle



- . Fits most front mount toilets
- . Chrome plated metal handle
- . 8" brass arm with nut and spud

Part No#	Style	Type
PASCPTANKHANDLE	Universal	Metal

Universal Large Brass Tank Handle



- . Fits most front, side and angle mount toilets
- . Large chrome plated handle

Part No#	Fluidmaster Part#	Type
FLUPRO64	PRO64	Metal

Plastic Tank Handle For Mansfield Closets



- . Fits most front mount toilets for Mansfield
- . 9" plastic arm with nut and spud

Part No#	Style	Type
PASMANSFIELD41	Mansfield	Plastic

Handle For Gerber Ultra Flush Closet



- . Part# 99-571 fits Gerber tank# 28-380
- . Part# 99-571RH fits Gerber tank# 28-380-97

Part No#	Gerber Part#	Type
GER99-571KT	99-571	Left Hand
GER99-571RHKT	99-571RH	Right Hand

Replacement Handle For Gerber Toilets



- . Replacement handles for Gerber toilets

Part No#	Gerber Part#	Toilet
GER99-841	99-841	Maxwell
GER99-001-WH	99-001-WH	Viper
GER99-685-WH	99-685-WH	Avalanche

Universal Fill Valve



- . Universal fit for most brands
- . Easy to install

Part No#	Fluidmaster Part#	Item
FLUPRO45	PRO45	Fill Valve

Universal Toilet Rebuild Kit



- . Universal fit for most brands
- . Easy to install
- . Includes flush valve and fill valve with hardware

Part No#	Fluidmaster Part#	Item
FLUPRO45K	PRO45K	Toilet Rebuild Kit

Fill Valve For Toto



- . Fits all Toto brand toilets
- . Includes fill valve and hardware

Part No#	Style	Type
LAV528GT	Toto	Plastic

Universal 3" Flush Valve Kit



- . Universal fit for most toilets with a 3" flush
- . Easy to install
- . Repairs leaks between tank and bowl

Part No#	Description	Type
FLU540AKRP5	3" PVC Flush Valve Kit	Plastic

Universal PVC Flush Valve



- . Universal to replace most 2" flush valves
- . Includes flapper and chain

Part No#	Style	Type
PASPVCFLUSHVALVE	Universal	Plastic

PVC Flush Valve For Mansfield



- . Fits Mansfield #210 style flush valves
- . Will not rust or corrode

Part No#	Style	Type
WAL210FLUSHVALVE	Mansfield	Plastic

Replacement Red Gasket for Mansfield



- . Fits Mansfield #210 and #211 flush valves
- . Chlorine resistant rubber

Part No#	Korky Part#	Type
LAV427BP	427BP	Rubber

Replacement Black Seal For Mansfield



- . Fits Mansfield #208 and #209 flush valves
- . Flexible black rubber

Part No#	Korky Part#	Type
LAV426BP	426BP	Rubber

Replacement Red Gasket For Tower Flush Valves



- . Includes two tower style gaskets
- . Repairs both American Standard & Kohler toilets

Part No#	Korky Part#	Type
LAV435BP	435BP	Rubber

Replacement Gasket For American Standard



- . Fits American Standard Champion and Eljer Titan
- . Fits 4" flush valve opening
- . Chlorine resistant rubber

Part No#	Korky Part#	Type
LAV450BP	450BP	Rubber

Tank Balls



- . Rubber tri seal tank ball
- . Rated to 160°F

Part No#	Size	Type
WALSTDTRIPPLESEAL	2-1/4"	Rubber
WAL3TRIPPLESEAL	3"	Rubber

Lift wires



- . For use on tri seal tank balls
- . Brass finish

Part No#	Description	Type
PASUPPERWIRE9	Upper Lift Wire	Brass
PASLOWERWIRE51/2	Lower Lift Wire	Brass

Rubber Urinal Gasket



- . Replacement rubber gasket for urinals

Part No#	Type	Type
PASG601TANKGASKET	Urinal Gasket	Rubber

Rubber Tank To Bowl Gaskets



- . Fits American Standard Cadet, Kohler, Crane, Borg Warner

Part No#	Type	Type
PASG605TANKGASKET	Universal Gasket	Rubber

Gerber Rubber Tank To Bowl Gasket



- . Replacement tank to bowl gasket for Gerber toilets (except Ultra Flush)

Part No#	Type	Type
WALG604TANKGASKET	Gerber Gasket	Rubber

Tank To Bowl Gasket For Gerber Ultra Flush Closet



- . Replacement rubber gasket for Gerber 28-380 tank

Part No#	Geber Part#	Color
GER99-591	99-591	Green

Brass Urinal/Closet Spuds



- . Cast brass spud
- . Includes spud gasket and friction ring



Part No#	Size	Type
PASURINALSPUD1X3/4	1" x 3/4"	Urinal
PASCLOSETSPUD11/4	1-1/4"	Urinal/Closet
PASCLOSETSPUD11/2	1-1/2"	Closet
PASCLOSETSPUD2	2"	Closet
PASCLOSETSPUD2X11/2	2" x 1-1/2"	Closet

Lavelle Universal Flapper



- . Universal fit for most 2" flush valves
- . Flexible rubber

Part No#	Lavelle Part#	Size
LAV52BAGBLUE	52BAG	2"

Korky Basic Universal Flapper



- . Universal fir for most 2" flush valves
- . Flexible rubber
- . Includes stainless steel chain

Part No#	Korky Part#	Size
LAV54BP	54BP	2"

Korky Plus Universal Flapper



- . Universal fit for most 2" flush valves
- . Flexible chlorine resistant rubber
- . Includes stainless steel chain

Part No#	Korky Part#	Size
LAV2001BP	2001BP	2"

Korky Float Style Universal Flapper



- . Universal fir for most 2" flush valves
- . Includes Float
- . Flexible chlorine resistant rubber
- . Includes stainless steel chain

Part No#	Korky Part#	Type
LAV2004BP	2004BP	2"

Korky Classic Flapper



- . Designed to fit old style 5 and 7 gallon toilets
- . Flexible Rubber
- . Includes stainless steel chain

Part No#	Korky Part#	Type
LAV2000BP	2000BP	2"

Korky Shark Fin Flapper For Kohler



- . Designed to fit specific Kohler one piece toilets
- . Rialto, San Raphael, Santa Rosa, Revival and Gabrielle
- . Flexible chlorine resistant rubber
- . Includes stainless steel chain

Part No#	Korky Part#	Type
LAV2012BP	2012BP	2"

Korky Hinged Flapper For Kohler



- . Designed to fit specific Kohler one piece toilets
- . Ankara, Fables and Flowers, Laureate, Prairie Flowers, San Rafael, Revival, Rialto and Rosario
- . Flexible chlorine resistant rubber
- . Includes stainless steel chain

Part No#	Korky Part#	Type
LAV2011BP	2011BP	2"

Korky Float Flapper For Kohler



- . Designed to fit specific Kohler one piece toilets
- . Cabernet, Fables and Flowers, Laureate, Palarre, Pillow Talk, Prairie Flowers, Rialto, Rochelle, Rosario, San Martine, San Miguel and San Raphael
- . Flexible chlorine resistant rubber

Part No#	Korky Part#	Type
LAV2010BP	2010BP	2"

Korky Flush Ball Flapper For Kohler



- . Designed to fit specific Kohler one piece and two piece toilets
- . Palarre, Rialto, Rochelle, San Miguel, San Raphael, Bolton, Cayuga, Evensong, Highline, Jamboree, Solstice, Vintage, Wellesley, Wellington and Wellworth
- . Flexible chlorine resistant flapper

Part No#	Korky Part#	Type
LAV58BP	58BP	2"

Flapper For Gerber Closets



- . Fits any Gerber toilet with a 3" flush valve
- . Includes stainless steel chain

Part No#	Geber Part#	Size
GER99-770	99-770	3"

Korky Large 3" Universal Flapper



- . Adjustable and universal to fit most 3" flush valves
- . Flexible chlorine resistant rubber
- . Includes stainless steel chain

Part No#	Korky Part#	Type
LAV3060BP	3060BP	3"

FLAPPERS

Korky Genuine Flapper For Toto



- . Adjustable to fit all Toto toilets with a 3" flush valve
- . Flexible chlorine resistant rubber
- . Includes stainless steel chain

Part No#	Korky Part#	Type
LAV2023BP	2023BP	3"

Korky Power Gravity Flapper For Toto



- . Designed to fit most Power Gravity Toto toilets
- . Includes stainless steel chain

Part No#	Korky Part#	Size
LAV2022BP	2022BP	3"

Korky G-MAX Flapper For Toto



- . Designed to fit most G-MAX Toto toilets
- . Flexible chlorine resistant rubber
- . Includes stainless steel chain

Part No#	Korky Part#	Size
LAV2021BP	2021BP	3"

Hard Plastic Toilet Shim



- . Rigid plastic material
- . Can be stacked
- . Can be driven

Part No#	Type	Qty
SIOWEDGEIT	Plastic	Each

Soft Rubber Toilet Shim



- . Soft rubber material
- . Can be stacked
- . Easy to cut with knife

Part No#	Type	Qty
SIOWEDGEITSOFT	Rubber	Each

Regal Top Spud Flush Valve



- . Durable high copper, low zinc brass castings
- . Adjustable tailpiece
- . Screwdriver shut off valve

Part No#	Fixture	GPF
SLO186.5	Urinal	0.5
SLO186XL	Urinal	1.5
SLO111XL	Closet	1.6
SLO180XL	Urinal	3.5
SLO110XL	Closet	3.5

Sensor Activated Side Mount Flushometer



- . Replaces handle on any Sloan Regal flush valve
- . Estimated 3 year battery life
- . Manual flush button for sensor override

Part No#	Sloan Part#	Type
SLOEBV500A	EBV-500-A	Chrome

Sloan Vacuum Breaker Rebuild Kit



- . Replaces all Sloan Regal flushometer vacuum breakers
- . Allows water to flow down through it but acts as a one way valve not allowing water to siphon back up

Part No#	Sloan Part#	Type
SLOV551A	V-551-A	Rubber

Sloan High Back Vacuum Breaker Rebuild Kit



- . Replaces all Sloan Regal flushometer vacuum breakers
- . Allows water to flow down through it but acts as a one way valve not allowing water to siphon back up
- . To be used with low consumption fixtures with high pressure

Part No#	Sloan Part#	Type
SLOV651A	V-651-A	Rubber

Sloan Handle Assembly



- . Replaces all Sloan Royal and Regal flushometer handles

Part No#	Sloan Part#	Type
SLOB32A	B-32-A	Metal

Sloan Handle Rebuild Kit



- . Rebuilds all Sloan Royal and Regal flushometer handles
- . Located between metal handle and flushometer body

Part No#	Sloan Part#	Type
SLOB50A	B-50-A	Rebuild Kit

Replacement Diaphragms For Sloan Regal Valves



- . Pre-assembled drop in kit replaces most diaphragm kits
- . The replacement of this assembly will fix a majority of flushometer malfunctions

Part No#	Type	GPF
SLOA36A	Closet	4.5
SLOA37A	Urinal	1.5
SLOA38A	Closet	3.5
SLOA41A	Closet	1.6
SLOA42A	Urinal	1.0
SLOA43A	Urinal	0.5

Replacement Diaphragms For Sloan Optima Valves



- . Replacement Diaphragm for Sloan G2 Optima series
- . The replacement of this assembly will fix a majority of flushometer malfunctions

Part No#	Type	GPF
SLOEBV1020A	Closet	1.6
SLOEBV1022A	Urinal	1.0

Replacement Solenoid For Sloan G2 Modules



- . Replacement solenoid for Sloan G2 series
- . Fits post 2003 modules

Part No#	Sloan Part#	Type
SLOEBV136A	EBV-136-A	Metal

Vacuum Breaker Tubes



- . Replacement tube for any Sloan Royal and Regal flushometers
- . Prevents grey water from contaminating fresh water supply
- . Vacuum breaker kit included

Part No#	Size	Length
SLOV500AA3/4X9	3/4"	9"
SLOV500AA3/4X15	3/4"	15"
SLOV500AA11/4X9	1-1/4"	9"
SLOV500AA11/2X9	1-1/2"	9"
SLOV500AA11/2X131/2	1-1/2"	13-1/2"

SLOAN PARTS

Sloan Adjustable Tailpiece



- . Replacement for any Sloan tailpiece
- . Chrome Finish
- . Variety of lengths to fit different roughs

Part No#	Sloan Part#	Size
SLOH551A41/16	H-551-A 4 1/16	4-1/16"
SLOH551A31/16	H-551-A 3 1/16	3-1/16"
SLOH551A21/16	H-551-A 2 1/16	2-1/16"

Sloan Replacement Stop Valves



- . Replacement stop valve for Sloan flush valves

Part No#	Sloan Part#	Size
SLOH790A3/4	3308875	3/4"
SLOH790A1	3308876	1"

Sloan Stop Valve Rebuild Kit



- . Replacement kit for stop valve internals
- . A single flat head screwdriver will open and close the valve
- . 3/4" - fits urinal
- . 1-1/2" - fits closet

Part No#	Sloan Part#	Size
SLOH543	H-543-A	3/4"
SLOH541	H-541-A	1"

Sloan Soldering Kit



- . Soldering kit includes tube, bushing and wall escutcheon

Part No#	Sloan Part#	Size
SLOH536AS	H536AS	3/4"
SLOH553AS	H534AS	1"

Sloan Replacement Piston



- . Replacement piston for Sloan flushometers
- . Includes main seat

Part No#	Sloan Part#	Type
SLOCN1002A	CN-1002-A	Closet
SLOCN1003A	CN-1003-A	Urinal

Sloan Rubber Gasket For Spud Coupling



- . Replacement rubber gasket for Sloan spud coupling
- . 3/4" - fits urinal
- . 1-1/2" - fits urinal

Part No#	Sloan Part#	Size
SLOF53/4	F53/4	3/4"
SLOVBF511/2	VBF511/2	1-1/2"

Sloan Friction Ring For Spud Coupling

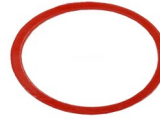

- . Replacement friction ring for Sloan spud coupling
- . 3/4" - fits urinal
- . 1-1/2" - fits closet

Part No#	Sloan Part#	Size
SLOF33/4	F33/4	3/4"
SLOF311/2	F311/2	1-1/2"

Sloan Spud Coupling Rebuild Kit



- . Rebuild kit for any Sloan flushometer
- . 3/4 - fits urinal
- . 1-1/2" - fits closet

Part No#	Sloan Part#	Size
SLOF54A	F54A	3/4"
SLOF5AU11/4	F5AU	1-1/4"
SLOF56A	F56A	1-1/2"

Sloan Vacuum Breaker Coupling Assembly



- . Replacement coupling for any Sloan flushometer

Part No#	Sloan Part#	Type
SLOV553A	V-553-A	Metal

Replacement O-Ring For Sloan Tailpiece



- . Replacement O-ring for Sloan flushometers
- . Fits over the adjustable tailpiece

Part No#	Sloan Part#	Type
SLOH553	H553	Rubber

SLOAN PARTS

Sloan Cap For Regal Flushometer



- . Replacement cap for Sloan Regal flushometer
- . Chrome finish

Part No#	Sloan Part#	Type
SLOR10	R10	Chrome

Sloan Plastic Inside Cover



- . Replacement cover for all Sloan flushometers
- . Sits on top of diaphragm under the chrome cap

Part No#	Sloan Part#	Type
SLOA71	A71	Plastic

Sloan Handle Nut



- . Replacement handle nut for any Sloan flushometer
- . Chrome finish

Part No#	Sloan Part#	Type
SLOA6	A6	Chrome

Sloan Chrome Cap



- . Replacement cap for any Sloan flushometer

Part No#	Sloan Part#	Type
SLOH37	H37	Chrome

Tailpiece Tool For Flushometers



- . Fits Sloan, Zurn and Delaney flushometers
- . Used to adjust or remove tailpieces
- . May also be called the "Spud Buddy"

Part No#	Walrich Part#	Type
WALSLOANWRENCH	1851000	Tool

Sloan Flushmate Cartridge



- . Universal fit for all flushmate cylinders
- . Standard flow cartridge

Part No#	Sloan Part#	Type
SLOC100500K	C100500K	Plastic

Sloan Flushmate Cartridge Wrench



- . Universal to fit all flushmate cartridges
- . Can also be used to tighten or remove supply nut on tank
- . Can also be used to tighten or remove large cylinder nut

Part No#	Sloan Part#	Type
SLOST100100	ST100100	Tool

Chicago Metering Urinal Valve



- . 3/4" OD outlet
- . Includes slip wall flange
- . Polished chrome finish

Part No#	Chicago Part#	Type
CHI732VB665PSHCP	732-VBCP	Angle
CHI733VB665PSHCP	733-VBCP	Straight

Madison Heights Plumbing & Heating Supply

SECTION 2 - SINKS

China Sinks	22
Stainless Sinks/Commercial	23-25
Delta Faucets & Parts.....	26-32
Chicago Faucets & Parts	33-35
T & S Faucets & Parts	36-38
Basket Strainers	39-40
Supply Lines	41
Garbage Disposals	42-43
Instahots	44
Supply Valves	45-46

Gerber Monticello ADA Wall Hung Sink



- . Total outer dimensions: 20-1/4" x 18-1/2"
- . Drilled for a 4" spread faucet
- . Back overflow hole
- . Meets ADA standards

Part No#	Gerber Part#	Holes
GER12-654	12-654	3

Gerber West Point Space Saving Wall Hung Sink



- . Total outer dimensions: 14" x 12"
- . Drilled for a 4" spread faucet
- . Front overflow hole

Part No#	Gerber Part#	Holes
GER12-354	12-354	3

Gerber Hayes Wall Hung Sink



- . Total outer dimensions: 20" x 18"
- . Drilled for a 4" spread faucet
- . Front overflow hole
- . Optional for use with Concealed Chair Carrier

Part No#	Gerber Part#	Holes
GER12-384	12-384	3

Gerber Plymouth ADA Wall Hung Sink



- . Total outer dimensions: 19" x 17"
- . Drilled for a 4" spread faucet
- . Back overflow hole
- . Meets ADA standards

Part No#	Gerber Part#	Holes
GER12-314	12-314	3

Gerber Maxwell Oval Drop In Sink



- . Total outer dimensions: 20" x 17-7/8"
- . Drilled for a 4" spread faucet
- . Front overflow hole
- . Meets ADA standards

Part No#	Gerber Part#	Holes
GER12-834CH	12-834-CH	3

Gerber Maxwell Round Drop In Sink



- . Total outer dimensions: 19-1/4"
- . Drilled for a 4" spread faucet
- . Front overflow hole
- . Meets ADA standards

Part No#	Gerber Part#	Holes
GER12-884CH	12-884-CH	3

Gerber Maxwell Oval Widespread Drop In Sink



- . Total outer dimensions: 21" x 17-7/8"
- . Drilled for a 8" spread faucet
- . Front overflow hole
- . Meets ADA standards

Part No#	Gerber Part#	Holes
GER12-838CH	12-838-CH	3

Gerber Maxwell Petite Pedestal Sink



- . Total outer dimensions: 21" x 18"
- . Drilled for a 4" spread faucet
- . Front overflow hole
- . For residential use only

Part No#	Gerber Part#	Components
GER12-504	12-504	Lavatory
GER29-842	29-842	Base

Gerber Maxwell Widespread Pedestal Sink



- . Total outer dimensions: 25-1/2" x 20-1/2"
- . Drilled for a 8" spread faucet
- . Front overflow tube
- . For residential use only

Part No#	Gerber Part#	Components
GER12-518	12-518	Lavatory
GER29-842	29-842	Base

Gerber Maxwell Standard Pedestal Sink



- . Total outer dimensions: 25-1/2" x 20-1/2"
- . Drilled for a 4" spread faucet
- . Front overflow tube
- . For residential use only

Part No#	Gerber Part#	Components
GER12-514	12-514	Lavatory
GER29-842	29-842	Base

Bracket For Gerber Wall Hung Sink & Urinal



- . Replacement bracket for Gerber wall hung china sinks
- . Bracket will also work for Gerber urinal 27-740

Part No#	Gerber Part#	Type
GER99-161	99-161	Metal

STAINLESS STEEL SINKS

Dayton Stainless Steel Sinks - "D" Series



- . Drop In stainless steel sink
- . Satin finish
- . 23 Gauge
- . Sound deadening bottom pads

NOTE: SPECIFY NUMBER OF HOLES UPON ORDERING

Part No#	Elkay Part#	Holes	Drain Size	Outer Dimensions	Bowl 1 Dimensions	Bowl 2 Dimensions
DAYD11515-1	D11515-1	1	2"	15" x 15" x 5-3/16"	12" x 10" x 5"	
DAYD11515-2	D11515-2	2	2"	15" x 15" x 5-3/16"	12" x 10" x 5"	
DAYD11516-1	D11516-1	1	3-1/2"	15" x 15" x 5-3/16"	12" x 10" x 5"	
DAYD11516-2	D11516-2	2	3-1/2"	15" x 15" x 5-3/16"	12" x 10" x 5"	
DAYD1719-1	D1719-1	1	3-1/2"	17" x 19" x 6-3/16"	14" x 14" x 6"	
DAYD1719-2	D1719-2	2	3-1/2"	17" x 19" x 6-3/16"	14" x 14" x 6"	
DAYD1719-3	D1719-3	3	3-1/2"	17" x 19" x 6-3/16"	14" x 14" x 6"	
DAYD1721-1	D1721-1	1	3-1/2"	17" x 21-1/4" x 6-1/2"	14" x 15-3/4" x 6-3/8"	
DAYD1721-2	D1721-2	2	3-1/2"	17" x 21-1/4" x 6-1/2"	14" x 15-3/4" x 6-3/8"	
DAYD1721-3	D1721-3	3	3-1/2"	17" x 21-1/4" x 6-1/2"	14" x 15-3/4" x 6-3/8"	
DAYD12522-3	D12522-3	3	3-1/2"	25" x 22" x 6-9/16"	21" x 15-3/4" x 6-3/8"	
DAYD12522-4	D12522-4	4	3-1/2"	25" x 22" x 6-9/16"	21" x 15-3/4" x 6-3/8"	
DAYD23322-3	D23322-3	3	3-1/2"	33" x 22" x 6-9/16"	14" x 15-3/4" x 6-3/8"	14" x 15-3/4" x 6-3/8"
DAYD23322-4	D23322-4	4	3-1/2"	33" x 22" x 6-9/16"	14" x 15-3/4" x 6-3/8"	14" x 15-3/4" x 6-3/8"

Dayton Stainless Steel Sinks - "DSE" Series



- . Drop In stainless steel sink
- . Satin finish
- . 20 Gauge
- . Sound deadening bottom pads

NOTE: SPECIFY NUMBER OF HOLES UPON ORDERING

Part No#	Elkay Part#	Holes	Drain Size	Outer Dimensions	Bowl 1 Dimensions	Bowl 2 Dimensions
DAYDSE12522-1	DSE12522-1	1	3-1/2"	25" x 22" x 8-1/16"	21" x 15-3/4" x 8"	
DAYDSE12522-3	DSE12522-3	3	3-1/2"	25" x 22" x 8-1/16"	21" x 15-3/4" x 8"	
DAYDSE12522-4	DSE12522-4	4	3-1/2"	25" x 22" x 8-1/16"	21" x 15-3/4" x 8"	
DAYDSE23319-3	DSE23319-3	3	3-1/2"	33" x 19" x 8"	14" x 14" x 7-7/8"	14" x 14" x 7-7/8"
DAYDSE23319-4	DSE23319-4	4	3-1/2"	33" x 19" x 8"	14" x 14" x 7-7/8"	14" x 14" x 7-7/8"
DAYDSE23322-3	DSE23322-3	3	3-1/2"	33" x 22" x 8-1/16"	14" x 15-3/4" x 7-7/8"	14" x 15-3/4" x 7-7/8"
DAYDSE23322-4	DSE23322-4	4	3-1/2"	33" x 22" x 8-1/16"	14" x 15-3/4" x 7-7/8"	14" x 15-3/4" x 7-7/8"

Sink Clips & Screwdriver



- . Replacement sink clips and screws for Elkay sinks

Part No#	Description	Size
WALELKAYSHORTSCREW	Sink Screw & Clip Kit	—
WALELKAYLONGSCREW	Long Sink Screw & Clip Kit	—
ELKCLK350	Sink Clip Screwdriver	10-1/4 Shank

- . Long stem for hard to reach sink clip screws
- . Plastic handle



Faucet Hole Cover



- . Chrome plated top
- . Toggle style nut

Part No#	Size	Finish
PASCPFAUCETHOLECOVE	1-5/8"	Chrome

Stainless Steel Hand Sink Kit With Faucet



- . Wall mount hand sink with splashguard
- . Includes BKF-W-3G-G faucet

Part No#	BK Part#	Finish
BKHANDSINKSSKIT	HSB-W-1410-P-G	Stainless Steel

Replacement Faucet For Hand Sink Kit



- . 4" spread
- . Gooseneck spout

Part No#	BK Part#	Finish
BK4"HANDSINKFAUCET	BKF-W-3G-G	Chrome

Fiberglass Mop Service Basin



- . High impact resistant fiberglass
- . Includes drain gasket for 3" PVC
- . Includes removable strainer
- . Easy to install

Part No#	Mustee Part#	Size
MUS63M	63M	24" x 24"
MUS65M	65M	24" x 36"

Rubber Gasket For Mop Service Basin



- . Part# 65.309 adapts drain size to 3" PVC
- . Part# 65.308 adapts drain size to 2" PVC

Part No#	Mustee Part#	Size
MUSSTDGASKET	65.309	3"
MUS3X2GASKET	65.308	3" x 2"

Soil Pipe Gasket For Mop Service Basin



- . Adapts drain size to 3" No Hub pipe

Part No#	Mustee Part#	Size
MUS3SOILGASKET	65.311	3"

Chicago Mop Service Basin Faucet



- . 8" centers, adjustable 7-5/8"- 8-3/8" arms
- . Ceramic 1/4 turn cartridges
- . Cast brass construction

Part No#	Chicago Part#	Finish
CHI897RCF	897-RCF	Chrome

Chicago Vacuum Breaker



- . Chrome finish
- . Vacuum breaker kit includes cover and screw

Part No#	Chicago Part#	Type
CHI892-254KJKABCP	892-254	Vacuum Breaker
CHI892-302KJKABNF	892-302	V.B Rebuild Kit

Delta Mop Service Basin Faucet Parts

Part No#	Delta Part#	Item Description
DEL060034A	060034A	Replacement Stem
DEL060302A	060302A	VB Kit

Rosette Washer



- . Used for securing a wall mount faucet to a back mount sink
- . Available in both shallow and deep patterns
- . Fits 1/2 IPS

Part No#	Style	Type
WALTHINCROWFOOT	Shallow	Metal
WALTHICKCROWFOOT	Deep	Metal

Faucet Basin Nut



- . Brass faucet basin nut to be used with any poly supply tube

Part No#	Size	Type
WALBASINNUTBRASS	1/2" FPT	Brass

INDIRECT WASTE SINKS

Heavy Duty Steel Grease Trap



- . Retains fat, oil & grease from waste water in a kitchen
- . Corrosion resistant steel
- . Includes flow control valve

Part No#	Gallons/Lbs	Size (Outlet/Inlet)
SMI800Y02-15	15/30	2"
SMI800Y03-20	20/40	3"
SMI800Y03-25	25/50	3"
SMI800Y03-35	35/70	3"

Plastic Square Slop Sink



- . Heavy duty plastic
- . Strainers and grates sold separately

Part No#	Size (Outer Dimensions)	Drain Size
IPSPVCSLOPSINK	12" x 12"	3" DWV

Cast Iron Square Slop Sink



- . Porcelain cast iron sink
- . Includes aluminum dome strainer

Part No#	Size (Outer Dimensions)	Drain Size
SMI320Y03	12" x 12"	3"
SMI320Y04	12" x 12"	4"

Plastic Round Slop Sink With Strainer



- . Heavy duty plastic
- . Includes round bottom strainer

Part No#	Size	Drain Size
JON12RDSLOPSINK	12" Round	3" DWV

Top Grate For Plastic Square Slop Sink



- . Heavy duty plastic
- . Fits the top of a 12" x 12" plastic square slop sink

Part No#	Type	Drain Size
IPSPVCTOPGRATE1/2	1/2 Top Grate	Any
IPSPVCTOPGRATE3/4	3/4 Top Grate	Any
IPSPVCTOPGRATEFULL	Full Top Grate	Any

Dome Strainer For Plastic Square Slop Sink



- . Aluminum dome strainer
- . Fits in the bottom of a 12" x 12" plastic square slop sink

Part No#	Description	Drain Size
IPSDOMESTRSLOPSINK	Aluminum Dome Strainer	3" DWV

Flat Strainer For Plastic Square Slop Sink

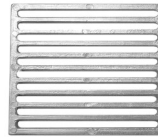

- . Aluminum flat strainer
- . Fits in the bottom of a 12" x 12" plastic square slop sink

Part No#	Description	Drain Size
JONFLATSTRSLOPSINK	Aluminum Flat Strainer	Any

Sioux Chief Plastic Square Slop Sink



- . Heavy duty PVC construction
- . Includes flange for easy mounting
- . Strainer not included

Part No#	Size	Drain Size
SIOPVCSQFLOORSINK3	12" x 12"	3" DWV

Delta Classic Single Handle Less Spray



- . Diamond Seal Technology allows for easy repair
- . 3-hole installation 8" spread
- . Includes integrated PEX supply tubes
- . Side spray not included

Part No#	Delta Part#	Finish
DEL100DST	100-DST	Chrome

Delta Classic Single Handle With Spray



- . Diamond Seal Technology allows for easy repair
- . 3-hole installation 8" spread
- . Includes integrated PEX supply tubes
- . Includes side spray

Part No#	Delta Part#	Finish
DEL400DST	400-DST	Chrome

Delta Collins Single Handle Less Spray



- . Diamond Seal Technology allows for easy repair
- . 3-hole installation 8" spread
- . Includes integrated PEX supply tubes
- . Includes side spray

Part No#	Delta Part#	Finish
DEL140DST	140-DST	Chrome
DEL140SSDST	140-SS-DST	Stainless Steel

Delta Collins Single Handle With Spray



- . Diamond Seal Technology allows for easy repair
- . 3-hole installation 8" spread
- . Includes integrated PEX supply tubes
- . Includes side spray

Part No#	Delta Part#	Finish
DEL440DST	440-DST	Chrome
DEL440SSDST	440-SS-DST	Stainless Steel

Delta Collins Single Handle With Integral Spray



- . Diamond Seal Technology allows for easy repair
- . 3-hole installation 8" spread
- . Includes integrated PEX supply tubes
- . Includes side spray built into mounting plate

Part No#	Delta Part#	Finish
DEL340DST	340-DST	Chrome

Delta Collins Single Handle Less Spray



- . Diamond Seal Technology allows for easy repair
- . Single hole installation
- . Includes integrated PEX supply tubes
- . Side spray not included

Part No#	Delta Part#	Finish
DEL141DST	141-DST	Chrome
DEL141SSDST	141-SS-DST	Stainless Steel

Delta Collins Single Handle With Spray



- . Diamond Seal Technology allows for easy repair
- . Single hole installation
- . Includes integrated PEX supply tubes
- . Includes side spray

Part No#	Delta Part#	Finish
DEL441DST	441-DST	Chrome
DEL441SSDST	441-SS-DST	Stainless Steel

Delta Cassidy Two Handle Gooseneck With Spray



- . High arc gooseneck spout
- . 3 or 4-hole installation 8" spread
- . Includes side spray

Part No#	Delta Part#	Finish
DEL2497LF	2497LF	Chrome
DEL2497LF-AR	2497LF-AR	Arctic Stainless

Delta Foundations Two Handle Less Spray



- . 3 or 4-hole installation 8" spread
- . Side spray not included

Part No#	Delta Part#	Finish
DELB2310LF	B2310LF	Chrome

Delta Foundations Two Handle With Spray



- . 3 or 4-hole installation 8" spread
- . Includes side spray

Part No#	Delta Part#	Finish
DELB2410LF	B2410LF	Chrome

Peerless Tunbridge Single Handle Pull Out Spray



- . 1 or 3-hole installation 8" spread
- . Includes integral pull out spray

PEERLESS

Part No#	Peerless Part#	Finish
PEEP18550LF	P18550LF	Chrome

DELTA KITCHEN FAUCETS/LAVATORY FAUCETS

Delta Pilar Single Handle With Spray



- . Diamond Seal Technology allows for easy repair
- . 3-hole installation 8" spread
- . Includes integrated PEX supply tubes
- . Includes side spray

Part No#	Delta Part#	Finish
DEL4380DST	4380-DST	Chrome
DEL4380ARDST	4380-AR-DST	Arctic Stainless

Delta Collins Single Handle Pull Out Spray



- . Diamond Seal Technology allows for easy repair
- . 1 or 3-hole installation 8" spread
- . Includes integrated PEX supply tubes
- . Includes mounting plate for optional 3 hole installation

Part No#	Delta Part#	Finish
DEL4140DST	4140-DST	Chrome
DEL4140ARDST	4140-AR-DST	Arctic Stainless

Delta Signature Single Handle Pull Out Spray



- . Diamond Seal Technology allows for easy repair
- . 1 or 3-hole installation 8" spread
- . Includes integrated PEX supply tubes
- . Includes mounting plate for optional 3 hole installation

Part No#	Delta Part#	Finish
DEL470DST	470-DST	Chrome
DEL470ARDST	470-AR-DST	Arctic Stainless

Delta Trinsic Gooseneck With Pull Out Spray



- . Diamond Seal Technology allows for easy repair
- . Single hole installation 8" spread
- . Includes integrated PEX supply tubes

Part No#	Delta Part#	Finish
DEL9159DST	9159-DST	Chrome
DEL9159ARDST	9159-AR-DST	Arctic Stainless

Delta Addison Gooseneck With Pull Out Spray



- . Diamond Seal Technology allows for easy repair
- . Single hole installation 8" spread
- . Includes integrated PEX supply tubes

Part No#	Delta Part#	Finish
DEL9192DST	9192-DST	Chrome
DEL9192ARDST	9192-AR-DST	Arctic Stainless
DEL9192RBDST	9192-RB-DST	Oil Rubbed Bronze

Delta Leland Single Handle Pull Out Spray



- . Diamond Seal Technology allows for easy repair
- . 2-hole installation
- . Includes integrated PEX supply tubes

Part No#	Delta Part#	Finish
DEL978DST	978-DST	Chrome
DEL978ARDST	978-AR-DST	Arctic Stainless

Delta Foundations Single Handle



- . 3-hole 4" spread
- . Includes metal pop up assembly

Part No#	Delta Part#	Finish
DELB510LF	B510LF	Chrome
DELB510LFSS	B510LF-SS	Stainless Steel

Delta Classic Single Handle



- . Diamond Seal Technology allows for easy repair
- . 3-hole 4" spread
- . Includes metal pop up assembly

Part No#	Delta Part#	Finish
DEL520MPUDST	520-MPU-DST	Chrome
DEL520SSMPUDST	520-SSMPU-DST	Stainless Steel

Peerless Parkwood Single Handle



- . 1 or 3-hole 4" spread
- . Includes metal pop up assembly
- . Includes mounting plate for optional 3-hole installation

Part No#	Peerless Part#	Type
PEELAVFAUCET	P1535LF	Chrome

Delta Lahara Single Handle



- . Diamond Seal Technology allows for easy repair
- . 1 or 3-hole 4" spread
- . Includes metal pop up assembly
- . Includes mounting plate for optional 3-hole installation

Part No#	Delta Part#	Finish
DEL538MPUDST	538-MPU-DST	Chrome
DEL38SSMPUDST	538-SSMPU-DST	Stainless Steel

Delta Dryden Single Handle



- . Diamond Seal Technology allows for easy repair
- . 1 or 3-hole 4" spread
- . Includes metal pop up assembly
- . Includes mounting plate for optional 3-hole installation

Part No#	Delta Part#	Finish
DEL551DST	551-DST	Chrome
DEL551SSDST	551-SS-DST	Stainless Steel

Delta Foundations Two Handle



- . 3-hole 4" spread
- . Includes metal pop up assembly

Part No#	Delta Part#	Finish
DELB2510LF	B2510LF	Chrome
DELB2510LFSS	B2510LF-SS	Stainless Steel

Delta Lahara Two Handle



- . Diamond Seal Technology allows for easy repair
- . 3-hole 4" spread
- . Includes metal pop up assembly
- . Taller ridged spout

Part No#	Delta Part#	Finish
DEL2538MPUDST	2538-MPU-DST	Chrome
DEL2538SSMPUDST	2538-SSMPU-DST	Stainless Steel

Delta Dryden Two Handle



- . Diamond Seal Technology allows for easy repair
- . 3-hole 4" spread
- . Includes metal pop up assembly
- . Taller ridged spout

Part No#	Delta Part#	Finish
DEL2551MPUDST	2551-MPU-DST	Chrome
DEL2551SSMPUDST	2551-SSMPU-DST	Stainless Steel

Delta Lahara Two Handle Widespread



- . Diamond Seal Technology allows for easy repair
- . 3-hole 8" spread
- . Includes metal pop up assembly
- . Taller ridged spout

Part No#	Delta Part#	Finish
DEL3538MPUDST	3538-MPU-DST	Chrome
DEL3538SSMPUDST	3538-SSMPU-DST	Stainless Steel

Delta Dryden Two Handle Widespread



- . Diamond Seal Technology allows for easy repair
- . 3-hole 8" spread
- . Includes metal pop up assembly
- . Taller ridged spout

Part No#	Delta Part#	Finish
DEL3551LF	3551LF	Chrome
DEL3551LFSS	3551LF-SS	Stainless Steel

Delta Woodhurst Two Handle Widespread



- . 3-hole 8" spread
- . Includes metal pop up assembly
- . Taller ridged spout

Part No#	Delta Part#	Finish
DEL3532LFMPU	3532LF-MPU	Chrome
DEL3532LFSSMPU	3532LF-SSMPU	Stainless Steel
DEL3532LFRBMPU	3232LF-RBMPU	Oil Rubbed Bronze

DELTA COMMERCIAL LAVATORY FAUCETS

Delta Commercial Single Handle



- . Diamond Seal Technology allows for easy repair
- . 2 or 3-hole 4" spread
- . Grid strainer sold separately

Part No#	Delta Part#	Finish
DEL501LFHDF	501LF-HDF	Chrome

Delta Innovations Sensor



- . Battery operated sensor
- . 3-hole 4" spread
- . Vandal resistant

Part No#	Delta Part#	Finish
DEL591LFLGHGMHDF	591-LGHGMHDF	Chrome
DELRP36203	RP36203	Extension Kit

Delta Commercial Single Handle



- . Single hole installation
- . No pop up hole

Part No#	Delta Part#	Finish
DEL22C601	22C601	Chrome
DELRP34322	RP34322	Replacement Stem

Delta Commercial Two Handle Gooseneck



- . 2-hole 4" spread
- . Includes commercial blade handles
- . Gooseneck spout

Part No#	Delta Part#	Finish
DEL27C4842	27C4842	Chrome

Delta Commercial Two Handle Gooseneck



- . 3-hole 8" spread
- . Includes commercial blade handles
- . Gooseneck spout

Part No#	Delta Part#	Type
DEL26C3932	26C3932	Chrome

Delta Commercial Two Handle Gooseneck



- . 2-hole 4" spread
- . Includes commercial blade handles
- . Gooseneck spout

Part No#	Delta Part#	Finish
DEL27C4942	27C4942	Chrome

Delta Commercial Two Handle



- . 3-hole 4" spread
- . Includes commercial blade handles
- . Standard spout

Part No#	Delta Part#	Finish
DEL2529LFLGHDF	2529LF-LGHDF	Chrome

Delta Commercial Two Handle Widespread



- . 3-hole 8"-16" spread
- . Includes commercial blade handles
- . Standard spout

Part No#	Delta Part#	Finish
DEL3549WFLGHDF	3549LF-WFLGHDF	Chrome

Delta Commercial Single Handle Bar Prep Faucet



- . Diamond Seal Technology allows for easy repair
- . 2-hole 4" spread
- . Standard metal lever handle
- . Gooseneck spout

Part No#	Delta Part#	Finish
DEL710LFHDF	710LF-HDF	Chrome

Delta Foundations Two Handle Bar Prep Faucet



- . 2 or 3-hole 4" spread
- . High arc gooseneck spout

Part No#	Delta Part#	Finish
DELB28910LF	B28910LF	Chrome

Delta Commercial Faucet Replacement Stems



- . Replacement stems for Delta commercial Cambridge style faucets

Part No#	Delta Part#	Type
DEL063000A	063000A	Right Hand/Cold
DEL063001A	063001A	Left Hand/Hot

Single Handle Lavatory With Pop Up



- . Solid brass body
- . Brass pop up assembly



Part No#	Everflow Part#	Finish
EVE17344LAV	BAR-V11C	Chrome

Two Handle Lavatory With Pop Up



- . Decorative solid brass lever handles
- . Solid brass body
- . Brass pop up assembly



Part No#	Everflow Part#	Finish
EVE17146LAV	BGL-B11C	Chrome

Single Handle Kitchen Less Spray



- . Solid brass handle
- . Includes 3 hole mounting plate



Part No#	Everflow Part#	Finish
EVE17381KITCHEN	BAR-K10C	Chrome

Single Handle Kitchen With Spray



- . Solid brass handle
- . Includes 3 hole mounting plate
- . Plastic side spray nozzle



Part No#	Everflow Part#	Finish
EVE17382KITCHEN	BAR-K11C	Chrome

Two Handle Gooseneck Kitchen Less Spray



- . Two handle lever handles
- . Gooseneck spout



Part No#	Everflow Part#	Finish
EVE17187KITCHEN	BGL-G10C	Chrome

Two Handle Gooseneck Kitchen With Spray



- . Two handle lever handles
- . Gooseneck spout
- . Includes side spray nozzle



Part No#	Everflow Part#	Finish
EVE17188G	BGL-G11C	Chrome

Delta Soap/Lotion Dispenser



- . Includes 13oz bottle and refill funnel

Part No#	Delta Part#	Finish
DELRP1001	RP1001	Chrome
DELRP1001SS	RP1001SS	Stainless Steel
DELRP1001AR	RP1001AR	Arctic Stainless

Repair Parts For Delta Kitchen "DST" Faucets



- . Replacement parts for Delta "DST" style kitchen faucets

Part No#	Delta Part#	Item Description
DELRP50587	RP50587	DST Cartridge
DELRP25	RP25	O-Rings

Delta Single Handle Lavatory Faucet Rebuild Kit

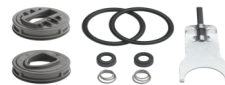

- . Genuine rebuild kit for Delta single handle lavatory faucets

Part No#	Delta Part#	Item Description
DELRP3614	RP3614	Rebuild Kit

Delta Faucet Seat And Spring Kit



- . Replacement seats and springs for Delta faucets

Part No#	Delta Part#	Item Description
DELRP4993	RP4993	4 Seats & Springs
DELRP4039	RP4039	24 Seats & Springs

Delta Faucet Ball Assembly



- . Delta RP70 - Replaces lever style handle faucets
- . Delta RP212 - Replaces crystal handle style faucets

Part No#	Delta Part#	Type
DELRP70	RP70	Plastic Ball
DELRP212	RP212	Brass Ball

Delta Two Handle Faucet Stems



- . Delta RP1740 - Plastic cartridge for two handle faucets
- . For ordering 6 or more, use part# RP1740MBS
- . Delta RP25513 - Brass cartridge for two handle faucet with 1/4 turn style handles

Part No#	Delta Part#	Item Description
DELRP1740	RP1740	Plastic Cartridge
DELRP25513	RP25513	Brass Cartridge

Delta Faucet Locknuts



- . Replacement locknuts for Delta faucets
- . Includes two plastic locknuts

Part No#	Delta Part#	Type
DELRP6183	RP6183	Plastic

Delta Faucet Extension Kits



- . Delta RP10612 - To be used with Delta widespread lavatory faucets
- . Delta RP30392 - For use with Delta Kitchen Faucets

Part No#	Delta Part#	Type
DELRP10612	RP10612	Widespread
DELRP30392	RP30392	Kitchen Faucet Kit

Universal Faucet Aerators



- . 15/16" Male x 55/64" Female
- . Specify upon ordering overflow or no overflow

Part No#	Description	Type
PASAERATORSINGLE	Universal Aerator	Chrome
PASAERATORTUBE	Aerator Tube Of 6	Chrome

Gerber Ceramic Two Handle Faucet Cartridge



- . Replacement cartridge for Gerber two handle kitchen and lavatory faucets

Part No#	Gerber Part#	Type
GER86-986	86-986	Cold stem
GER86-987	86-987	Hot stem

Gerber Faucet Blade Handles



- . Replacement handles for Gerber kitchen and lavatory faucets

Part No#	Gerber Part#	Type
GER98-879	98-879	Blade Handles

Moen Single Handle Faucet Replacement Cartridge



- . Compatible with Moen #1200
- . Replacement for most Moen single handle faucets and showers prior to 1990

Part No#	Walrich Part#	Type
WALBRASSCART	4304704	Brass



- . Compatible with Moen #1225
- . Replacement for most Moen single handle faucets and showers

Part No#	Walrich Part#	Type
WALPLASTICCART	1304702	Plastic

Moen Two Handle Faucet Replacement Cartridge



- . Compatible with Moen #1224
- . Replacement for most Moen two handle faucets

Part No#	Walrich Part#	Type
WALMOEN1224	1304712	Plastic

Rubber O-Ring Assortment Kit



- . Assortment of common O-ring sizes
- . Reusable box

Part No#	Type	Pieces
LAVK200	O-Ring Kit	200

Rubber Washer Assortment Kits



- . Assortment of common washer sizes
- . Reusable box

Part No#	Type	Pieces
LAV149	Beveled	200

Rubber Washer & Bibb Screw Assortment Kit



- . Assortment of common washer sizes (200)
- . Assortment of brass bibb screws (50)
- . Reusable box

Part No#	Type	Pieces
WALFLATWASHKIT	Flat	250

Red Rubber Gasket Material



- . Durable rubber material
- . Cut to size to make your own gaskets

Part No#	Size	Material
WALGASKETMAKER	6" x 6" x 3/32"	Red Rubber

Graphite Packing



- . Black spool of graphite packing

Part No#	Size	Length
WALGRAPHITEPACKING	1/8"	12'

LOOKING FOR A FAUCET PART NOT LISTED IN THIS CATALOG? GIVE US A CALL! WE MAY STILL HAVE IT!

CHICAGO FAUCETS

Two Handle Deck Mount With Gooseneck



- . 4" spread
- . 3-1/2" gooseneck spout
- . Standard lever handles

Part No#	Chicago Part#	Finish
CHI895ABCP	895-ABCP	Chrome

Chicago Mop Service Basin Faucet



- . Wall mount 8" spread
- . Standard lever handles
- . 1/4 turn ceramic cartridges

Part No#	Chicago Part#	Finish
CHI897RCF	897-RCF	Chrome

Two Handle Single Hole Deck Mount With Spout



- . Single hole installation
- . 5-1/4" gooseneck spout
- . Standard lever handles

Part No#	Chicago Part#	Finish
CHI50ABCP	50-ABCP	Chrome

Inside Sill Fitting



- . 2-1/4" tee style handle

Part No#	Chicago Part#	Finish
CHI293RCF	293-RCF	Chrome
CHI387RCF	387-RCF	Chrome

Two Handle Wall Mount Adjustable Faucet



- . 2-3/8" lever handles
- . 3-3/8" body
- . Adjustable arms 3" - 8-3/8" centers

Part No#	Chicago Part#	Finish
CHI305RCF	305-RCF	Chrome

Two Handle Wall Mount Adjustable Faucet



- . 2-3/8" lever handles
- . 3-3/8" body
- . Adjustable arms 3" - 8-3/8" centers
- . Includes vacuum breaker with 3/4 MHT connection

Part No#	Chicago Part#	Finish
CHI305VBRCF	305-VBRCF	Chrome

Two Handle Wall Mount With Spout



- . 2-3/8" lever handles
- . .8" body
- . Adjustable arms 7-1/4" - 8-3/4" centers
- . Includes 6" swing spout

Part No#	Chicago Part#	Finish
CHI540LDABCP	540-LDABCP	Chrome

Single Handle Deck Mount Single Hole Faucet



- . 5-1/4" gooseneck spout
- . 2-3/4" lever handle
- . Single hole for a single supply line

Part No#	Chicago Part#	Finish
CHI350ABCP	350-ABCP	Chrome

Two Handle Wall Mount Adjustable Less Spout



- . 2-3/8" lever handles
- . 3-3/8" body
- . Adjustable arms 3" - 8-3/8" centers
- . Spout not included

Part No#	Chicago Part#	Finish
CHI445LESABCP	445-LESABCP	Chrome

Two Handle Wall Mount Adjustable With Spout



- . 2-3/8" lever handles
- . 3-3/8" body
- . Adjustable arms 3" - 8-3/8" centers
- . Includes 6" spout

Part No#	Chicago Part#	Finish
CHI445ABCP	445-ABCP	Chrome

Two Handle Wall Mount Less Spout



- . 2-3/8" lever handles
- . .8" body
- . Adjustable arms 7-1/4" - 8-3/4" centers
- . Spout not included

Part No#	Chicago Part#	Finish
CHI540LD-LESABCP	540-LDLESABCP	Chrome

CHICAGO FAUCETS

Two Handle Deck Mount Less Spout



- . 4" spread
- . 2-3/8 lever handles
- . Spout not included

Part No#	Chicago Part#	Finish
CHI895LESABCP	895-LESAB	Chrome

Chicago Metering Push Button Cartridge



- . Replacement cartridge with push button
- . Chrome finish

Part No#	Chicago Part#	Finish
CHI333XSLOPKABNF	333-XSLOPKAB	Chrome

Chicago Metering Rebuild Kit



- . Kit includes handle, actuator, metering cartridge with filter

Part No#	Chicago Part#	Type
CHI665RKPAB	665-RKPABCP	Rebuild Kit

Chicago Long Stem Compression Cartridge



- . 1/4 turn cartridge
- . Long stem for concealed caps
- . Short stem for exposed caps

Part No#	Chicago Part#	Type
CHI377XTLHBL12JKABNF	377-XTLHBL12JKABNF	Left Hand
CHI377XTRHBL12JKABNF	377-XTRHBL12JKABNF	Right Hand

Chicago Short Stem Compression Cartridge

Part No#	Chicago Part#	Type
CHI1-100XTJKABNF	1-100XTJKABNF	Left Hand
CHI1-099XTJKABNF	1-099XTJKABNF	Right Hand

Chicago Vacuum Breaker



- . Chrome finish
- . Vacuum breaker kit includes cover and screw

Part No#	Chicago Part#	Type
CHI892-254KJKABCP	892-254	Vacuum Breaker
CHI892-302KJKABNF	892-302	V.B Rebuild Kit

Chicago Double-Jointed Swing Spout Extension



- . Polished chrome finish

Part No#	Chicago Part#	Length
CHI686-124KJKABCP	686-124KJKABCP	7"
CHI686-126KJKAB	686-126KJKABCP	11-3/4"

Chicago Standard Spout



- . Chrome finish

Part No#	Chicago Part#	Length
CHIS6JKABCP	S6JKABCP	6"

Chicago Gooseneck Swing Spout



- . Chrome finish
- . Gooseneck spout

Part No#	Chicago Part#	Size
CHIGN1AE3JKABCP	GN1AE3JKABCP	3-1/2"
CHIGN2AE3JKABCP	GN2AE3JKABCP	5-1/4"
CHIGN8AE3JKABCP	GN8AE3JKABCP	8"

Chicago Swing Spout



- . Chrome Finish
- . High Arc swing spout

Part No#	Chicago Part#	Length
CHIL8JKABCP	L8JKABCP	8"
CHIL9JKABCP	L9JKABCP	9-1/2"
CHIL12JKABCP	L12JKABCP	12"
CHIL15JKABCP	L15JKABCP	15"

Chicago Offset Supply Arm



- . 2-1/2" arm

Part No#	Chicago Part#	Finish
CHIHJKABCP	HJKABCP	Chrome

Chicago Replacement Handles



- . Chrome Finish
- . Each set includes a hot and cold replacement handle

Part No#	Chicago Part#	Type
CHI317PRJKCP	317PRJKCP	4" Blade Handle
CHI319PRJKCP	319PRJKCP	6" Blade Handle
CHI369PRJKCP	369PRJKCP	2-3/8" Lever Handle

LOOKING FOR A FAUCET PART NOT LISTED IN THIS CATALOG? GIVE US A CALL! WE MAY STILL HAVE IT!

Chicago Replacement Aerator



- . 2.2 GPM

Part No#	Chicago Part#	Finish
CHIE3JKABCP	E3JKABCP	Chrome

Chicago Aerator To Hose Thread Adapter



- . Aerator to 3/4" male hose thread adapter

Part No#	Chicago Part#	Finish
CHIE2JCRCF	E2-JKRCF	Chrome

Single Hole Deck Mount Pantry Faucet Less Spout



- . 1/2 MPT connection
- . Quarter turn compression cartridge with spring check
- . Faucet spout not included
- . Single temperature control lever handle

Part No#	T & S Part#	Finish
T&SB0205LN	B-0205-LN	Chrome

Single Hole Wall Mount Pantry Faucet Less Spout



- . 1/2 MPT connection with 2" flange
- . Quarter turn compression cartridge with spring check
- . Faucet spout not included
- . Single temperature control 4-arm handle

Part No#	T & S Part#	Finish
T&SB0210LN	B-0210-LN	Chrome

Widespread Wall Mount Pantry Faucet Less Spout



- . 8" spread
- . Adjustable centers from 7-3/4" to 8-1/4"
- . 1/2FPT inlet connections with 2" flanges
- . 1/4 turn lever handles

Part No#	T & S Part#	Finish
T&SB0230LN	B-0230-LN	Chrome

Single Hole Deck Mount Pre-Rinse



- . Easy install riser for fast installation
- . 44" stainless steel hose with handle and ring
- . Includes 6" adjustable wall bracket
- . 1/4 turn lever handles

Part No#	T & S Part#	Finish
T&SB0113B	B-0113-B	Chrome

Widespread Wall Mount Pre-Rinse



- . 8" spread
- . 44" stainless steel hose with handle and ring
- . Adjustable centers from 7-3/4" to 8-1/4"
- . 1/4 turn lever handles

Part No#	T & S Part#	Finish
T&SB0133B	B-0133-B	Chrome

Deck Mount Faucet Less Spout



- . 4" spread
- . 1/2 MPT inlets
- . 1/4 turn lever handles
- . Faucet spout not included

Part No#	T & S Part#	Finish
T&SB1110LN	B-1110-LN	Chrome

Wall Mount Faucet Less Spout



- . 4" spread
- . 1/2 MPT outlets
- . 1/4 turn lever handles
- . Faucet spout not included

Part No#	T & S Part#	Finish
T&SB1115	B-1115-LN	Chrome

Widespread Deck Mount Faucet Less Spout



- . 8" spread
- . 1/2 MPT outlets
- . 1/4 turn lever handles
- . Faucet spout not included

Part No#	T & S Part#	Finish
T&SB1120LN	B-1120-LN	Chrome

Add-On-Faucet Less Spout



- . 3/8 FPT outlet
- . Quarter turn compression cartridge with spring check
- . Allows the option of adding a secondary spout
- . 3" long nipple

Part No#	T & S Part#	Finish
T&SB0155LN	B-0155-LN	Chrome

Single Hole Deck Mount Double Pantry Faucet



- . 1/2 MPT connection
- . Quarter turn compression cartridges with spring checks
- . Faucet spout not included
- . 18" Braided supply lines included

Part No#	T & S Part#	Finish
T&SB0200LN	B-0200-LN	Chrome

Wall Bracket Assembly



- . Chrome plated 6" wall bracket
- . Includes mounting hardware
- . Fits 3/8 pipe

Part No#	T & S Part#	Finish
T&SB010901	B-0109-01	Chrome

Vacuum Breaker Rebuild Kit



- . Repair kit includes brass insert, O-ring and piston
- . Replacement cap sold separately

Part No#	T & S Part#	Type
T&SB0969RK01	B-0969-RK01	V.B Repair Kit
T&SB0969HA	B-0969-HA	Replacement Cap

T & S Swing Spout



- . Swing nozzle for T & S faucets
- . Chrome finish

Part No#	T & S Part#	Length
T&S059X	059X	6"
T&S060X	060X	8"
T&S061X	061X	10"
T&S062X	062X	12"
T&S063X	063X	14"
T&S065X	065X	18"

T & S Double-Jointed Swing Spout



- . Dimension: 12" back section, 6" front section
- . Chrome finish

Part No#	T & S Part#	Length (Overall)
T&S068X	068X	18"

T & S Gooseneck Swing Spout



- . Part# 133X dimensions: 5-11/16" spread, 10-3/8" height, 6-3/8" clearance
- . Part# 132X dimensions: 2-5/8" spread, 9-1/16" height, 5-9/16" clearance

Part No#	T & S Part#	Finish
T&S133X	133X	Chrome
T&S132X	132X	Chrome

Swing Nozzle Garden Hose Adapter



- . Adapts 3/4 male garden hose thread to 55/64-27 female threads

Part No#	T & S Part#	Finish
T&SB-GFE	B-GFE	Chrome

T & S Riser Only



- . 3/8 MPT
- . 18" total length

Part No#	T & S Part#	Finish
T&S00036940	000369-40	Chrome

T & S Pre-Rinse Overhead Spring Only



- . Replacement spring
- . Chrome plated steel

Part No#	T & S Part#	Finish
T&S00088845	000888-45	Chrome

T & S Pre-Rinse Spring Body Only



- . Accepts 3/8 MPT riser

Part No#	T & S Part#	Finish
T&S00082140	000821-40	Chrome

T & S Replacement Spray Hose



- . 44" flexible stainless steel spray hose
- . Includes gray handle

Part No#	T & S Part#	Length
T&SB0044H	B-0044-H	44"

T & S Replacement Spray Nozzle



- . 1.15 GPM
- . Designed for use in industrial kitchens
- . Includes hold down ring
- . Includes gray rubber bumper

Part No#	T & S Part#	Finish
T&SB0107	B-0107	Chrome

Replacement Parts

Part No#	T & S Part#	Item Description
T&S00112145	001121-45	Gray Face Only
T&S0004R	0004R	Finger Hook
T&S00786145	007861-45	Rubber Bumper

T & S B-1100 Series Spindle Stem



. T & S B-1100 Spindle stems

Part No#	T & S Part#	Type
T&S002709-40	002709-40	Cold Stem
T&S002710-40	002710-40	Hot Stem

T & S Eterna Cartridge With Spring Check



. T & S Eterna style cartridge with spring check

Part No#	T & S Part#	Type
T&S00271140	002711-40	Cold Stem
T&S00271240	002712-40	Hot Stem

T & S Add A Faucet Cartridge Less Handle



. Replacement cartridge for T & S Add A Faucet
. Less Handle

Part No#	T & S Part#	Type
T&S00794740	007947-40	Cartridge

T & S Spray Nozzle Cartridge



. T & S spray nozzle cartridge

Part No#	T & S Part#	Type
T&S00285640	002856-40	Cartridge

Ceramic T & S Replacement Cartridge



. Ceramic 1/4 turn cartridges for T & S faucets
. Includes lever handle

Part No#	T & S Part#	Type
T&S01244425	012444-25	Hot Stem
T&S01244525	012445-25	Cold Stem

T & S Replacement Spindles Only



. Replacement T & S spindles

Part No#	T & S Part#	Type
T&SB11K	B-11K	Spindles Only

T & S Replacement Spindle Barrels Only



. Replacement spindles barrels for T & S

Part No#	T & S Part#	Type
T&SB21K	B-21K	Spindle Barrels

T & S B-1100 Faucet Spindle Kit



. Rebuild kit includes spindles & washers

Part No#	T & S Part#	Type
T&SB12K	B-12K	B-1000 Spindle Kit

T & S B-1100 Complete Faucet Rebuild Kit



. Kit includes all stems, washers & O-rings to rebuild

Part No#	T & S Part#	Type
T&SB20K	B-20K	B-1100 Complete

Replacement Handles For T & S



. Replacement handles for T & S faucets
. Chrome finish

Part No#	T & S Part#	Type
T&SBWH-4C	B-WH4C	Cold Blade Handle
T&SBWH-4H	B-WH4H	Hot Blade Handle
T&SB9K	B-9K	Lever Handles (2)

LOOKING FOR A FAUCET PART NOT LISTED IN THIS CATALOG? GIVE US A CALL WE MAY STILL HAVE IT!

BASKET STRAINERS

Junior Bar Sink Strainer



- . Fits standard 2" bar sink drain
- . Includes nuts and washers

Part No#	Size	Finish
J&BBARSINKSTR	2"	Stainless Steel

Junior Bar Sink Strainer With Basket



- . Fits standard 2" bar sink drain
- . Includes removable basket
- . Includes nuts and washers

Part No#	Size	Finish
J&BBARSINKSTRW/BASKE	2"	Stainless Steel

Deluxe Basket Strainer



- . Simple to install
- . Thicker gasket for a better seal
- . Includes nuts and washers

Part No#	Size	Finish
J&BB250BASKETSTR	3-1/2"	Stainless Steel

Deep Cup Style Basket Strainer



- . Deeper cup design allows easier usage of a wrench
- . Includes nuts and washer

Part No#	Size	Finish
J&BDBLCUPBASKETSTR	3-1/2"	Stainless Steel

EZ Twist Basket Strainer



- . Thumb screws tighten for fast and easy installation
- . Triangle design fits most sinks
- . Includes nuts and washers

Part No#	Size	Finish
PASQUICKBASKETSTR	3-1/2"	Stainless Steel

Twist And Lock Basket Strainer



- . Easy to install
- . Includes twist and locking basket
- . Includes nuts and washers

Part No#	Size	Finish
J&BSPIN&LOCKBASKETSTR	3-1/2"	Stainless Steel

Bar Sink Plug



- . Cast brass construction

Part No#	Size	Finish
SIO1BARSINKSTR	2"	Cast Brass

Twist Lever Commercial Drain



- . Chrome plated cast brass twist drain
- . Fits a 3-1/2" sink opening
- . Slip nut and cap for 1-1/4" overflow opening

Part No#	Size	Finish
ZURZ89600	3-1/2"	Chrome

Replacement Parts

Part No#	T & S Part#	Item Description
T&S01038245	010382-45	Rubber Gasket
T&S01038645	010386-45	Flat Strainer
T&S01038945	010389-45	Rubber O-Ring

Overflow Parts For Twist Lever Commercial Drain

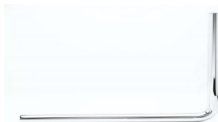

- . Stainless steel overflow tube
- . Brass body overflow head assembly



Part No#	T & S Part#	Finish
BKOVERFLOWTUBE	011355-45	Overflow Tube
BKOVERFLOWELL	011356-45	Overflow Elbow

Commercial Lavatory Grid Drain With Overflow



- . Includes overflow holes and 6" tailpiece
- . Includes rubber mack washer and nuts

Part No#	Size	Finish
J&B11/4CPGRIDDRAIN	1-1/4"	Chrome

Commercial Lavatory Grid Drain Less Overflow



- . Less overflow
- . Includes rubber mack washer and nuts

Part No#	Size	Finish
JONCPVESSELDRAIN	1-1/4"	Chrome

ADA Offset Lavatory Grid Drain



- . Includes overflow holes
- . Twin 90 degree elbows
- . Includes mack washer and nuts

Part No#	Size	Finish
J&B11/4CPOFFSETGRID	1-1/4"	Chrome

Lavatory Pop Up Assembly With Overflow



- . Chrome brass construction
- . Includes all lift rod parts

Part No#	Size	Finish
JONCPPOPUP	1-1/4"	Chrome

Rubber Mack Washer For Pop Up Assembly



- . Universal to fit any standard lavatory pop up or grid drain

Part No#	Size	Type
SCHMACKWASH11/4	1-1/4"	Rubber

Delta Lavatory Pop Up Assembly With Overflow



- . Durable metal construction
- . Backed by Deltas lifetime warranty

Part No#	Delta Part#	Finish
DELRP5651	RP5651	Chrome

Faucet Hole Cover



- . Chrome plated
- . Includes wing nut

Part No#	Size	Type
PASCPFAUCETHOLECOVE	1-5/8"	Chrome

Lavatory Lift Drain Less Overflow



- . For use on any vessel style sink
- . No overflow

Part No#	Size	Finish
JONPOPOPUPDRAINBN	1-1/4"	Stainless Steel

Lavatory Push Up Drain Less Overflow



- . For use on any vessel style sink
- . No overflow

Part No#	Size	Finish
WALPOPUPDRAINCP	1-1/4"	Chrome

Brass Ballcock Nuts



- . Brass ballcock nut for closet
- . Adapts to standard 3/8 plastic or chrome supply line

Part No#	Size	Type
WALBALLCOCKNUTBRASS	5/8" x 7/8"	Brass

Faucet Basin Nut



- . Brass faucet basin nut to be used with any poly supply tube

Part No#	Size	Type
WALBASINNUTBRASS	1/2" FPT	Brass

Braided Stainless Steel Lavatory Supply Line



- . Exceptional flexibility for fast, easy installation
- . Will not kink even in the tightest of spaces
- . Heavy duty brass nickel plated nuts

Part No#	Type	Length
FLUPRO1F12	3/8 FComp x 1/2 FPT	12"
FLUPRO1F16	3/8 FComp x 1/2 FPT	16"
FLUPRO1F20	3/8 FComp x 1/2 FPT	20"
FLUPRO1F30	3/8 FComp x 1/2 FPT	30"

Braided Stainless Steel Closet Supply Line



- . Exceptional flexibility for fast, easy installation
- . Will not kink even in the tightest of spaces
- . Heavy duty brass nickel plated nut

Part No#	Type	Length
FLUPRO3T12	1/2 FComp x 1/2 FPT	12"
FLUPRO1T12	3/8 FComp x 1/2 FPT	12"
FLUPRO1T16	3/8 FComp x 1/2 FPT	16"
FLUPRO1T20	3/8 FComp x 1/2 FPT	20"

Braided Supply Line Extensions



- . Designed to extend any braided stainless steel supply line
- . Exceptional flexibility for fast, easy installation
- . Will not kink even in the tightest of spaces
- . Heavy duty brass nickel plated nut

Part No#	Type	Length
FLUPRO6F12	3/8 FComp x 3/8 FComp	12"
FLUPRO6F20	3/8 FComp x 3/8 FComp	20"
FLUPRO8F12	3/8 FComp x 3/8 MComp	12"
FLUPRO8F20	3/8 FComp x 3/8 MComp	20"

Plastic Closet Supply Tubes



- . For use in potable water and accessible locations only
- . Cut to length for a professional look
- . Pre molded plastic nosepiece connection

Part No#	Type	Length
BRAP1-12DL	3/8 PEX	12"
BRAP1-20DL	3/8 PEX	20"

Plastic Lavatory Supply Tubes



- . For use in potable water and accessible locations only
- . Cut to length for a professional look
- . Pre molded plastic nosepiece connection

Part No#	Type	Length
BRAP1-12A	3/8 PEX	12"
BRAP1-20A	3/8 PEX	20"
BRAP1-30A	3/8 PEX	30"
BRAP1-36A	3/8 PEX	36"

Chrome Lavatory Supply Tubes



- . For use in potable water and accessible locations only
- . Cut to length for a professional look
- . Pre molded chrome nosepiece connection

Part No#	Type	Length
BRA1-12A	3/8 Chrome	12"
BRA1-20A	3/8 Chrome	20"
BRA1-30A	3/8 Chrome	30"

Chrome Closet Supply Tubes



- . For use in potable water and accessible locations only
- . Cut to length for a professional look
- . Pre molded chrome nosepiece connection

Part No#	Size	Length
BRA1-12DL	3/8 Chrome	12"
BRA1-20DL	3/8 Chrome	20"

Chrome Extension Supply Tubes



- . Extension tube for chrome lavatory or closet supply tubes
- . Cut to length for a professional look
- . Includes 3/8 chrome compression nut and brass ferrule

Part No#	Size	Length
BRA1-12KC-C	3/8 Chrome	12"
BRA1-20KC-C	3/8 Chrome	20"

Copper Extension Supply Tubes

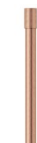

- . Direct sweat copper tube extension

Part No#	Size	Length
BRA1-12KA-R	3/8 Copper	12"

GARBAGE DISPOSALS & PARTS

Insinkerator Badger 1 Disposal



- . Galvanized steel construction
- . Includes quick lock sink mount assembly
- . Wiring kit not included

Part No#	Insinkerator Part#	Horsepower
ISEBAD1	76039H	1/3

Insinkerator Badger 5 Disposal



- . Galvanized steel construction
- . Includes quick lock sink mount assembly
- . Wiring kit not included

Part No#	Insinkerator Part#	Horsepower
ISEBAD5	78578-ISE	1/2

Insinkerator Badger 5XP Disposal



- . Galvanized steel construction
- . Includes quick lock sink mount assembly
- . Wiring kit not included

Part No#	Insinkerator Part#	Horsepower
ISEBAD5XP	75993	3/4

Insinkerator Contractor 333 Disposal



- . Stainless steel grind components
- . Quiet dura drive motor
- . Includes quick lock sink mount assembly
- . Wiring kit not included

Part No#	Insinkerator Part#	Horsepower
ISECON333	75991	3/4

Insinkerator Evolution PRO 750 Disposal



- . Stainless steel grind components
- . Quiet motor and auto reverse
- . Includes quick lock sink mount assembly
- . Wiring kit not included

Part No#	Insinkerator Part#	Horsepower
ISEPRO750	77609	3/4

Insinkerator Evolution PRO 1100 Disposal



- . Stainless steel body and grind components
- . Most power and quiet disposal
- . Includes quick lock sink mount strainer
- . Wiring kit not included

Part No#	Insinkerator Part#	Horsepower
ISEPRO1100XL	77612	1.1

Insinkerator PRO 800LT Disposal



- . Compact design
- . Includes quick lock sink mount assembly
- . Wiring kit not included

Part No#	Insinkerator Part#	Horsepower
ISEPRO800LT	77610	7/8

Insinkerator PRO Cover Control Plus Disposal



- . Cover Control on/off
- . Includes quick lock sink mount assembly
- . Wiring kit not included

Part No#	Insinkerator Part#	Horsepower
ISEPROCC	77089	7/8

Air Top Switch Satin Nickel



- . Disposal switch kit with satin nickel button

Part No#	Insinkerator Part#	Finish
ISESTS00SN	STS-00SN	Satin Nickel

Garbage Disposal Mounting Flange



- . Replacement mounting flange for any Insinkerator disposal
- . Fits most stainless steel sinks
- . Easy installation

Part No#	Insinkerator Part#	Type
ISEQLM-00	72376D	Steel

Garbage Disposal Standard Mounting Gasket



- . Replacement mounting gasket for any insinkerator disposal

Part No#	Insinkerator Part#	Type
ISESMG-00	09963D	Rubber

Garbage Disposal Deluxe Mounting Gasket



- . Replacement mounting gasket for any insinkerator disposal
- . Deeper design

Part No#	Insinkerator Part#	Type
ISEDGMG-00	09959D	Rubber

GARBAGE DISPOSAL PARTS

Garbage Disposal Quiet Baffle Collar



- . Replacement quiet baffle collar for Insinkerator Evolution quiet series disposals
- . Helps reduce disposer noise
- . Prevents food and water from splashing back out of disposal

Part No#	Insinkerator Part#	Type
ISEQCB-AM	74653D	Rubber

Garbage Disposal Jam Buster Wrench



- . Helps free jams in any Insinkerator disposal
- . Insert the hex key into the center hole into the bottom of the disposal to free the jam

Part No#	Insinkerator Part#	Type
ISEWRN-00	08305D	Tool

Garbage Disposal Plastic Cover Cap



- . Plastic cap to cover disposal side of a sink drain

Part No#	Insinkerator Part#	Type
ISESTPPL	STP-PL	Plastic

Garbage Disposal Wiring Kit



- . Kit includes 3 wire nuts and connector
- . 16/3 wire gauge

Part No#	Type	Sell Qty
PASPIGTAILKIT	Disposal Wiring Kit	Each

Wire Nuts



- . Sold individually

Part No#	Size	Color
EMCWIRENUTORANGE	Orange	12-18
EMCWIRENUTYELLOW	Yellow	14-22

Electrical Tape



- . General purpose electrical tape
- . 7 mil Vinyl material

Part No#	Size	Color
EMCBLKELECTRICALTAPE	3/4" x 66ft	Black

Rubber Garbage Disposal Adapter



- . Includes two stainless steel hose clamps

Part No#	Description	Type
PASRUBBERDISPADPT	Rubber Disposal Adapter	Rubber

Rubber Dishwasher Discharge Hose



- . EPDM tubes with reinforced double-ply spiraled polyester
- . Burst pressure at 280 PSI
- . Sell by the foot

Part No#	Size	Sell Qty
HAR5/8RUBBERHOSE	5/8" ID	FT
HAR7/8RUBBERHOSE	7/8" ID	FT

Stainless Steel Hose Clamps



- . Stainless steel hose clamps with 5/16 nut driver head
- . 1/2 diameter bands
- . #12 hose clamp is most common for dishwashers

Part No#	Size	Sell Qty
EMCHOSECLAMP4	7/32"-5/8"	Each
EMCHOSECLAMP6	3/8"-7/8"	Each
EMCHOSECLAMP10	7/16"-1"	Each
EMCHOSECLAMP12	9/16"-1-1/4"	Each
EMCHOSECLAMP16	11/16"-1-1/2"	Each
EMCHOSECLAMP20	3/4"-1-3/4"	Each
EMCHOSECLAMP24	1-1/16"-2"	Each
EMCHOSECLAMP36	1-13/16"-2-3/4"	Each

Insinkerator H-Wave Instahot With Tank



- . Includes hot water dispenser and 2/3-gallon tank
- . Hot water tank dispenses up to 60 cups per hour
- . Thermostat adjustable from 160°F to 210°F

Part No#	Insinkerator Part#	Finish
ISEHWAVEC	44714	Chrome
ISEHWAVESN	44714A	Satin Nickel

Insinkerator HOT100 Instahot With Tank



- . Includes hot water dispenser and 2/3-gallon tank
- . Hot water tank dispenses up to 60 cups per hour
- . Thermostat adjustable from 160°F to 210°F
- . Easy push button activation

Part No#	Insinkerator Part#	Finish
ISEHOT100C	44887	Chrome
ISEHOT100SN	44887B	Satin Nickel

Insinkerator Instahot Tank And Filter Only



- . 2/3-gallon tank and replacement filter
- . Hot water tank dispenses up to 60 cups per hour
- . Thermostat adjustable from 160°F to 210°F

Part No#	Insinkerator Part#	Type
ISEHWTF1000S	44723	Replacement Part

HWT-00 Tank Only



- . 2/3-gallon tank
- . Hot water tank dispenses up to 60 cups per hour
- . Thermostat adjustable from 160°F to 210°F

Part No#	Insinkerator Part#	Type
ISEHWT-00	44875	Replacement Part

Insinkerator Hot And Cold Faucet Only



- . Dispenses both steaming hot and cold water
- . Swivel high arc style spout
- . Durable all brass construction
- . Instahot tank sold separately

Part No#	Insinkerator Part#	Finish
ISEF-HC1100C	44252	Chrome
ISEF-HC1100SN	44252B	Satin Nickel

Insinkerator Instahot Faucet Only



- . Dispenses hot steaming water only
- . Swivel high arc style spout
- . Durable all brass construction
- . Instahot tank sold separately

Part No#	Insinkerator Part#	Finish
ISEF-GN1100C	44251	Chrome
ISEF-GN1100SN	44251B	Satin Nickel

Filter For Insinkerator Instahot Tank



- . Replacement filter for newer Insinkerator Instahots
- . Includes 1 filter in pack

Part No#	Insinkerator Part#	Type
ISEF-1000	44678	Replacement Part

Filters For Insinkerator Water Systems



- . Replacement filter for older Insinkerator water systems
- . Includes 2 filters in pack

Part No#	Insinkerator Part#	Type
ISEF201R	44634	Replacement Part

SUPPLY VALVES

Sweat Supply Valves



Part No#	Size	Type	Brand	Handle	Finish
BRAR09XR	1/2 SWT x 1/4 Comp	Angle	Brasscraft	Multi Turn	Rough Brass
BRAR14XC	1/2 SWT x 3/8 Comp	Straight	Brasscraft	Multi Turn	Chrome
BRAR19XC	1/2 SWT x 3/8 Comp	Angle	Brasscraft	Multi Turn	Chrome
LEG1/2X3/8SWTANGLEST	1/2 SWT x 3/8 Comp	Straight	Legend	1/4 Turn	Chrome
LEG1/2X3/8SWTSTRSTOP	1/2 SWT x 3/8 Comp	Angle	Legend	1/4 Turn	Chrome

Compression Supply Valves



Part No#	Size	Type	Brand	Handle	Finish
LEG1/4X1/4COMPSTRSTOP	1/4 Comp x 1/4 Comp	Straight	Legend	Multi Turn	Chrome
LEG3/4X3/8COMPSTRSTOP	3/8 Comp x 3/8 Comp	Straight	Legend	Multi Turn	Chrome
BRACR04C	5/8 OD x 1/4 Comp	Straight	Legend	1/4 Turn	Chrome
LEG1/2X1/4COMPANGLES	5/8 OD x 1/4 Comp	Angle	Legend	1/4 Turn	Chrome
BRACR09XC	5/8 OD x 1/4 Comp	Angle	Brasscraft	Multi Turn	Rough Brass
BRACR14XC	5/8 OD x 3/8 Comp	Straight	Brasscraft	1/4 Turn	Chrome
LEG1/2X3/8COMPSTRSTO	5/8 OD x 3/8 Comp	Straight	Legend	1/4 Turn	Chrome
BRACR19XC	5/8 OD x 3/8 Comp	Angle	Brasscraft	1/4 Turn	Chrome
LEG1/2X3/8COMPANGLES	5/8 OD x 3/8 Comp	Angle	Legend	1/4 Turn	Chrome

PEX Supply Valves



Part No#	Size	Type	Brand	Handle	Finish
BRAPEX09C	1/2 PEX x 1/4 Comp	Angle	Brasscraft	1/4 Turn	Chrome
LEG1/2x1/4PEXANGLEST	1/2 PEX x 1/4 Comp	Angle	Legend	1/4 Turn	Chrome
BRAPEX14C	1/2 PEX x 3/8 Comp	Straight	Brasscraft	1/4 Turn	Chrome
LEG1/2x3/8PEXSTRSTOP	1/2 PEX x 3/8 Comp	Straight	Legend	1/4 Turn	Chrome
BRAPEX19C	1/2 PEX x 3/8 Comp	Angle	Brasscraft	1/4 Turn	Chrome
LEG1/2X3/8PEXANGLEST	1/2 PEX x 3/8 Comp	Angle	Legend	1/4 Turn	Chrome

Push Supply Valves



Part No#	Size	Type	Brand	Handle	Finish
LEG1/2X3/8SBSTRSTOP	1/2 Push x 3/8 Comp	Straight	Legend	1/4 Turn	Chrome
LEG1/2X3/8SBANGLEST	1/2 Push x 3/8 Comp	Angle	Legend	1/4 Turn	Chrome

Threaded Supply Valves



Part No#	Size	Type	Brand	Handle	Finish
BRAR10XC	3/8 FPT x 3/8 Comp	Straight	Legend	1/4 Turn	Chrome
BRAR15XC	3/8 FPT x 3/8 Comp	Angle	Legend	1/4 Turn	Chrome
BRAR12XC	1/2 FPT x 3/8 Comp	Straight	Legend	1/4 Turn	Chrome
BRAR17XC	1/2 FPT x 3/8 Comp	Angle	Legend	1/4 Turn	Chrome
BRAR32C	1/2 FPT x 1/2 OD Comp	Straight	Brasscraft	Multi Turn	Chrome
BRAR37C	1/2 FPT x 1/2 OD Comp	Angle	Brasscraft	Multi Turn	Chrome

SUPPLY VALVES



CPVC Supply Valves

Part No#	Size	Type	Brand	Handle	Finish
LEG1/2X3/8CPVCSTRSTO	1/2 CPVC x 3/8 Comp	Straight	Legend	1/4 Turn	Chrome
LEG1/2X3/8CPVCANGLES	1/2 CPVC x 3/8 Comp	Angle	Legend	1/4 Turn	Chrome



Copper Press Supply Valves

Part No#	Size	Type	Brand	Handle	Finish
LEG1/2X3/8PRESSANGLE	1/2 Press x 3/8 Comp	Angle	Legend	1/4 Turn	Chrome
LEG1/2X3/8PRESSSTRST	1/2 Press x 3/8 Comp	Straight	Legend	1/4 Turn	Chrome
LEG1/2X1/4PRESSANGLE	1/2 Press x 1/4 Comp	Angle	Legend	1/4 Turn	Chrome



Loose Key Supply Valves

Part No#	Size	Type	Brand	Handle	Finish
BRASR14XC	1/2 SWT x 3/8 Comp	Straight	Brasscraft	None	Chrome
BRASR19XC	1/2 SWT x 3/8 Comp	Angle	Brasscraft	None	Chrome
BRASR15XC	3/8 FPT x 3/8 Comp	Angle	Brasscraft	None	Chrome
BRASR17XC	1/2 FPT x 3/8 Comp	Angle	Brasscraft	None	Chrome



Dual Supply Valves

Part No#	Size	Type	Brand	Handle	Finish
BRAR1901LR	1/2 SWT x 3/8 Comp	Straight/ Angle	Brasscraft	Multi Turn	Rough Brass
BRACR1901LR	5/8 OD x 3/8 Comp	Straight/ Angle	Brasscraft	Multi Turn	Rough Brass

Supply Valve Add A Line



. Adapts to a 3/8 male compression thread to allow the addition of another supply tube

. Compression nuts and ferrules not included

Part No#	Size	Finish
BRAC2-666XP	3/8 FComp x 3/8 MComp x 3/8 MComp	Rough Brass
BRAC2-664XP	3/8 FComp x 3/8 MComp x 1/4 MComp	Rough Brass

Washers For Multi Turn Supply Valves



. Replacement bibb washer and bonnet packing for multi turn supply valves

Part No#	Description	Type
R15-5	Bibb Washer	Rubber
R15-78F	Bonnet Packing	Rubber

Replacement Handle For Multi Turn Supply Valves



. Chrome oval supply valve handle

Part No#	Description	Finish
R15-10T-C	Chrome Handle Only	Chrome

Replacement Ends For Chrome Supply Tube



. Replacement tops for chrome supply tubes

Part No#	Size	Type
BRA1DL	3/8	Closet
BRA1ANOSEPC	3/8	Lavatory

Madison Heights Plumbing & Heating Supply

SECTION 3 - TUB & SHOWER

Shower Units	48
Tub & Shower Valve Kits	49-57
Bathtub Waste Kits	58-59
Roman Tub & Moen Parts	60
Laundry Tubs.....	61-62

Mustee Fiberglass Shower Stall Base Only



- . Sturdy fiberglass construction
- . Semi-gloss mold and mildew resistant surface
- . Molded drain designed for 2" DWV
- . Can be used with shower wall unit or ceramic tile

Part No#	Size	Color
MUS3232MWHTBASE	32" x 32"	White
MUS3232MBNBASE	32" x 32"	Bone
MUS3248MWHTBASE	32" x 48"	White
MUS3260MWHTBASE	32" x 60"	White
MUS3448MWHTBASE	34" x 48"	White
MUS3448MBNBASE	34" x 48"	Bone
MUS3636MWHTBASE	36" x 36"	White
MUS3636MBNBASE	36" x 36"	Bone

Mustee Fiberglass Neo Angle Base Only



- . Sturdy fiberglass construction
- . Semi-gloss mold and mildew resistant surface
- . Molded drain designed for 2" DWV
- . Designed for a corner shower

Part No#	Size	Color
MUS3636CMWHTNEOBAS	36" x 36"	White
MUS3838CMWHTNEOBAS	38" x 38"	White
MUS3838CMBNNEOBASE	38" x 38"	Bone

Mustee Bathtub To Shower Stall Conversion Base



- . Converts a standard 30" x 60" tub to a fiberglass shower stall
- . Sturdy fiberglass construction
- . Molded drain designed for 2" DWV
- . Semi-gloss mold and mildew resistant surface

Part No#	Size	Color
MUS3060LWHT	30" x 60" Left Hand Drain	White
MUS3060RWHT	30" x 60" Right Hand Drain	White

Mustee Bathtub To Shower Stall Drain Kit



- . For use on Mustee 3060 right or left hand shower bases
- . Adapts to an 1-1/2" drain pipe

Part No#	Size	Type
MUSDRAINCONVKIT	1-1/2" DWV	Plastic

Mustee DURASTALL Shower Stall Unit



- . Free standing shower unit complete in one box
- . Slip resistant floor with drain
- . Mold and mildew resistant components
- . Shower door is not included

Part No#	Size	Color
MUS80SHOWER	32" x 32"	White
MUS140SHOWER	36" x 36"	White

Mustee DURAWALL Corner Shower Stall Unit



- . To be used with Mustee Neo Angle bases
- . Molded fiberglass construction
- . Smooth semi-gloss finish
- . Ideal for a tight space bathroom

Part No#	Size	Color
MUS736CW	36" x 36"	White
MUS738CWHT	38" x 38"	White

Mustee DURAWALL Shower Stall Unit



- . To be used with Mustee shower stall base
- . Molded fiberglass construction
- . Smooth semi-gloss finish
- . Includes 3 large shelves

Part No#	Size	Color
MUS732WHT	32" x 32"	White
MUS732BN	32" x 32"	Bone
MUS736WHT	36" x 36"	White
MUS736BN	36" x 36"	Bone
MUS748-32WHT	32" x 48"	White
MUS748-34WHT	34" x 48"	White
MUS748-34BN	34" x 48"	Bone

Mustee TOPAZ Premium Tub Wall



- . Fits standard 30" x 60" bathtub alcove
- . Fiberglass construction
- . WALL KIT ONLY, BATHTUB SOLD SEPERATLY

Part No#	Size	Color
MUS660TWHHTUBWALLKI	30" X 60"	White

MULTI HANDLE TUB & SHOWER VALVES

Gerber Two Handle 8" FPT Tub & Shower Valve



- . Includes compression cartridges
- . Includes diverter tub spout and single function showerhead
- . FPT connections

Part No#	Gerber Part#	Type
GER48720	07-48-720	FPT

Gerber Two Handle 8" FPT Shower Only Valve



- . Includes compression cartridges
- . Includes diverter tub spout and single function showerhead
- . FPT connections

Part No#	Gerber Part#	Type
GER48220	07-48-220	FPT

Gerber Three Handle 8" Tub & Shower Valve



- . Includes compression cartridges
- . Includes filler tub spout and single function showerhead
- . Designed to fit an 8" handle spread

Part No#	Gerber Part#	Type
GER48031	07-48-031	Sweat
GER48030	07-48-030	FPT

Three Handle 11" Tub & Shower Valve



- . Includes compression cartridges
- . Includes filler tub spout and single function showerhead
- . Designed to fit an 11" handle spread

Part No#	Gerber Part#	Type
GER47130	07-47-130-83	FPT

Three Handle 8" Ceramic T & S Valve



- . Includes ceramic disc cartridges for 1/4 turn handles
- . Includes filter tub spout and single function showerhead
- . Designed to fit an 8" handle spread

Part No#	Gerber Part#	Type
GER58510	58-510	Sweat
GER58500	58-500	FPT

Chrome Plated Shower Arm



- . Universal chrome plated shower arm
- . 1/2 MPT

Part No#	Size	Type
PASCPSHOWERARM	1/2	MPT

Gerber Tub & Shower Rebuild Kit



- . GBK01 long broach, GBK02 short broach
- . Rebuild kit includes all stems, handles, escutcheons, sleeves, and faucet seats
- . Universal fit for Gerber

Part No#	Walrich Part#	Size
WALGBK01	GBK01	11"
WALGBK02	GBK02	8"

Price Pfister Tub & Shower Rebuild Kit



- . Rebuild kit includes all stems, handles, escutcheons, sleeves and faucet seats
- . Universal fit for Price Pfister

Part No#	Walrich Part#	Size
WALPPK01	PPK01	8"

Gerber Ceramic Tub And Shower Stems



- . Replacement cartridges for Gerber ceramic tub and shower kits
- . Brass construction
- . 1/4 turn

Part No#	Gerber Part#	Part
GER98-705	98-705	Ceramic Stem - Cold
GER98-709	98-709	Ceramic Stem - Hot

Gerber Tub And Shower Replacement Handles



- . Replacement handles for Gerber tub and shower kits
- . Use Gerber #94-402 long broach for 11" kits
- . Use Gerber #94-401 short broach for 8" kits

Part No#	Gerber Part#	Type
GER94-401	94-401	Short Broach
GER94-402	94-402	Long broach



- . Replacement handles for Gerber ceramic tub and shower kits
- . 1/4 turn

Part No#	Gerber Part#	Type
GER97-740	97-940	Ceramic Handle

MULTI HANDLE TUB & SHOWER VALVE PARTS

Gerber Escutcheon Nipple



. Replacement escutcheon nipple for Gerber tub and shower kits
 . 5/8 diameter

Part No#	Gerber Part#	Description
GER90-067	90-067	5/8 Nipple

Gerber Brass Nut Only



. Replacement brass nut for Gerber tub and shower kits

Part No#	Gerber Part#	Description
GER96-690	96-690	Brass Nut

Gerber Combination IPS/Solder Adapter



. Replacement adapter for Gerber tub and shower kits

Part No#	Gerber Part#	Description
GER90-173	90-173	IPS/Solder Adapter

Gerber Brass Faucet Seat



. Replacement brass seat for both Gerber faucets and tub and shower kits

Part No#	Gerber Part#	Description
GER90-161	90-161	Brass Seat

Gerber Handle Escutcheon



. Replacement handle escutcheon and sleeve for Gerber tub and shower kits

Part No#	Gerber Part#	Description
GER90-268	90-268	Escutcheon Tube

Gerber Threaded Sleeve Only



. Replacement Gerber threaded sleeve tube only

Part No#	Gerber Part#	Description
GER90-021	90-021	Threaded Sleeve

LOOKING FOR A TUB & SHOWER PART NOT LISTED IN THIS CATALOG? GIVE US A CALL WE MAY STILL HAVE IT!

DELTA ROUGH & TRANSFER VALVES

Delta Rough Valve



- . Rough valve for Delta Monitor style trim kits
- . Available in several different connection styles

Part No#	Delta Part#	Type
DELR10000UNBX	R10000UNBX	Sweat
DELR10000UNWS	R10000UNWS	Sweat With Valves
DELR10000UNBXHF	R10000UNBXHF	Sweat--Shower Only
DELR10000IP	R10000IP	FPT
DELR10000PX	R10000PX	PEX
DELR10000PXWS	R10000PXWS	PEX With Valves

Replacement Bonnet Nut For Delta Rough Valve



- . Replacement bonnet nut for Delta tub and shower rough valves

Part No#	Delta Part#	Type
DELRP22734	RP22734	Bonnet Nut

Delta Integrated Rough/Transfer Valve



- . Combination shower only rough and transfer valve
- . Trim kits must be special ordered

Part No#	Delta Part#	Type
DELR22000	R22000	Sweat

Delta Transfer Rough Valve 3 & 6 Function



- . Rough valve for Delta transfer trim kits
- . Will work with both 3 and 6 function kits

Part No#	Delta Part#	Type
DELR11000	R11000	Sweat

Extension Kit For Delta R11000 Transfer Valve



- . Extension kit for Delta R11000 transfer valve

Part No#	Delta Part#	Type
DELRP75137	RP75137	Extension Kit

Delta Transfer Valve Trim Kit



- . Trim kit for Delta R11000 transfer valve

Part No#	Delta Part#	Finish	Function
DELT11800	T11800	Chrome	3
DELT11800SS	T11800-SS	Stainless Steel	3
DELT11900	T11900	Chrome	6
DELT11900SS	T11900-SS	Stainless Steel	6

DELTA SINGLE HANDLE STANDARD TRIM KITS & PARTS

Delta Classic Monitor 13 Shower Only



- . Trim only, must order Delta rough valve separately
- . Includes Water Sense shower head which uses 20% less water than most shower heads
- . Pressure balanced cartridge to control hot and cold water

Part No#	Delta Part#	Finish
DELT13220	T13220	Chrome
DELT13220SS	T13220-SS	Stainless Steel

Delta Classic Monitor 13 Tub & Shower



- . Trim only, must order Delta rough valve separately
- . Includes Water Sense shower head which uses 20% less water than most shower heads
- . Pressure balanced cartridge to control hot and cold water
- . Includes pull down style diverter tub spout

Part No#	Delta Part#	Finish
DELT13420	T13420-PD	Chrome
DELT13420SS	T13420-SSPD	Stainless Steel

Delta Replacement Cartridges for 1300 Trim Kits



- . Delta #RP19804 - Replacement cartridge for Delta 1300 or 1400 trim kits 2006 and prior
- . Delta #RP46074 - Replacement cartridge for Delta 1300 or 1400 trim kits after 2006
- . Both cartridges are pressure balanced

Part No#	Delta Part#	Type
DELRP19804	RP19804	Old Cartridge
DELRP46074	RP46074	New Cartridge

Delta Shower Renovation Cover Plate

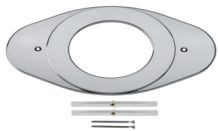

- . Converts a three handle tub and shower valve to a single handle tub and shower valve
- . Covers up to 8" center holes

Part No#	Delta Part#	Finish
DELRP29827	RP29827	Chrome
DELRP29827SS	RP29827SS	Stainless Steel

Delta 1300 Trim Kit Parts

Part No#	Delta Part#	Item Description
DELRP48717	RP48717	Lever Handle
DELRP196	RP196	CP Trim Screw
DELRP196SS	RP196SS	SS Trim Screw
DELRP12630	RP12630	CP Long Trim Screw
DELRP17453	RP17453	Diverter Spout-IPS
DELRP5836	RP5836	Diverter Spout-Slip
DELRP22735	RP22735	Trim Sleeve

Delta Classic Monitor 17 Shower Only



- . Trim only, must order Delta rough valve separately
- . Includes two handle design to control both temperature and water volume separately
- . Pressure balanced cartridge to control hot and cold water

Part No#	Delta Part#	Finish
DELT17230	T17230	Chrome

Delta Classic Monitor 17 Tub & Shower



- . Trim only, must order Delta rough valve separately
- . Includes two handle design to control both temperature and water volume separately
- . Pressure balanced cartridge to control hot and cold water
- . Includes pull down style diverter tub spout

Part No#	Delta Part#	Finish
DELT17430	T17430-PD	Chrome

Delta Replacement Cartridges for 1700 Trim Kits



- . Delta #RP32104 - Replacement cartridge for Delta 1700 trim kits 2006 and prior
- . Delta #RP46463 - Replacement cartridge for Delta 1700 trim kits after 2006
- . Both cartridges are pressure balanced

Part No#	Delta Part#	Type
DELRP32104	RP32104	Old Cartridge
DELRP46463	RP46463	New Cartridge

Delta 1700 Trim Kit Parts

Part No#	Delta Part#	Item Description
DELRP37731	RP37731	Trim Sleeve
DELRP25620	RP25620	Set Screw

Delta Woodhurst Monitor 14 Shower Only



- . Trim only, must order Delta rough valve separately
- . Pressure balanced cartridge to control hot and cold water
- . Includes pull up style diverter tub spout

Part No#	Delta Part#	Finish
DELT14232	T14232	Chrome
DELT14232SS	T14232-SS	Stainless Steel
DELT14232RB	T14232-RB	Oil Rubbed Bronze

Delta Woodhurst Monitor 14 Tub & Shower



- . Trim only, must order Delta rough valve separately
- . Pressure balanced cartridge to control hot and cold water
- . Includes pull up style diverter tub spout

Part No#	Delta Part#	Finish
DELT14432	T14432	Chrome
DELT14432SS	T14432-SS	Stainless Steel
DELT14432RB	T14432-RB	Oil Rubbed Bronze

Delta Lahara Monitor 14 Shower Only



- . Trim only, must order Delta rough valve separately
- . Pressure balanced cartridge to control hot and cold water

Part No#	Delta Part#	Finish
DELT14238	T14238	Chrome
DELT14238SS	T14238-SS	Stainless Steel

Delta Lahara Monitor 14 Tub & Shower



- . Trim only, must order Delta rough valve separately
- . Pressure balanced cartridge to control hot and cold water
- . Includes pull up style diverter tub spout

Part No#	Delta Part#	Finish
DELT14438	T14438	Chrome
DELT14438SS	T14438-SS	Stainless Steel

Delta Dryden Monitor 14 Shower Only



- . Trim only, must order Delta rough valve separately
- . Pressure balanced cartridge to control hot and cold water

Part No#	Delta Part#	Finish
DELT14251	T14251	Chrome
DELT14251SS	T14251-SS	Stainless Steel

Delta Dryden Monitor 14 Tub & Shower



- . Trim only, must order Delta rough valve separately
- . Pressure balanced cartridge to control hot and cold water
- . Includes pull up style diverter tub spout

Part No#	Delta Part#	Finish
DELT14451	T14451	Chrome
DELT14451SS	T14451-SS	Stainless Steel

Delta Lahara Monitor 17 Shower Only



- . Trim only, must order Delta rough valve separately
- . Includes two handle design to control both temperature and water volume separately

Part No#	Delta Part#	Finish
DELT17238	T17238	Chrome
DELT17238SS	T17238-SS	Stainless Steel

Delta Lahara Monitor 17 Tub & Shower



- . Trim only, must order Delta rough valve separately
- . Includes two handle design to control both temperature and water volume separately
- . Pressure balanced cartridge to control hot and cold water
- . Includes pull up style diverter tub spout

Part No#	Delta Part#	Finish
DELT17438	T17438	Chrome
DELT17438SS	T17438-SS	Stainless Steel

Delta Dryden Monitor 17 Shower Only



- . Trim only, must order Delta rough valve separately
- . Includes two handle design to control both temperature and water volume separately
- . Pressure balanced cartridge to control hot and cold water

Part No#	Delta Part#	Finish
DELT17251	T17251	Chrome
DELT17251SS	T17251-SS	Stainless Steel

Delta Dryden Monitor 17 Tub & Shower



- . Trim only, must order Delta rough valve separately
- . Includes two handle design to control both temperature and water volume separately
- . Includes pull up style diverter tub spout

Part No#	Delta Part#	Finish
DELT17451	T17451	Chrome
DELT17451SS	T17451-SS	Stainless Steel

DELTA SINGLE HANDLE TRIM KIT PARTS

Delta 1600 Series Replacement Cartridge



- . Replacement cartridge for Delta 1600 series trim kits
- . Includes rubber seats
- . **WILL NOT WORK IN MONITOR STYLE TRIMS**

Part No#	Delta Part#	Type
DELRP1991	RP1991	Cartridge

Delta Tub & Shower Push Button Diverter



- . Diverts water from tub spout to shower head

Part No#	Delta Part#	Type
DELRP5649	RP5649	Diverter Stem

Delta Kitchen Diverter Stem



- . Diverter stem for Delta kitchen faucets

Part No#	Delta Part#	Type
DELRP63135	RP63135	Diverter Stem

Delta Kitchen Diverter Stem



- . Diverter stem for Delta kitchen faucets

Part No#	Delta Part#	Type
DELRP63136	RP63136	Diverter Stem

Delta Three Handle Tub & Shower Diverter Stem



- . Diverter stem for Delta three handle tub and shower faucets

Part No#	Delta Part#	Type
DELRP10799	RP10799	Diverter Stem

Delta Three Handle Tub & Shower Diverter Stem



- . Diverter stem for Delta three handle tub and shower faucets produced before 1990

Part No#	Delta Part#	Type
DELRP17730	RP17730	Diverter Stem

Delta Limit Stop



- . Limit stop for Delta monitor style cartridge

Part No#	Delta Part#	Type
DELRP19807	RP19807	Limit Stop

LOOKING FOR A TUB & SHOWER PART NOT LISTED IN THIS CATALOG? GIVE US A CALL WE MAY STILL HAVE IT!

TUB & SHOWER PARTS

Universal Filler Tub Spout



- . Die cast chrome finish
- . 1/2 FPT front mount

Part No#	Size	Type
PASTUBFILLERSPOUT	1/2 FPT	Filler Tub Spout

Tub Filler Spout For Delta



- . Chrome finish
- . 1/2 FPT connection
- . Also fits Peerless prior to 2004

Part No#	Delta Part#	Type
DELRP5833	RP5833	Filler Tub Spout

Universal Pull Up Diverter Tub Spout



- . Die cast chrome finish
- . 1/2 FPT front mount
- . Pull up style diverter

Part No#	Size	Type
PASDIVERTERSPOUT	1/2" FPT	Diverter Spout

Pull Down Diverter Tub Spout For Delta



- . Heavy duty construction
- . Chrome finish
- . Available in both 1/2 FPT & slip on connections

Part No#	Delta Part#	Connection
DELRP17453	RP17453	1/2" FPT
DELRP5836	RP5836	1/2" Slip On

Universal Die Cast Shower Head



- . 2" die cast zinc shower head
- . 2.5 GPM

Part No#	Description	Finish
WALCPSHOWERHEAD	2" Die Cast Shower Head	Chrome

Delta Fundamentals Single Setting Shower Head



- . 2-5/8 Spray face
- . Full body spray setting

Part No#	Delta Part#	Finish
DELRP38357	RP38357	Chrome

SPECIALTY SHOWER

Delta In2ition 5-Setting Two-In-One Shower



- . Includes 5 different spray settings
- . Includes water pause feature
- . Includes 82" spray hose
- . Easy clean

Part No#	Delta Part#	Finish
DEL58569PK	58569-PK	Chrome
DEL58569SSPK	58569-SS-PK	Stainless Steel

Delta Premium 5-Setting Hand Shower



- . Includes 5 different spray settings
- . Easy clean

Part No#	Delta Part#	Finish
DEL59436PK	59436-PK	Chrome
DEL59436SSPK	59436-SS-PK	Stainless Steel

Delta Fundamentals 2-Setting Hand Shower



- . Full body spray hand shower
- . Includes water pause feature

Part No#	Delta Part#	Finish
DEL59462BPK	59462-B-PK	Chrome

Delta Fundamentals 4-Setting Hand Shower



- . Includes 4 different spray settings

Part No#	Delta Part#	Finish
DEL59465PK	59465-PK	Chrome

Delta ActivTouch 9-Setting Hand Shower



- . Includes 9 different spray settings
- . Includes water pause feature

Part No#	Delta Part#	Finish
DEL59424PK	59424-PK	Chrome

Delta Premium 3-Setting Slide Bar Hand Shower



- . Includes 3 different spray settings
- . Includes 70" spray hose
- . Includes adjustable wall bar

Part No#	Delta Part#	Finish
DEL57014	57014	Chrome
DEL57014SS	57014-SS	Stainless Steel

Delta Premium 5-Setting Fixed Hand Shower



- . Includes 5 different spray settings
- . Includes 60" spray hose
- . Easy clean

Part No#	Delta Part#	Finish
DEL55436PK	55436-PK	Chrome
DEL55436SSPK	55436-SS-PK	Stainless Steel

Delta Wall Elbow For Hand Shower



- . Personal shower wall supply elbow

Part No#	Delta Part#	Finish
DEL50560	50560	Chrome
DEL50560SS	50560-SS	Stainless Steel

Delta Stretchable Hand Shower Hose



- . Stretchable hose from 60" - 82"
- . Replacement rubber hose gasket

Part No#	Delta Part#	Finish
DELU495D60PK	U495D-60-PK	Chrome
DELU495DSS60PK	U495S-SS60-PK	Stainless Steel
DELU4959PAKBG	4959PAKBG	Hose Gasket Only

Delta Adjustable Hand Shower Arm Mount



- . Mounts hand shower to shower arm
- . 1/2" FPT x 1/2" MPT connection

Part No#	Delta Part#	Finish
DELU3401PK	U3401-PK	Chrome
DELU3401SSPK	U3401-SS-PK	Stainless Steel

SPECIALTY SHOWER

Delta Pin Wall Mount For Hand Shower



. For use with pin mount screw connectors

Part No#	Delta Part#	Finish
DELU5001PK	U5001-PK	Chrome

Delta Hand Shower Pin Mount Swivel Connector



. Swivel connector for hand shower
. For use with pin wall mount

Part No#	Delta Part#	Finish
DELU5002PK	U5002-PK	Chrome

Delta Hand Shower Pin Mount Swivel Connector



. Swivel connector for hand shower
. 1/2" FPT x 1/2" MPT connection

Part No#	Delta Part#	Finish
DELU4002PK	U4002-PK	Chrome

Delta Shower Arm Diverter For Hand Shower



. Shower arm diverter valve

Part No#	Delta Part#	Finish
DELU4922PK	U4922-PK	Chrome

Delta 3-Way Shower Arm Diverter



. Diverts water between hand shower and shower head

Part No#	Delta Part#	Finish
DELU4923PK	U4923-PK	Chrome
DELU4923SSPK	U4923-SS-PK	Stainless Steel

Delta 3-Way Shower Arm Diverter



. Diverts water from hand shower to shower head
. ADA complaint lever handle

Part No#	Delta Part#	Finish
DELU4929PK	U4929-PK	Chrome

Delta Volume Control



. Trickle feature volume control
. Not a positive shut off valve

Part No#	Delta Part#	Finish
DELU4760PK	U4760-PK	Chrome

Delta Vacuum Breaker



. Atmospheric vacuum breaker

Part No#	Delta Part#	Finish
DELU4900PK	U4900-PK	Chrome

Delta Adjustable Wall Mount For Hand Shower



. Concealed mounting screws
. Mounts hand shower to wall

Part No#	Delta Part#	Finish
DELU4005PK	U4005-PK	Chrome
DELU4005SSPK	U4005-SS-PK	Stainless Steel

BATHTUBS & DRAINS

Mustee Fiberglass Bathtub



- . Premium Varistone fiberglass
- . Fits standard 30" x 60" alcove
- . One piece molded construction

Part No#	Color	Type
MUST6030LWHTTUBLH	White	LH
MUST6030RWHTTUBRH	White	RH

Bootz Cast Iron Bathtub



- . Slip resistant bottom
- . One piece construction
- . Acid resistant finish
- . Cast iron body

Part No#	Color	Type
BOOCASTTUBWHITELH	White	LH
BOOCASTTUBWHITERH	White	RH

Bootz Steel Bathtub



- . Slip resistant bottom
- . One piece construction
- . Acid resistant finish
- . Cast iron body

Part No#	Color	Type
BOOTUBWHITELH	White	LH
BOOTUBWHITERH	White	RH
BOOTUBBONELH	Bone	LH
BOOTUBBONERH	Bone	RH

Tubular Shoe Outlet Waste Kit



- . Chrome finish
- . Tubular lift & turn waste kit

Part No#	Size	Type
J&BPVCSHOEOULETTUB	771-PVC BX	Lift & Turn

Gerber Classics Tubular Bath Waste Kits

Part No#	Drain Type	Style	Body	Finish
GER41510	Trip Lever	Standard	PVC	Chrome
GER41818	Trip Lever	Standard	Brass	Chrome
GER41513	Trip Lever	Long (Roman Tub)	PVC	Chrome
GER41540	Toe Touch	Standard	PVC	Chrome
GER41550	Lift & Turn	Standard	PVC	Chrome

Gerber Classics All Glue Bath Waste Kits

Part No#	Drain Type	Style	Body	Finish
GER41542	Toe Touch	Standard	PVC	Chrome
GER41552	Lift & Turn	Standard	PVC	Chrome

NOTE: GERBER CLASSICS ALL GLUE BATH WASTE KITS DO NOT INCLUDE 1-1/2" PVC SANITARY TEE

WATCO All Glue Bath Waste Kits

Part No#	Drain Type	Style	Body	Finish
WATCO901LTPVCCP	Lift & Turn	Standard	PVC	Chrome
WATCO915LTPVCFCP	Lift & Turn	Shoe Outlet	PVC	Chrome
WATCO901LTPVCBN	Lift & Turn	Standard	PVC	Brushed Nickel
WATCO901LTPVCORB	Lift & Turn	Standard	PVC	Oil Rubbed Bronze

NOTE: WATCO ALL GLUE BATH WASTE KITS DO NOT INCLUDE 1-1/2" PVC SANITARY TEE

GERBERIT Bath Waste Cable Drains

Part No#	Drain Type	Style	Body	Finish
GERB151504001	151.504.00.1	Cable Drain	PVC	PVC Body Only
GERB151550211	151.550.21.1	Trim Only	—	Chrome
GERB151551ID1	151.551.ID.1	Trim Only	—	Brushed Nickel
GERB151550DY1	151.550.DY.1	Trim Only	—	White



BATHTUB DRAIN PARTS

Decorative Bath Waste Trim Kits



. To be used with any Gerber bath waste kit
 . Replaces standard chrome trim to decorative trim

Part No#	Type	Finish
GERN6863	Trip Lever	Brushed Nickel
J&BORBTRIMKIT	Trip Lever	Oil Rubbed Bronze
GERN6883	Lift & Turn	Brushed Nickel

Universal Bath Waste Trip Lever Plate Only



. Replacement universal chrome trip lever plate only

Part No#	Type	Finish
PASTRIPLEVERTUB	Trip Lever	Chrome

Gerber Classics Bath Waste Shoe Plug



. Replacement shoe plug only for Gerber bath waste

Part No#	Type	Finish
GER96-121	Shoe Plug	Chrome

Gerber Classic Bath Waste Strainer



. Replacement strainer for Gerber bath waste
 . Replacement chrome plated screw for Gerber bath waste strainer

Part No#	Type	Finish
GER91-292	Strainer	Chrome
GER21-280	Strainer Screw	Chrome

Rubber Bath Waste Overflow Gasket



. Replacement rubber head on gasket for Gerber bath wastes

Part No#	Type	Material
GER91-150	Rubber Gasket	Rubber

Rubber Bath Waste Drain Washer



. Replacement rubber bath drain gasket for Gerber bath wastes

Part No#	Type	Material
GER91-260	Rubber Gasket	Rubber

Fiber Bath Waste Drain Washer



. Replacement fiber bath drain gasket for Gerber bath wastes

Part No#	Type	Material
GER90-390	Fiber Gasket	Fiber

LOOKING FOR A TUB & SHOWER PART NOT LISTED IN THIS CATALOG? GIVE US A CALL WE MAY STILL HAVE IT!

ROMAN TUB/MOEN REPLACEMENT PARTS

Delta Roman Tub Rough Valve



- . Rough Valve for a two handle roman tub faucet
- . 3-hole flexible mounting kit

Part No#	Delta Part#	Type
DELR2707	R2707	Extra Thick

Delta Foundations Roman Tub Trim Kit



- . 3-hole 8" - 16" installation
- . Rough valve not included
- . For rough valve, use Delta part# R2707 or R2707

Part No#	Delta Part#	Finish
DELBT2710	BT2710	Chrome
DELBT2710SS	BT2710-SS	Stainless Steel

Peerless Tunbridge Roman Tub Trim Kit



- . 3-hole 8" - 16" installation
- . Rough valve not included
- . For rough valve, use Delta part# R2707 or R2707



Part No#	Peerless Part#	Finish
PEEROMANTUBTRIM	PTT298510	Chrome

Moen Single Handle Faucet Replacement Cartridge



- . Compatible with Moen #1200
- . Replacement for most Moen single handle faucets and showers prior to 1990

Part No#	Walrich Part#	Type
WALBRASSCART	4304704	Brass



- . Compatible with Moen #1225
- . Replacement for most Moen single handle faucets and showers

Part No#	Walrich Part#	Type
WALPLASTICCART	1304702	Plastic

Moen Two Handle Faucet Replacement Cartridge



- . Compatible with Moen #1224
- . Replacement for most Moen two handle faucets

Part No#	Walrich Part#	Type
WALMOEN1224	1304712	Plastic

Moen Posi-Temp Faucet Replacement Cartridge



- . Compatible with Moen #1222
- . Replacement cartridge for most Moen pressure balanced shower faucets

Part No#	Walrich Part#	Type
WALPOSITEMP	1304705	Plastic

Moen Retainer Clip



- . Compatible with Moen #883
- . For use on any Moen faucet or tub and shower valve

Part No#	Walrich Part#	Type
WALCARTCLIP	1304604	Copper

LAUNDRY TUBS

Mustee UTILITUB Floor Mount Laundry Tub



- . One piece plastic molded construction
- . 15 gallon capacity
- . Includes metal legs
- . Accommodates faucet with 4" spread

Part No#	Size (Outer Dimensions)	Color
MUS12K	18" x 23-1/2"	White

Mustee UTILITUB Floor Mount Laundry Tub



- . One piece plastic molded construction
- . 20 gallon capacity
- . Includes metal legs
- . Accommodates faucet with 4" spread

Part No#	Size (Outer Dimensions)	Color
MUS14K	23" x 25"	White

Mustee Drop In Utility Sink



- . Molded premium fiberglass construction with metal rods for extra strength and durability
- . 17 gallon capacity
- . Self rimming bowl with 3-1/2" drain size for basket strainer (not included)

Part No#	Size (Outer Dimensions)	Color
MUS10CWHITE	25" x 22"	White
MUS10CBONE	25" x 22"	Bone
MUS10CBISC	25" x 22"	Biscuit

Mustee Drop In Utility Sink



- . Molded premium fiberglass construction with metal rods for extra strength and durability
- . 8 gallon capacity
- . Self rimming bowl with 3-1/2" drain size for basket strainer (not included)

Part No#	Size (Outer Dimensions)	Color
MUS11WHITE	20" x 17"	White
MUS11BONE	20" x 17"	Bone

Mustee DURASTONE UTILITUB Floor Laundry Tub



- . High strength one piece molded construction made from a combination of crushed stone and fiberglass
- . 18 gallon capacity
- . Includes metal legs
- . Accommodates faucet with 4" spread

Part No#	Size (Outer Dimensions)	Color
MUS18F	20" x 24"	White

Mustee DURASTONE UTILITUB Wall Laundry Tub



- . High strength one piece molded construction made from a combination of crushed stone and fiberglass
- . 18 gallon capacity
- . Includes wall mounting bracket
- . Accommodates faucet with 4" spread

Part No#	Size (Outer Dimensions)	Color
MUS18W	20" x 24"	White

Mustee DURASTONE UTILITUB Floor Double Tub



- . High strength one piece molded construction made from a combination of crushed stone and fiberglass
- . 38 gallon capacity
- . Includes metal legs
- . Accommodates faucet with 4" spread

Part No#	Size (Outer Dimensions)	Color
MUS26F	40" x 24"	White

Mustee DURASTONE UTILITUB Wall Double Tub



- . High strength one piece construction made from a combination of crushed stone and fiberglass
- . 38 gallon capacity
- . Includes wall mounting bracket
- . Accommodates faucet with 4" spread

Part No#	Size (Outer Dimensions)	Color
MUS26W	40" x 24"	White

Mustee BIGTUB UTILITUB Laundry Tub



- . One piece molded plastic construction
- . 36 gallon capacity
- . Includes metal legs
- . Accommodates faucet with 4" or 8" spread

Part No#	Size (Outer Dimensions)	Color
MUS28F	40" x 24"	White

**LOOKING FOR EXTRA LAUNDRY TUB PARTS
LIKE FLOOR LEGS? GIVE US A CALL! WE
MAY HAVE EXTRA PARTS!**

LAUNDRY TUB FAUCETS & PARTS

Laundry Tub Faucet Block



- . For use when water supply lines are above the tub
- . For use with a clamp on style top feed faucet

Part No#	Description	Type
WALMOUNTINGBLOCK	Mounting Block	Plastic

Gerber Classics Top Feed Laundry Tub Faucet



- . Two lever handle faucet
- . Must be used with a faucet mounting block
- . 2.2 GPM

Part No#	Type	Finish
GER49531	Sweat	Rough Brass
GER49530	FPT	Rough Brass

Replacement Parts

Part No#	Gerber Part#	Part
GER98-688	98-688	Hot Cartridge
GER98-689	98-689	Cold Cartridge

Delta Deck Mount Laundry Tub Faucet



- . 2 or 3-hole 4" spread
- . Durable brass construction

Part No#	Type	Finish
DEL2131	Garden Hose Thread	Chrome
DEL2133	Aerator Thread	Chrome

Delta Foundations Two Handle Bar Prep Faucet



- . 2 or 3-hole 4" spread
- . High arc gooseneck spout

Part No#	Delta Part#	Finish
DELB28910LF	B28910LF	Chrome

Rubber Dishwasher Discharge Hose



- . EPDM tubes with reinforced double-ply spiraled polyester
- . Burst pressure at 280 PSI
- . Sell by the foot

Part No#	Size	Sell Qty
HAR5/8RUBBERHOSE	5/8 ID	FT
HAR7/8RUBBERHOSE	7/8 ID	FT

5' Rubber Washing Machine Hoses



- . Replacement hot & cold hoses for washing machine
- . Both ends contain FHT connections
- . Rubber material

Part No#	Size	Type
HARWASHERHOSE5FT	3/8" ID x 5'	Rubber

Washing Machine Pan



- . Large size to accommodate front load washers
- . Includes 1" PVC male adapter

Part No#	Mustee Part#	Type
MUS96WASHERPAN	96	Plastic

Mop Service Basin Hose & Bracket



- . Hose & Bracket for mop service basin

Part No#	Description	Mustee Part#
MUSHOSE&BRKT	Hose & Bracket	65.700

Double Laundry Tub Twin Waste Kit



- . Twin waste kit to be used with Mustee 26F & 26W

Part No#	Description	Mustee Part#
MUSTWINWASTE	Twin Waste Kit	26.619

Mop Hanger



- . Mop hanger for nearby a mop service basin

Part No#	Description	Mustee Part#
MUSMOPHANGER	Mop Hanger	65.600

Madison Heights Plumbing & Heating Supply

SECTION 4 - VALVES

Ball & Gate Valves	64-66
Inline Check Valves	67
Plastic Valves & Checks	68
Hose Bibbs & Repair	69-70
Pressure Vacuum Breakers	71
Reduced Pressure Assemblies	72-73
Backflow Preventers	74
Miscellaneous Valves	75

BALL VALVES

Copper Full Port Ball Valve



- . Full port lever handle
- . WOG approved
- . Lead free

Part No#	Size	Type
LEG1/2COPBALLVALVE	1/2"	C x C
LEG3/4COPBALLVALVE	3/4"	C x C
LEG1COPBALLVALVE	1"	C x C
LEG11/4COPBALLVALVE	1-1/4"	C x C
LEG11/2COPBALLVALVE	1-1/2"	C x C
LEG2COPBALLVALVE	2"	C x C
LEG21/2COPBALLVALVE	2-1/2"	C x C
LEG3COPBALLVALVE	3"	C x C
LEG4COPBALLVALVE	4"	C x C

Copper Full Port Ball Valve With Drain Port



- . Full port lever handle
- . WOG approved
- . Lead free
- . Includes 1/8 drain port with cap

Part No#	Size	Type
LEG1/2COPBALLW/DRAIN	1/2"	C x C
LEG3/4COPBALLW/DRAIN	3/4"	C x C
LEG1COPBALLW/DRAIN	1"	C x C

Threaded Full Port Ball Valve



- . Full port lever handle
- . WOG approved
- . Lead free

Part No#	Size	Type
LEG1/4IPBALLVALVE	1/4"	FPT x FPT
LEG3/8IPBALLVALVE	3/8"	FPT x FPT
LEG1/2IPBALLVALVE	1/2"	FPT x FPT
LEG3/4IPBALLVALVE	3/4"	FPT x FPT
LEG1IPBALLVALVE	1"	FPT x FPT
LEG11/4IPBALLVALVE	1-1/4"	FPT x FPT
LEG11/2IPBALLVALVE	1-1/2"	FPT x FPT
LEG2IPBALLVALVE	2"	FPT x FPT
LEG21/2IPBALLVALVE	2-1/2"	FPT x FPT
LEG3IPBALLVALVE	3"	FPT x FPT
LEG4IPBALLVALVE	4"	FPT x FPT

Threaded Full Port Ball Valve With Drain Port



- . Full port lever handle
- . WOG approved
- . Lead free
- . Includes 1/8 drain port with cap

Part No#	Size	Type
LEG1/2IPBALLW/DRAIN	1/2"	FPT x FPT
LEG3/4IPBALLW/DRAIN	3/4"	FPT x FPT
LEG1IPBALLW/DRAIN	1"	FPT x FPT

Copper Press Full Port Ball Valve



- . Full port lever handle
- . Not approved for gas, WATER ONLY!

Part No#	Size	Type
LEG1/2PRESSBALLVALVE	1/2"	Press x Press
LEG3/4PRESSBALLVALVE	3/4"	Press x Press
LEG1PRESSBALLVALVE	1"	Press x Press
LEG11/4PRESSBALLVALVE	1-1/4"	Press x Press
LEG11/2PRESSBALLVALVE	1-1/2"	Press x Press
LEG2PRESSBALLVALVE	2"	Press x Press
LEG21/2PRESSBALLVALVE	2-1/2"	Press x Press
LEG3PRESSBALLVALVE	3"	Press x Press
LEG4PRESSBALLVALVE	4"	Press x Press

Copper Press Full Port Ball Valve With Drain



- . Full port lever handle
- . Not approved for gas, WATER ONLY!
- . Includes 1/8 drain port with cap

Part No#	Size	Type
LEG1/2PRESSBALLW/DRA	1/2"	Press x Press
LEG3/4PRESSBALLW/DRA	3/4"	Press x Press
LEG1PRESSBALLW/DRAIN	1"	Press x Press

Compression Full Port Ball Valve



- . Full port lever handle

Part No#	Size	Type
LEG1/2COMPBALLVALVE	1/2"	MComp x MComp
LEG3/4COMPBALLVALVE	3/4"	MComp x MComp
LEG1COMPBALLVALVE	1"	MComp x MComp

BALL VALVES/GATE VALVES

Insta-Loc Push Full Port Ball Valve



- . Full port lever handle
- . Works on PEX, CPVC & copper piping
- . CTS pipe size
- . Lead free

Part No#	Size	Type
LEG1/2INSTALOCBALLVA	1/2"	Push x Push
LEG3/4INSTALOCBALLVA	3/4"	Push x Push
LEG1INSTALOCBALLVALV	1"	Push x Push

Copper x PEX Full Port Ball Valve With Drain Port



- . Adapts copper sweat connection to PEX connection
- . Full port lever handle
- . Includes 1/8 drain port with cap
- . Lead free

Part No#	Size	Type
LEG1/2COPXPEXBALLW/D	1/2"	C x PEX
LEG3/4COPXPEXBALLW/D	3/4"	C x PEX

PEX Full Port Ball Valve



- . Full port lever handle
- . Lead free

Part No#	Size	Type
LEG1/2PEXBALLVALVE	1/2"	PEX x PEX
LEG3/4PEXBALLVALVE	3/4"	PEX x PEX
LEG1PEXBALLVALVE	1"	PEX x PEX

PEX Full Port Ball Valve With Drain Port



- . Includes 1/8 drain port with cap
- . Lead free

Part No#	Size	Type
LEG1/2PEXBALLW/DRAIN	1/2"	PEX x PEX
LEG3/4PEXBALLW/DRAIN	3/4"	PEX x PEX

AGA Gas Ball Valve



- . Two piece brass body gas valve
- . Not for use with potable water

Part No#	Size	Type
LEG3/8AGAGASVALVE	3/8"	FPT x FPT
LEG1/2AGAGASVALVE	1/2"	FPT x FPT
LEG3/4AGAGASVALVE	3/4"	FPT x FPT

AGA Flare Gas Ball Valve



- . One piece brass body gas valve
- . Not for use with potable water
- . Brass flare nuts not included

Part No#	Size	Type
LEG3/8FLXFLAGAGASVAL	3/8"	Flare x Flare

AGA Adapting Gas Ball Valve



- . One piece brass body gas valve
- . Not for use with potable water

Part No#	Size	Type
LEG3/8FLx1/2FIPAGAGA	1/2" x 3/8"	FPT x Flare
LEG1/2FLx1/2FIPAGAGA	1/2" x 1/2"	FPT x Flare
LEG3/8FLx1/2MIPAGAGA	1/2" x 3/8"	MPT x Flare

Copper Full Turn Gate Valve



- . Full turn handle
- . WOG approved
- . Brass body
- . Lead free

Part No#	Size	Type
LEG1/2COPGATEVALVE	1/2"	C x C
LEG3/4COPGATEVALVE	3/4"	C x C
LEG1COPGATEVALVE	1"	C x C
LEG11/4COPGATEVALVE	1-1/4"	C x C
LEG11/2COPGATEVALVE	1-1/2"	C x C
LEG2COPGATEVALVE	2"	C x C
LEG21/2COPGATEVALVE	2-1/2"	C x C

FPT Full Turn Gate Valve



- . Full turn handle
- . WOG approved
- . Brass body
- . Lead free

Part No#	Size	Type
LEG1/2IPGATEVALVE	1/2"	FPT x FPT
LEG3/4IPGATEVALVE	3/4"	FPT x FPT
LEG1IPGATEVALVE	1"	FPT x FPT
LEG11/4IPGATEVALVE	1-1/4"	FPT x FPT
LEG11/2IPGATEVALVE	1-1/2"	FPT x FPT
LEG2IPGATEVALVE	2"	FPT x FPT
LEG21/2IPGATEVALVE	2-1/2"	FPT x FPT
LEG3IPGATEVALVE	3"	FPT x FPT

BALL VALVES/GATE VALVES

MPT Full Turn Boiler Drain Valve



- . Full turn handle
- . Lead free

Note: 1/2 MPT boiler drain valve will also accept a 1/2 copper fitting for a solder connection

Part No#	Size	Type
LEG1/2MIPBOILERDRAIN	1/2" x 3/4"	MPT x MHT
LEG3/4MIPBOILERDRAIN	3/4" x 3/4"	MPT x MHT

MPT 1/4 Turn Boiler Drain Valve



- . Lever ball valve style handle
- . Lead free

Note: 1/2 MPT boiler drain valve will also accept a 1/2 copper fitting for a solder connection

Part No#	Size	Type
LEG1/21/4TURNBOILERD	1/2" x 3/4"	MPT x MHT

Copper Full Turn Fitting Boiler Drain Valve



- . Full turn handle
- . Lead free
- . Designed to go into a copper fitting for a solder connection

Part No#	Size	Type
LEG1/2FTGSWTBOILERDR	1/2" x 3/4"	FTG x MHT

PEX Full Turn Boiler Drain Valve



- . Full turn handle
- . Lead free
- . Includes adapter for a PEX connection

Part No#	Size	Type
LEG1/2PEXBOILERDRAIN	1/2" x 3/4"	PEX x MHT

Replacement Drain Port Cap



- . Replacement drain cap for any valve with a drain port

Part No#	Size	Type
LEGDRAINCAP1/8	1/8"	Fcomp

Copper Full Turn Stop & Waste Gate Valve



- . Full turn handle
- . Lead free
- . Includes 1/8 drain port with cap

Part No#	Size	Type
LEG1/2COPSTOP&WASTE	1/2"	C x C
LEG3/4COPSTOP&WASTE	3/4"	C x C

FPT Full Turn Stop & Waste Gate Valve



- . Full turn handle
- . Lead free
- . Includes 1/8 drain port with cap

Part No#	Size	Type
LEG3/4IPSTOP&WASTE	3/4"	FPT x FPT

Compression Full Turn Stop & Waste Gate Valve



- . Full turn handle
- . Lead free
- . Includes 1/8 drain port with cap

Part No#	Size	Type
LEG1/2COMPSTOP&WAST	1/2"	Mcomp x Mcomp
LEG3/4COMPSTOP&WAST	3/4"	Mcomp x Mcomp

Water Heater Drain Valves



- . 1/4 turn handle

Part No#	Size	Type
LEG3/4HEATERDRAINVAL	3/4" x 3/4"	MPT x MHT



- . Ball style handle

Part No#	Size	Type
LEG1/2BALLVALVEHOSEB	1/2" x 3/4"	MPT x MHT

BRASS SWING/SPRING CHECK VALVES

Copper Swing Check Valve



- . Lead free
- . Can be used for both horizontal and vertical installation
- . Copper sweat connection

Part No#	Size	Type
LEG1/2COPSWINGCHECK	1/2"	C x C
LEG3/4COPSWINGCHECK	3/4"	C x C
LEG1COPSWINGCHECK	1"	C x C
LEG11/4COPSWINGCHECK	1-1/4"	C x C
LEG11/2COPSWINGCHECK	1-1/2"	C x C
LEG2COPSWINGCHECK	2"	C x C
LEG21/2COPSWINGCHECK	2-1/2"	C x C
LEG3COPSWINGCHECK	3"	C x C

Threaded Swing Check Valve



- . Lead free
- . Can be used for both horizontal and vertical installation
- . Female threaded connection

Part No#	Size	Type
LEG1/2IPSWINGCHECK	1/2"	FPT x FPT
LEG3/4IPSWINGCHECK	3/4"	FPT x FPT
LEG1IPSWINGCHECK	1"	FPT x FPT
LEG11/4IPSWINGCHECK	1-1/4"	FPT x FPT
LEG11/2IPSWINGCHECK	1-1/2"	FPT x FPT
LEG2IPSWINGCHECK	2"	FPT x FPT
LEG21/2IPSWINGCHECK	2-1/2"	FPT x FPT
LEG3IPSWINGCHECK	3"	FPT x FPT

Copper Press Swing Check Valve



- . Lead free
- . Can be used for both horizontal and vertical installation
- . Copper press connection

Part No#	Size	Type
LEG1/2PRESSSWINGCHEC	1/2"	Press x Press
LEG3/4PRESSSWINGCHEC	3/4"	Press x Press
LEG1PRESSSWINGCHECK	1"	Press x Press

Copper Spring Check Valve



- . Lead free
- . Can be used for both horizontal and vertical installation
- . Copper sweat connection

Part No#	Size	Type
LEG1/2COPSPRINGCHECK	1/2"	C x C
LEG3/4COPSPRINGCHECK	3/4"	C x C
LEG1COPSPRINGCHECK	1"	C x C

Threaded Spring Check Valve



- . Lead free
- . Can be used for both horizontal and vertical installation
- . Female threaded connection

Part No#	Size	Type
LEG1/2IPSPRINGCHECK	1/2"	FPT x FPT
LEG3/4IPSPRINGCHECK	3/4"	FPT x FPT
LEG1IPSPRINGCHECK	1"	FPT x FPT
LEG11/4IPSPRINGCHECK	1-1/4"	FPT x FPT
LEG11/2IPSPRINGCHECK	1-1/2"	FPT x FPT
LEG2IPSPRINGCHECK	2"	FPT x FPT

Copper Press Spring Check Valve



- . Lead free
- . Can be used for both horizontal and vertical installation
- . Copper press connection

Part No#	Size	Type
LEG1/2PRESSSPRINGCHE	1/2"	Press x Press
LEG3/4PRESSSPRINGCHE	3/4"	Press x Press
LEG1PRESSSPRINGCHECK	1"	Press x Press

PVC Full Port Ball Valve



- . One piece PVC body
- . Standard port handle
- . For water supply only, not to be used with compressed air

Part No#	Size	Type
LEG1/2PVCBALLVALVE	1/2"	H x H
LEG3/4PVCBALLVALVE	3/4"	H x H
LEG1PVCBALLVALVE	1"	H x H
LEG11/2PVCBALLVALVE	1-1/2"	H x H
LEG2PVCBALLVALVE	2"	H x H

CPVC Full Port Ball Valve



- . One piece CPVC body
- . Standard port handle
- . For water supply only, not to be used with compressed air

Part No#	Size	Type
LEG1/2CPVCBALLVALVE	1/2"	H x H
LEG3/4CPVCBALLVALVE	3/4"	H x H
LEG1CPVCBALLVALVE	1"	H x H

PVC Backwater Valve



- . Plastic sleeve included with all sizes besides 1-1/2"
- . PVC body includes plastic lid and flapper with O-ring gaskets to seal out any sewer gas
- . Designed for horizontal applications only

Part No#	Size	Type
LEG11/2BACKWATERVALV	1-1/2" (Less Sleeve)	H x H
CAN2BACKWATERVALVE	2" (With Sleeve)	H x H
CAN3BACKWATERVALVE	3" (With Sleeve)	H x H
CAN4BACKWATERVALVE	4" (With Sleeve)	H x H

PVC Extendable Exterior Backwater Valve



- . Designed for exterior use
- . Designed for horizontal applications only
- . Includes female PVC adapter with raised plug
- . Heavy duty rubber flapper

Part No#	Size	Type
PVCCLEANSEAL4	4"	H x H
PVCCLEANSEAL6	6"	H X H

LOOKING FOR REPLACEMENT PARTS FOR A BACKWATER VALVE? GIVE US A CALL! WE MIGHT HAVE EXTRA PARTS!

Zoeller PVC Sump Check Valve



- . Includes rubber couplings with hose clamps
- . Designed for vertical installation only

Part No#	Size	Type
ZOE11/2CHECKVALVE	1-1/2"	PL/CI x PL/CI
ZOE2PVCHECKVALVE	2"	PL/CI x PL/CI

PVC Silent Sump Check Valve



- . Rubber coupling connection
- . Designed for vertical installation only
- . Soft closing flapper to reduce noise

Part No#	Size	Type
ZOE11/2QUIETCHECK	1-1/2"	H x H

Legend PVC Sump Check Valve



- . Includes rubber couplings with hose clamps
- . Designed for vertical installation only

Part No#	Size	Type
LEG11/2SUMPCKECS	1-1/2"	PL/CI x PL/CI

PVC Union Sump Check Valve



- . PVC solvent connection with unions
- . Designed for vertical installation only

Part No#	Size	Type
LEG11/2UNIONCHECKVAL	1-1/2"	H x H
LEG2UNIONCHECKVALVE	2"	H x H

Cast Iron Sump Check Valve



- . Includes rubber couplings with hose clamps
- . Heavy duty cast iron body
- . Designed for vertical installation only

Part No#	Size	Type
ZOE2CICHECKVALVE	2"	PL/CI x PL/CI

Copper Full Turn Sillcock



- . Full turn handle
- . Includes brass flange
- . Lead free

Part No#	Size	Type
LEG1/2COPSILLCOCK	1/2" x 3/4"	C x MHT
LEG3/4COPSILLCOCK	3/4" x 3/4"	C x MHT

Copper 1/4 Turn Sillcock



- . Lever ball valve style handle
- . Includes brass flange
- . Lead free

Part No#	Size	Type
LEG1/2COP1/4TURNSILC	1/2" x 3/4"	C x MHT

FPT Full Turn Sillcock



- . Full turn handle
- . Includes brass flange
- . Lead free

Part No#	Size	Type
LEG1/2COPSILCOCK	1/2" x 3/4"	C x MHT
LEG3/4COPSILCOCK	3/4" x 3/4"	C x MHT

PEX Full Turn Sillcock



- . Full turn handle
- . Includes brass flange
- . Includes adapter for PEX connection
- . Lead free

Part No#	Size	Type
LEG1/2PEXSILLCOCK	1/2" x 3/4"	PEX x MHT

Prier Full Turn Hose Bibb



- . Plastic full turn handle
- . Includes built in vacuum breaker with chrome cap
- . End connection accepts both copper fitting or an FPT connection

Part No#	Size	Type
PRI478-6	1/2" x 6"	C/MPT x MHT
PRI478-8	1/2" x 8"	C/MPT x MHT
PRI478-10	1/2" x 10"	C/MPT x MHT
PRI478-12	1/2" x 12"	C/MPT x MHT
PRI478-14	1/2" x 14"	C/MPT x MHT

Prier Loose Key Hose Bibb



- . Less handle
- . Includes built in vacuum breaker with chrome cap
- . End connection accepts both copper fitting or an FPT connection

Part No#	Size	Type
PRIC244D8	1/2" x 8"	C/MPT x MHT
PRIC244D10	1/2" x 10"	C/MPT x MHT
PRIC244D12	1/2" x 12"	C/MPT x MHT

Legend Full Turn Hose Bibb



- . Full turn handle
- . Includes built in vacuum breaker with black plastic cap
- . End connection accepts both copper fitting or an FPT connection

Part No#	Size	Type
LEG8FFSILLCOCK	1/2" x 8"	C/MPT x MHT
LEG10FFSILLCOCK	1/2" x 10"	C/MPT x MHT
LEG12FFSILLCOCK	1/2" x 12"	C/MPT x MHT

Legend Full Turn PEX Hose Bibb



- . Full turn handle
- . Includes built in vacuum breaker with black plastic cap
- . Includes adapter for PEX connection

Part No#	Size	Type
LEG8PEXFFSILLCOCK	1/2" x 8"	PEX x MHT
LEG10PEXFFSILLCOCK	1/2" x 10"	PEX x MHT
LEG12PEXFFSILLCOCK	1/2" x 12"	PEX x MHT

Woodford Commercial Wall Hydrant



- . Automatic draining freeze proof wall hydrant
- . Loose key commercial style
- . Includes built in chrome vacuum breaker

Part No#	Size	Type
WOO65C-4	3/4" x 4"	C
WOO65C-6	3/4" x 6"	C
WOO65C-8	3/4" x 8"	C
WOO65C-10	3/4" x 10"	C
WOO65C-12	3/4" x 12"	C

Woodford Commercial Wall Hydrant With Box



- . Round box assembly with door for Woodford model #67

Part No#	Size	Type
WOO67RDBOX	12"	

HOSE BIBB REPAIR & VACUUM BREAKERS

Woodford Hot & Cold Wall Faucet



- . Built in pressure relief valve
- . Built in vacuum breaker

Part No#	Size	Type
WOO22CP-8MH	1/2" x 8"	C/MPT x MHT
WOO22CP-10MH	1/2" x 10"	C/MPT x MHT
WOO22CP-12MH	1/2" x 12"	C/MPT x MHT

LOOKING FOR PARTS FOR A WOODFORD OR SOMETHING NOT LISTED IN THIS CATALOG? GIVE US A CALL! WE MAY HAVE EXTRA PARTS!

Prier Hose Bibb Repair Parts



. Replacement parts for Prier hose bibbs



Part No#	Description	Prier Part No#
MAN7755/7754	Complete Rebuild Kit	630-7755
MAN6307965	Replacement Handle	630-7965
MAN7500	Vacuum Breaker Kit	630-7500

Legend Hose Bibb Repair Parts



. Replacement vacuum breaker for Legend frost free hose bibbs

Part No#	Size	Type
LEGFROSTFREEREPARK	Vacuum Breaker Kit	Rebuild Kit

Watts Anti Siphon Vacuum Breaker



- . Lead free
- . ASSE 1001
- . Usually recommended for low flow installation

Part No#	Size	Type
WAT288A1/2RBVB	1/2"	Rough Brass
WAT288AC1/2CPVB	1/2"	Chrome
WAT288AC3/4CPVB	3/4"	Chrome
WAT0887171	1/2"	Rebuild Kit

Hose Bibb Anchor Kit



- . Supports any style hose bibb on all types of material
- . Works on 1/2", 3/4" & 1" tubing size

Part No#	Size	Type
PASHOSEBIBBANCHOR	1/2"-1"	Anchor Kit

4-Way Stem Key



- . Works on the following stem sizes: 1/4", 9/32", 5/16", 11/32"

Part No#	Description	Type
EMC4WAYSTEMKEY	4-Way Stem Key	Metal

Rough Brass Vacuum Breaker



- . Lead free
- . ASSE 1011

Part No#	Size	Type
LEG3/4RBVACUUMBREAK	3/4"	FHT

Rough Brass Self Draining Vacuum Breaker



- . Lead free
- . Automatically drains to prevent freezing
- . ASSE 1011

Part No#	Size	Type
LEG3/4SELFDRAINVB	3/4"	FHT

Chrome Plated Vacuum Breaker



- . Lead free
- . Chrome plated
- . ASSE 1011

Part No#	Size	Type
LEG3/4CPVACUUMBREAK	3/4"	FHT

Wilkins Pressure Vacuum Breaker Less Union



- . Used for back siphonage protection mainly in irrigation systems
- . Not for use on potable water systems
- . ASSE 1020

Part No#	Size	Type
WIL720A1/2	1/2"	FPT
WIL720A3/4	3/4"	FPT
WIL720A1	1"	FPT
WIL720A11/2	1-1/2"	FPT
WIL720A2	2"	FPT

Wilkins Pressure Vacuum Breaker With Union



- . Used for back siphonage protection mainly in irrigation systems
- . Not for use on potable water systems
- . Includes union for easy removal
- . ASSE 1020

Part No#	Size	Type
WIL720AU1	1"	FPT

Gasket For 1" Pressure Vacuum Breaker



- . Replacement rubber gasket for Wilkins 1" 720 vacuum breaker

Part No#	Size	Type
WIL85313	1"	Rubber

Test Cock



- . Used to allow testing on backflow device
- . Easy screwdriver style handle

Part No#	Size	Type
LEG1/8TESTCOCK	1/4" x 1/8"	FPT x FPT
LEG1/4TESTCOCK	1/4" x 1/4"	FPT x FPT

Wilkins Spill Proof Pressure Vacuum Breaker



- . Used for back siphonage protection mainly in irrigation systems
- . Not for use on potable water systems
- . Spill proof feature designed for indoor use
- . ASSE 1056

Part No#	Size	Type
WIL460XL1/2	1/2"	FPT
WIL460XL3/4	3/4"	FPT
WIL460XL1	1"	FPT

Wilkins Pressure Vacuum Breaker Rebuild Kits



- . Rebuild kits for Zurn Wilkins pressure vacuum breakers

Part No#	Description	Size
WILRK1420	Wilkins 420 Rebuild Kit	1"
WILRK1720	Wilkins 720 Rebuild Kit	1/2" - 1"
WILRK2720	Wilkins 720 rebuild Kit	1-1/4" - 2"

Febco Pressure Vacuum Breaker Rebuild Kits



- . Rebuild kits for Febco pressure vacuum breakers

Part No#	Description	Size
FEB905051	Febco 765 Check Kit	1/2", 3/4"
FEB905211	Febco 765 Bonnet/Poppet Kit	1/2", 3/4"
FEB905052	Febco 765 Check Kit	1", 1-1/4"
FEB905212	Febco 765 Bonnet/Poppet Kit	1", 1-1/4"
FEB905021	Febco 765 Rubber Kit	1", 1-1/4"
FEB901857	Febco 765 Bonnet Kit	1-1/2", 2"
FEB901860	Febco 765 Poppet Kit	1-1/2", 2"
FEB905070	Febco 765 Check Kit	1-1/2", 2"
FEB905022	Febco 765 Rubber Kit	1-1/2", 2"
FEB905044	Febco 825Y Check Kit	3/4" - 1-1/4"
FEB905055	Febco 825Y Check Kit	1-1/2", 2"
FEB905111	Febco 825Y Rubber Kit	3/4" - 1-1/4"
FEB905112	Febco 825Y Rubber Kit	1-1/2" - 2"

Febco Reduced Pressure Assembly Rebuild Kits



- . Rebuild kits for Febco reduced pressure assemblies

Part No#	Description	Size
FEB905355	Febco 860 Rubber Kit	1/2", 3/4"
FEB905356	Febco 860 Rubber Kit	1"
FEB905357	Febco 860 Rubber Kit	1-1/4" - 2"

Zurn Wilkins Reduced Pressure Assembly



- . Zurn Wilkins model# 375XL
- . ASSE 1013
- . Reinforced nylon body to better withstand harsh conditions
- . Removable vessel allows for easy repair
- . Air gap drain not included

Part No#	Size	Type
WIL375XL1/2	1/2"	FPT x FPT
WIL375XL3/4	3/4"	FPT x FPT
WIL375XL1	1"	FPT x FPT
WIL375XL11/2	1-1/2"	FPT x FPT
WIL375XL2	2"	FPT x FPT

Air Gap For Wilkins Reduced Pressure Assembly



- . Fits Zurn Wilkins model# 375XL reduced pressure assemblies
- . Plastic body

Part No#	Fits RPZ Size	Drain Size
WILAG11	1/2", 3/4", 1"	2" DWV
WILAG12	1-1/2", 2"	3" DWV

Zurn Wilkins Double Check Backflow Preventer



- . Lead free
- . Used for back siphonage protection
- . No drain assembly needed

Part No#	Size	Type
WIL350XL3/4	3/4"	FPT
WIL350XL1	1"	FPT
WIL350XL11/2	1-1/2"	FPT
WIL350XL2	2"	FPT

Wilkins Reduced Pressure Assembly Rebuild Kits



- . Rebuild kits for Zurn Wilkins reduced pressure assemblies

Part No#	Description	Size
WILRK34375R	Wilkins 375 Rubber Kit	1/2", 3/4"
WILRK1375R	Wilkins 375 Rubber Kit	1"
WILRK114375R	Wilkins 375 Rubber Kit	1-1/4" - 2"
WILRK14975XL1/2	Wilkins 975 Rebuild Kit	1/4" - 1/2"
WILRK34975XLR	Wilkins 975 Rubber Kit	3/4", 1"
WILRK34975XLC	Wilkins 975 Complete Kit	3/4", 1"
WILRK114975XLR	Wilkins 975 Rubber Kit	1-1/4" - 2"
WILRK114975XLC	Wilkins 975 Complete Kit	1-1/4" - 2"

WATTS REDUCED PRESSURE ASSEMBLIES & PARTS

Watts Reduced Pressure Assembly



- . Complete brass body
- . ASSE 1013
- . Separate check valve covers for easy maintenance
- . Air gap drain not included

Part No#	Size	Type
WAT9191/2	1/2"	FPT
WAT9193/4	3/4"	FPT
WAT9191	1"	FPT
WAT91911/2	1-1/2"	FPT
WAT9192	2"	FPT

Air Gap For Watts Reduced Pressure Assembly



- . Bronze air gap drain for Watts 919 device
- . Female pipe thread connection

Part No#	Fits RPZ Size	Outlet Size
WAT919AGC	3/4", 1"	1/2" FPT
WAT919AGF	1-1/4" - 2"	2" FPT

Vent Elbow For Watts Reduced Pressure Assembly



- . Bronze air gap drain elbow for Watts 919 device
- . Used for vertical installation

Part No#	Fits RPZ Size	Type
WAT919ELC	1/2" - 1"	Brass
WAT919ELF	1-1/4" - 2"	Brass

Watts Reduced Pressure Assembly Rebuild Kits



- . Rebuild kits for Watts reduced pressure assemblies

Part No#	Description	Size
WAT0887297	Watts 009 Rubber Kit	1/4" - 1/2"
WAT0887291	Watts 009 First Check	1/4" - 1/2"
WAT0887292	Watts 009 Second Check	1/4" - 1/2"
WAT0887182	Watts 009 Rubber Kit	3/4", 1"
WAT0887185	Watts 009 Rubber Kit	1-1/4" - 2"
WAT0887280	Watts 009M1 Rubber Kit	1-1/4" - 2"
WAT0886999	Watts 009M2 Rubber Kit	3/4"
WAT0887787	Watts 009M2 Rubber Kit	1"
WAT0887309	Watts 009M2 Rubber Kit	1-1/4", 1-1/2"
WAT0887547	Watts 009M2 Rubber Kit	2"
WAT0888526	Watts 009M3 Rubber Kit	3/4"
WAT0888012	Watts 008 Bonnet Kit	1/2", 3/4"
WAT0887972	Watts 008 Check Kit	3/4", 1/2"
WAT0887710	Watts 800M4 Vent Kit	1"
WAT0887704	Watts 800M4 Check Kit	1"
WAT0887701	Watts 800M4 Bonnet Kit	1"
WAT0794069	Watts 909 Rubber Kit	3/4", 1"
WAT0794070	Watts 909 Rubber Kit	1-1/4" - 2"
WAT0888140	Watts 919 Rubber Kit	1/4" - 1/2"
WAT0888141	Watts 919 Rubber Kit	3/4"
WAT0888142	Watts 919 Rubber Kit	1"
WAT0888143	Watts 919 Rubber Kit	1-1/4" - 1-1/2"
WAT0888144	Watts 919 Rubber Kit	2"

BACKFLOW PREVENTERS

Bronze Wye Strainer



- . Typically installed before an RPZ to prevent solids from entering the device
- . Easy cleanout access with strainer screen

Part No#	Size	Type
LEG1/2IPWYESTRAINER	1/2"	FPT
LEG3/4IPWYESTRAINER	3/4"	FPT
LEG1IPWYESTRAINER	1"	FPT
LEG11/4IPWYESTRAINER	1-1/4"	FPT
LEG11/2IPWYESTRAINER	1-1/2"	FPT
LEG2IPWYESTRAINER	2"	FPT

Bronze Wye Check Valve



- . Y-Pattern style check valve
- . Easy access to fix damaged parts or clean

Part No#	Size	Type
LEG2IPWYECHECKS	2"	FPT

Dual Check Less Vent



- . Lead free
- . ASSE 1024
- . No drain port for indoor use
- . Can be installed horizontally and vertically

Part No#	Size	Type
LEG1/2IPDUALCHECK	1/2"	FPT
LEG3/4IPDUALCHECK	3/4"	FPT
LEG1IPDUALCHECK	1"	FPT

Dual Check With Atmospheric Vent



- . ASSE 1012
- . Compact design
- . Includes atmospheric vent
- . Can be installed horizontally and vertically

Part No#	Size	Type
WAT9D1/2	1/2"	FPT
WAT9D3/4	3/4"	FPT
WAT9D3/4SWEAT	3/4"	C

Carbonated Backflow Preventer



- . Designed for installation on carbonated beverage lines to prevent back siphonage
- . Stainless steel body with built in wye strainer
- . 1/8 FPT vent outlet
- . ASSE 1022

Part No#	Size	Type
WIL7403/8	3/8"	FPT

Watts SD3 Backflow Preventer With Wye Strainer



- . Designed for installation on carbonated beverage lines to prevent back siphonage
- . Stainless steel body with plastic exposed wye strainer
- . 1/8 FPT vent outlet
- . ASSE 1022

Part No#	Size	Type
WATSD3FN3/8	3/8"	FPT

Watts Anti Siphon Vacuum Breaker



- . Lead free
- . ASSE 1001
- . Usually recommended for low flow installation

Part No#	Size	Type
WAT288A1/2RBVB	1/2"	Rough Brass
WAT288AC1/2CPVB	1/2"	Chrome
WAT288AC3/4CPVB	3/4"	Chrome
WAT0887171	1/2"	Rebuild Kit

Chrome Log Lighter Valve



- . Kit includes cast iron bar, valve & key
- . Chrome finish

Part No#	Size	Type
LEGCPANGLELIGHTER	1/2" FPT	Angle
LEGCPSTRLOGLIGHTERVA	1/2" FPT	Straight

Brass Log Lighter Valve



- . Kit includes cast iron bar, valve and key
- . Polished brass finish

Part No#	Size	Type
LEGPBANGLELIGHTER	1/2" FPT	Angle

Log Lighter Valve Keys



- . Keys for log lighter valves

Part No#	Size	Type
LEG3CPLOGLIGHTERKEY	3"	Chrome
LEG8CPLOGLIGHTERKEY	8"	Chrome
LEG3PBLOGLIGHTERKEY	3"	Brass
LEG8PBLOGLIGHTERKEY	8"	Brass

Pressure Reducing Valve



- . Reduces high inlet pressure to low outlet pressure
- . ASSE 1003
- . Ranges 25 PSI to 75 PSI
- . Factory set at 50 PSI

Part No#	Size	Type
WIL600XL1/2	1/2"	
WIL600XL3/4	3/4"	
WIL600XL1	1"	

Low Pressure Reducing Valve



- . Reduces high inlet pressure to low outlet pressure
- . ASSE 1003
- . Ranges 10 PSI to 35 PSI
- . Factory set at 20 PSI

Part No#	Size	Type
WIL600LPVXL3/4	3/4"	

Copper Balancing Valve



- . Screwdriver style handle
- . Brass body

Part No#	Size	Type
LEG1/2COPBALANCINGVA	1/2"	Copper
LEG3/4COPBALANCINGVA	3/4"	Copper

ADA Hand Sink Tempering Valve



- . Mixes hot and cold water usually in commercial applications to reduce the risk of scalding
- . ASSE 1070
- . Compact design to fit under a lavatory
- . Lead free

Part No#	Size	Type
WATUSG3/8	3/8"	Mcomp

Inline Tempering Valve



- . Mixes hot and cold water usually in commercial applications to reduce the risk of scalding
- . ASSE 1070

Part No#	Size	Type
WATMMVUS1/2	1/2"	Copper
WATMMVUS1/2PEX	1/2"	PEX
WATMMVUS3/4	3/4"	Copper
WATMMVUS1	1"	Copper

Vacuum Relief For Electric Water Heater



- . Designed for use on water heater lines to protect against internal vacuum conditions that could damage a system
- . Could also be used on storage tanks
- . Brass body

Part No#	Size	Type
WILVR10XL	3/4"	MPT

Madison Heights Plumbing & Heating Supply

SECTION 5 -

PIPE & FITTINGS

Pipe	78-80
Water Service Fittings	81
Compression Fittings	82-83
Garden Hose Fittings	84
Flexible Gas Pipe	85-86
Flare Fittings	87-88
Brass & Plastic Push Fittings	89-90
Plastic & Chrome Tubular	91-93
PEX Fittings	94-96

Black Malleable Fittings	97-103
Galvanized Malleable Fittings	104-107
Chrome Fittings	108
Brass Fittings	109-112
Copper & Cast Brass Fittings	113-120
Copper DWV Fittings	121-122
Copper Press Fittings	123-127
Rubber Couplings	128-129
Cast Iron No Hub Fittings	130-133
Closet Flanges & Repair.....	134-135
PVC DWV Fittings	136-141
PVC Schedule 30 Fittings	142-143
PVC Pressure Fittings	144-145
CPVC Fittings	146-147
Sewer & Drain Fittings	148-149

PVC Schedule 40 Pipe



. Schedule 40 rated for both pressure and drainage applications

Part No#	Size	length	Type
PVCPPIPE1/2X10	1/2"	10'	Plain
PVCPPIPE3/4X10	3/4"	10'	Plain
PVCPPIPE1X10	1"	10'	Plain
PVCPPIPE11/2X10	1-1/2"	10'	Plain
PVCPPIPE2X10	2"	10'	Plain
PVCPPIPE3X10	3"	10'	Plain
PVCPPIPE3X10BE	3"	10'	Bell
PVCPPIPE4X10	4"	10'	Plain
PVCPPIPE4X10BE	4"	10'	Bell
PVCPPIPE6X10PE	6"	10'	Plain
PVCPPIPE6X10BE	6"	10'	Bell
PVCPPIPE8X10PE	8"	10'	Plain
PVCPPIPE8X10BE	8"	10'	Bell
PVCPPIPE8X20BE	8"	20'	Bell
PVCPPIPE10X10PE	10"	10'	Plain
PVCPPIPE10X10BE	10"	10'	Bell
PVCPPIPE8X20BE	10"	20'	Bell

PVC Schedule 40 Cellular Core Pipe



. Schedule 40 cellular core rated for drainage purposes only

Part No#	Size	length	Type
PVCPPIPE11/2X10FOAM	1-1/2"	10'	Plain
PVCPPIPE2X10FOAM	2"	10'	Plain
PVCPPIPE3X10FOAM	3"	10'	Plain
PVCPPIPE4X10FOAMPE	4"	10'	Plain
PVCPPIPE4X10FOAMBE	4"	10'	Bell
PVCPPIPE6X10FOAMBE	6"	10'	Bell

CPVC Schedule 40 Pipe



. Chlorinated Polyvinyl Chloride (CPVC)

. Flow Guard Gold brand

. CTS tubing size

Part No#	Size	length	Type
CPVCPPIPE1/2X10	1/2"	10'	Plain
CPVCPPIPE3/4X10	3/4"	10'	Plain
CPVCPPIPE1X10	1"	10'	Plain

Sewer & Drain Pipe



. Tri-Wall high density three layered pipe

Part No#	Size	length	Type
PVCPPIPES&D4X10SOLID	4"	10'	Solid
PVCPPIPES&D4X10PERF	4"	10'	Perforated
PVCPPIPES&D6X10SOLID	6"	10'	Solid

PVC Schedule 30 Pipe



. Thinner PVC piping designed to fit inside a 2" x 4" wall

. To be used for drainage purposes only

Part No#	Size	length	Type
PVCPPIPE3X10THINWALL	3"	10'	Plain

Poly Water Service Pipe Coils



. CTS size tubing

. To be used instead of copper for underground water service

Part No#	Size	length	Color
POLYWATERPIPE1X100	1"	100'	Blue
POLYWATERPIPE1X300	1"	300'	Blue

PEX Pipe Straight Lengths



. Flexible piping to be used for water lines

. Strong, durable and easy installation

Part No#	Size	length	Color
PEX1/2X20WHITE	1/2"	20'	White
PEX1/2X20RED	1/2"	20'	Red
PEX1/2X20BLUE	1/2"	20'	Blue
PEX3/4X20WHITE	3/4"	20'	White
PEX3/4X20RED	3/4"	20'	Red
PEX3/4X20BLUE	3/4"	20'	Blue
PEX1X20WHITE	1"	20'	White
PEX1X20RED	1"	20'	Red
PEX1X20BLUE	1"	20'	Blue

PEX Pipe Coils



- . Flexible piping to be used for water lines
- . Strong, durable and easy installation

Part No#	Size	length	Color
PEX1/8x100WHITE	1/8" (1/4 OD)	100'	White
PEX1/4x100WHITE	1/4" (3/8 OD)	100'	White
PEX1/2X100WHITE	1/2"	100'	White
PEX1/2X100RED	1/2"	100'	Red
PEX1/2X100BLUE	1/2"	100'	Blue
PEX3/4X100WHITE	3/4"	100'	White
PEX3/4X100RED	3/4"	100'	Red
PEX3/4X100BLUE	3/4"	100'	Blue
PEX1X100WHITE	1"	100'	White
PEX1X100BLUE	1"	100'	Blue

Black Steel Pipe



- . Schedule 40 black steel threaded pipe
- . 21' lengths include thread protector

Part No#	Size	length	Type
BLKPIPE1/2X10	1/2"	10'	MPT
BLKPIPE1/2X21	1/2"	21'	MPT
BLKPIPE3/4X10	3/4"	10'	MPT
BLKPIPE3/4X21	3/4"	21'	MPT
BLKPIPE1X10	1"	10'	MPT
BLKPIPE1X21	1"	21'	MPT
BLKPIPE11/4X10	1-1/4"	10'	MPT
BLKPIPE11/4X21	1-1/4"	21'	MPT
BLKPIPE11/2X10	1-1/2"	10'	MPT
BLKPIPE11/2X21	1-1/2"	21'	MPT
BLKPIPE2X10	2"	10'	MPT
BLKPIPE2X21	2"	21'	MPT
BLKPIPE21/2X21	2-1/2"	21'	MPT
BLKPIPE3X21	3"	21'	MPT
BLKPIPE4X21	4"	21'	MPT

Galvanized Steel Pipe



- . Steel pipe dipped in protective zinc coating to prevent rust
- NOTE: DISCONTINUED ITEM. CHECK STOCK BEFORE ORDERING**

Part No#	Size	length	Type
GALVPIPE1/2X21	1/2"	21'	MPT
GALVPIPE1X21	1"	21'	MPT
GALVPIPE11/2X21	1-1/2"	21'	MPT
GALVPIPE2X21	2"	21'	MPT

Cast Iron No Hub Pipe



- . No hub cast iron pipe used for drainage only
- . Connects with rubber couplings and bands

Part No#	Size	length	Type
NHPIPE2X10	2"	10'	NH
NHPIPE3X10	3"	10'	NH
NHPIPE4X10	4"	10'	NH
NHPIPE5X10	5"	10'	NH
NHPIPE6X10	6"	10'	NH
NHPIPE8X10	8"	10'	NH

Copper Supply Pipes

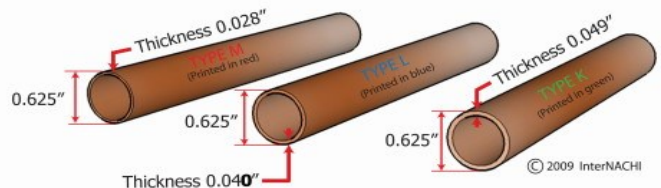

Copper DWV Pipe Lengths



- . Copper DWV pipe and fittings to be used for drainage purposes only

Part No#	Size	length	Type
COP11/2X10DWV	1-1/2"	10'	C
COP11/2X20DWV	1-1/2"	20'	C
COP2X10DWV	2"	10'	C
COP2X20DWV	2"	20'	C

Copper Pipe Type M Lengths



. Most common type of copper tubing for plumbing
 . Usually used for domestic water systems

Part No#	Size	Length	Type
COP1/2X10M	1/2"	10'	C
COP1/2X20M	1/2"	20'	C
COP3/4X10M	3/4"	10'	C
COP3/4X20M	3/4"	20'	C
COP1X10M	1"	10'	C
COP1X20M	1"	20'	C
COP11/4X10M	1-1/4"	10'	C
COP11/4X20M	1-1/4"	20'	C
COP11/2X10M	1-1/2"	10'	C
COP11/2X20M	1-1/2"	20'	C
COP2X10M	2"	10'	C
COP2X20M	2"	20'	C

Copper Pipe Type L Lengths



. Heavy duty copper typically used in domestic water systems and HVAC

Part No#	Size	Length	Type
COP1/2X10L	1/2"	10'	C
COP1/2X20L	1/2"	20'	C
COP3/4X10L	3/4"	10'	C
COP3/4X20L	3/4"	20'	C
COP1X10L	1"	10'	C
COP1X20L	1"	20'	C
COP11/4X10L	1-1/4"	10'	C
COP11/4X20L	1-1/4"	20'	C
COP11/2X10L	1-1/2"	10'	C
COP11/2X20L	1-1/2"	20'	C
COP2X10L	2"	10'	C
COP2X20L	2"	20'	C
COP21/2X10L	2-1/2"	10'	C
COP21/2X20L	2-1/2"	20'	C
COP3X10L	3"	10'	C
COP3X20L	3"	20'	C
COP4X10L	4"	10'	C
COP4X20L	4"	20'	C

Appliance Copper Coils



. Refrigeration size copper coils usually used for icemakers and appliances

Part No#	Size	Length	Type
COP1/4X50REF	1/4"	50'	C
COP3/8X50REF	3/8"	50'	C
COP1/2X50REF	1/2" OD	50'	C
COP5/8X50REF	5/8"	50'	C

Copper Type L Coils



. Heavy duty copper typically used in domestic water systems and HVAC
 . Coils usually used underground without being exposed to UV rays

Part No#	Size	Length	Type
COP1/4X60L	1/4"	60'	C
COP3/8X60L	3/8"	60'	C
COP1/2X60L	1/2"	60'	C
COP1/2X100L	1/2"	100'	C
COP3/4X60L	3/4"	60'	C
COP3/4X100L	3/4"	100'	C
COP1X60L	1"	60'	C
COP1X100L	1"	100'	C

Copper Type K Coils



. Thickest type of copper tubing
 . Usually used for underground water service applications

Part No#	Size	Length	Type
COP1/2X60K	1/2"	60'	C
COP3/4X60K	3/4"	60'	C
COP3/4X100K	3/4"	100'	C
COP1X60K	1"	60'	C
COP1X75K	1"	75'	C
COP1X100K	1"	100'	C
COP11/2X60K	1-1/2"	60'	C
COP2X40K	2"	40'	C
COP2X60K	2"	60'	C

WATER SERVICE FITTINGS/METER FITTINGS

Poly Water Service Pipe Coils



- . CTS size tubing
- . To be used instead of copper for underground water service

Part No#	Size	length	Color
POLYWATERPIPE1X100	1"	100'	Blue
POLYWATERPIPE1X300	1"	300'	Blue

Pack Joint x MPT 90 Degree Elbow

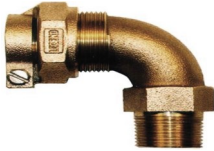

- . 90 degree elbow adapts poly water service piping to standard male pipe thread
- . Pack joint stiffener sold separately

Part No#	Size	Type
LEG1PAKJTX3/4MIPPELL	1" X 3/4"	PAKJT x MPT

Pack Joint x MPT Adapter



- . Adapts poly water service piping to standard male pipe thread
- . Pack joint stiffener sold separately

Part No#	Size	Type
LEG3/4PAKJTXMIPADAPT	3/4"	PAKJT x MPT
LEG1PAKJTXMIPADAPTER	1"	PAKJT x MPT

Pack Joint Coupling



- . Joins poly water service piping together
- . Pack joint stiffener sold separately

Part No#	Size	Type
LEG3/4PAKJTCOUPILING	3/4"	PAKJT x PAKJT
LEG1PAKJTCOUPILING	1"	PAKJT x PAKJT

Lead Service x MPT Adapter



- . Adapts lead piping to standard male pipe thread
- . Specialty fitting does not require stiffener

Part No#	Size	Type
LEG5/8LEADX3/4MIPFIT	5/8" x 3/4"	LEAD x MPT

Tracer Wire



- . 18 gauge tracer wire

Part No#	Size	Gauge
WALTRACERWIRE	4 x 500'	18

Pack Joint Stiffener Only



- . Pack joint stiffener for poly water service piping
- . Stainless Steel

Part No#	Size	Type
LEG3/4PAKSTSTIFFINER	3/4"	Stainless Steel
LEG1PAKJTSTIFFINERSS	1"	Stainless Steel

Water Meter Coupling

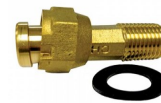

- . Adapts standard nut size on water meter to standard male pipe thread
- . Includes rubber meter gasket
- . Heavy duty brass

Part No#	Size	Type
LEG1/2METERCOUPLING	3/4" x 1/2"	FPT x MPT
LEG3/4METERCOUPLING	1" x 3/4"	FPT x MPT
LEG1METERCOUPLING	1-1/4" x 1"	FPT x MPT

Rubber Gasket For Water Meter Coupling



- . Replacement rubber gasket for water meter coupling

Part No#	Size (Nut Size)	Type
LEG1/2METERGASKET	3/4"	Rubber
LEG3/4METERGASKET	1"	Rubber
LEG1METERGASKET	1-1/4"	Rubber

Water Meter Key



- . Rebar shaft and handle for great strength
- . Vinyl covered handle for comfort

Part No#	Size	Type
PASMETERKEY	5/8" x 36"	Steel

BRASS COMPRESSION FITTINGS

Female Compression Cap



. Caps off male compression threads

Part No#	Size	Type
BRA1/4COMPCAP	1/4"	FComp
BRA3/8COMPCAP	3/8"	FComp

Female Compression Nut - Brass



. Connects male compression threads to tubing

Part No#	Size	Type
BRA1/4COMPNUIT	1/4"	FComp
BRA3/8COMPNUIT	3/8"	FComp
BRA1/2COMPNUIT	1/2"	FComp
BRA5/8COMPNUIT	5/8"	FComp
BRA7/8COMPNUIT	7/8"	FComp

Female Compression Nut - Chrome

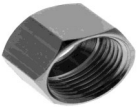

. Connects male compression threads to tubing

Part No#	Size	Type
BRA3/8COMPNUITCP	3/8"	FComp

Brass Ferrule



. Used with a nut to tighten tubing for better connection

Part No#	Size	Type
BRA1/4BRASSFERRULE	1/4"	Brass
BRA3/8BRASSFERRULE	3/8"	Brass
BRA1/2BRASSFERRULE	1/2"	Brass
BRA5/8BRASSFERRULE	5/8"	Brass
BRA7/8BRASSFERRULE	7/8"	Brass

Plastic Ferrule



. Used with a nut to tighten tubing for better connection

Part No#	Size	Type
BRA1/4POLYFERRULE	1/4"	Plastic
BRA3/8POLYFERRULE	3/8"	Plastic

Brass Stiffener For Poly Tubing



. Brass stiffener used to 1/4" OD poly tubing to strengthen pipe at connection

Part No#	Size	Type
WAL1/4STIFFENER	1/4" OD	Brass

Male Compression Union



. Connects two pieces of tubing together

Part No#	Size	Type
BRA1/4COMPUNION	1/4"	MComp x MComp
BRA3/8COMPUNION	3/8"	MComp x MComp
BRA1/2COMPUNION	1/2"	MComp x MComp
BRA5/8COMPUNION	5/8"	MComp x MComp
BRA7/8COMPUNION	7/8"	MComp x MComp
BRA3/8X1/4COMPUNION	3/8" x 1/4"	MComp x MComp
BRA1/2X3/8COMPUNION	1/2" x 3/8"	MComp x MComp
BRA5/8X3/8COMPUNION	5/8" x 3/8"	MComp x MComp
BRA5/8X1/2COMPUNION	5/8" x 1/2"	MComp x MComp

90 Degree Compression Elbow



. Connects two pieces of tubing together in an elbow

Part No#	Size	Type
BRA1/4X1/4COMPELL	1/4"	MComp x MComp
BRA3/8X3/8COMPELL	3/8"	MComp x MComp
BRA5/8X5/8COMPELL	5/8"	MComp x MComp
BRA5/8X3/8COMPELL	5/8" x 3/8"	MComp x MComp

Compression Tee



. Connects another line to an existing tubing line

Part No#	Size	Type
BRA1/4COMPTEE	1/4"	MComp
BRA3/8COMPTEE	3/8"	MComp
BRA1/2COMPTEE	1/2"	MComp
BRA5/8COMPTEE	5/8"	MComp
BRA3/8X1/4COMPTEE	3/8" x 3/8" x 1/4"	MComp

BRASS COMPRESSION FITTINGS

Male Compression x MPT Adapter



. Adapts male compression threads to standard male pipe threads

Part No#	Size	Type
BRA1/4COMPX1/8MIPAD	1/4" x 1/8"	MComp x MPT
BRA1/4COMPX1/4MIPAD	1/4" x 1/4"	MComp x MPT
BRA1/4COMPX3/8MIPAD	1/4" x 3/8"	MComp x MPT
BRA1/4COMPX1/2MIPAD	1/4" x 1/2"	MComp x MPT
BRA3/8COMPX1/4MIPAD	3/8" x 1/4"	MComp x MPT
BRA3/8COMPX3/8MIPAD	3/8" x 3/8"	MComp x MPT
BRA5/8COMPX3/8MIPAD	5/8" x 3/8"	MComp x MPT
BRA3/8COMPX1/2MIPAD	3/8" x 1/2"	MComp x MPT
BRA1/2COMPX1/2MIPAD	1/2" x 1/2"	MComp x MPT
BRA5/8COMPX1/2MIPAD	5/8" x 1/2"	MComp x MPT

Male Compression x FPT Adapter



. Adapts male compression threads to standard female pipe threads

Part No#	Size	Type
BRA1/4COMPX1/4FIPADA	1/4" x 1/4"	MComp x FPT
BRA1/4COMPX3/8FIPADA	1/4" x 3/8"	MComp x FPT
BRA1/4COMPX1/2FIPADA	1/4" x 1/2"	MComp x FPT
BRA3/8COMPX1/4FIPADA	3/8" x 1/4"	MComp x FPT
BRA3/8COMPX3/8FIPADA	3/8" x 3/8"	MComp x FPT
BRA3/8COMPX1/2FIPADA	3/8" x 1/2"	MComp x FPT
BRA1/2COMPX3/8FIPADA	1/2" x 3/8"	MComp x FPT
BRA1/2COMPX1/2FIPADA	1/2" x 1/2"	MComp x FPT
BRA5/8COMPX1/2FIPADA	5/8" x 1/2"	MComp x FPT

Male Compression x Copper Adapter



. Adapts male compression threads to copper tubing

Part No#	Size	Type
BRA14R	3/8" x 1/2"	MComp x C

90 Degree Male Compression x MPT Elbow



. Adapts male compression threads to standard male pipe threads in an elbow

Part No#	Size	Type
BRA1/4COMPX1/8MIEPELL	1/4" x 1/8"	MComp x MPT
BRA1/4COMPX1/4MIEPELL	1/4" x 1/4"	MComp x MPT
BRA1/4COMPX3/8MIEPELL	1/4" x 3/8"	MComp x MPT
BRA1/4COMPX1/2MIEPELL	1/4" x 1/2"	MComp x MPT
BRA3/8COMPX1/4MIEPELL	3/8" x 1/4"	MComp x MPT
BRA3/8COMPX3/8MIEPELL	3/8" x 3/8"	MComp x MPT
BRA3/8COMPX1/2MIEPELL	3/8" x 1/2"	MComp x MPT
BRA1/2COMPX1/2MIEPELL	1/2" x 1/2"	MComp x MPT
BRA5/8COMPX1/2MIEPELL	5/8" x 1/2"	MComp x MPT

90 Degree Male Compression x FPT Elbow



. Adapts male compression threads to standard female pipe threads in an elbow

Part No#	Size	Type
BRA3/8COMPX1/4FIEPELL	3/8" x 1/4"	MComp x FPT
BRA3/8COMPX3/8FIEPELL	3/8" x 3/8"	MComp x FPT
BRA3/8COMPX1/2FIEPELL	3/8" x 1/2"	MComp x FPT
BRA1/2COMPX1/2FIEPELL	1/2" x 1/2"	MComp x FPT
BRA5/8COMPX1/2FIEPELL	5/8" x 1/2"	MComp x FPT

GARDEN HOSE FITTINGS

Male Hose Thread x MPT Adapter



- . Adapts male hose thread to standard male pipe thread
- . Lead free

Part No#	Size	Type
PAS3/4MHTX3/4MIP	3/4" x 3/4"/1/2"	MHT x MPT/FPT
PAS3/4MHTX1/2MIP	3/4" x 1/2"	MHT x MPT

Male Hose Thread x FPT Adapter



- . Adapts male hose thread to standard female pipe thread
- . Lead free

Part No#	Size	Type
PAS3/4MHTx3/4FIP	3/4" x 3/4"	MHT x FPT

Female Hose Thread x MPT Adapter



- . Adapts female hose thread to standard male pipe thread
- . Lead free

Part No#	Size	Type
PAS3/4FHTx1/2MIP	3/4" x 1/2"	FHT x MPT

Female Hose Thread x FPT Adapter



- . Adapts female hose thread to standard female pipe thread
- . Lead free

Part No#	Size	Type
PAS3/4FHTx3/4FIP	3/4" x 3/4"	FHT x FIP
PAS3/4FHTx1/2FIP	3/4" x 1/2"	FHT x FIP

Female Hose Thread Swivel Adapter



- . Connects two male hose thread ends together
- . Lead free

Part No#	Size	Type
PAS3/4FHTX3/4FHTSWIV	3/4" x 3/4"	FHT x FHT

Female Hose Thread Cap With Washer



- . Used to cap off male hose thread

Part No#	Size	Type
PAS3/4HTCAP	3/4"	FHT

Male Hose Thread Coupling



- . Connects two female garden hose fittings together
- . Lead free

Part No#	Size	Type
PAS3/4MHTX3/4MHT	3/4" x 3/4"	MHT x MHT

Garden Hose Washer



- . Replacement rubber gasket for garden hose fittings

Part No#	Size	Type
PAS3/4RUBBERHOSEGASK	3/4"	Red Rubber

New Style Dishwasher Elbow



- . Adapts female hose thread to male compression thread
- . This fitting is most commonly used in newer style dishwashers

Part No#	Size	Type
BRAHES612X	3/4" x 3/8"	FHT x MComp

Flexible Gas Pipe Coils



- . CSA approved
- . Semi-ridged stainless steel tubing
- . Not approved for exterior use

Part No#	Size	Length
TRA1/2X50COIL	1/2"	50'
TRA1/2X100COIL	1/2"	100'
TRA1/2X250COIL	1/2"	250'
TRA3/4X100COIL	3/4"	100'
TRA3/4X250COIL	3/4"	250'
TRA1X100COIL	1"	100'
TRA1X180COIL	1"	180'
TRA11/4X150COIL	1-1/4"	150'

. Flexible gas pipe also available cut to requested length (besides 1-1/4" which is sold by the roll only). Price charged per foot. All pipe cut to size is non returnable.

TRAC Male Adapter



- . Adapts TRAC piping to standard male pipe threads
- . AutoSnap style connection

Part No#	Size	Type
TRA1/2MALEADAPT	1/2"	TRAC x MPT
TRA3/4MALEADAPT	3/4"	TRAC x MPT
TRA1MALEADAPT	1"	TRAC x MPT
TRA11/4MALEADAPT	1-1/4"	TRAC x MPT

TRAC Termination Fitting With Flange



- . TRAC termination fitting with flange
- . AutoSnap style connection

Part No#	Size	Type
TRA1/2TERMFTG/FLG	1/2"	TRAC x MPT
TRA3/4TERMFTG/FLG	3/4"	TRAC x MPT
TRA1TERMFTG/FLG	1"	TRAC x MPT
	1-1/4"	TRAC x MPT

TRAC Female Adapter



- . Adapts TRAC piping to standard female pipe threads
- . AutoSnap style connection

Part No#	Size	Type
TRA1/2FEMADAPT	1/2"	TRAC x FPT

TRAC Coupling



- . Connects two pieces of TRAC tubing
- . AutoSnap connection

Part No#	Size	Type
TRA1/2COUPLING	1/2"	TRAC
TRA3/4COUPLING	3/4"	TRAC
TRA1COUPLING	1"	TRAC
TRA11/4COUPLING	1-1/4"	TRAC

Straight Termination Fitting With Metal Base



- . TRAC termination with oversized metal base plate

Part No#	Size	Type
TRA1/2STR1PCTERMFTG	1/2"	TRAC x MPT

Angle Termination Fitting With Valve And Flange



- . TRAC termination fitting with built on gas valve

Part No#	Size	Type
TRA1/2TERMELL/FLGVAL	1/2"	TRAC

TRAC Wall Box With Gas Valve



- . TRAC wall box includes built in gas valve
- . AutoSnap connection

Part No#	Size	Type
TRA1/2WALLBOXW/FTG	1/2"	TRAC

Stub Out Bracket With Steel Flange



- . Stub out brackets for black malleable and TRAC pipe



Part No#	Size	Type
TRA1/2STUBOUTELLW/FL	1/2" Angle	MPT x MPT
TRA1/2x6STRSTUBOUT	1/2" Straight	MPT x MPT

FLEXIBLE GAS CONNECTORS/GAS FITTINGS

TRAC Fitting Tape Roll



. Protective tape for TRAC fittings and pipe

Part No#	Size	Type
TRA1/2X36FTBLKTAPERO	1" x 12 YD	Black Tape

Quick Disconnect Gas Connector Kit



. Kit includes 48" hose, quick disconnect fittings, gas valve, restraining cable and hardware, (2) 90 degree black street elbows

Part No#	Size	Size
BK3/4X48QUICKDISC	3/4" x 48"	MPT x MPT
BK1X48QUICKDISC	1" x 48"	MPT x MPT

Gas Connector Hose Only



. 48" coated stainless steel gas connector hose only

Part No#	Size	Type
BK3/4X48HOSEONLY	3/4" x 48"	MPT x MPT

Gas Appliance Connector



. 1/2" ID (5/8" OD) gas connector
 . Ideal for appliances
 . Not recommended for fireplaces

Part No#	Size	Length
BRA3/4X2GASCON	3/4" MPT/ 1/2" FPT	24"
BRA3/4X3GASCON	3/4" MPT/ 1/2" FPT	36"
BRA1/2X4GASCON	1/2" MPT/ 3/8" FPT	48"
BRA3/4X4GASCON	3/4" MPT/ 1/2" FPT	48"
BRA3/4X5GASCON	3/4" MPT/ 1/2" FPT	60"

Underground Yellow Poly Gas Pipe



. IPS size tubing
 . UV rated

Part No#	Size	Type
POLYGASPIPE3/4X150	3/4" x 150'	POLYG
POLYGASPIPE1X150	1" x 150'	POLYG
POLYGASPIPE1X300	1" x 300'	POLYG
POLYGASPIPE11/4X150	1-1/4" x 150'	POLYG

Flexible Poly Gas Pipe Riser



. Flexible stub out risers for poly gas piping
 . Adapts to standard male pipe threads

Part No#	Size	Type
POLYGASRISER3/4X36	3/4" x 36"	POLYG x MPT
POLYGASRISER1X36	1" x 36"	POLYG x MPT
POLYGASRISER11/4X36	1-1/4" x 36"	POLYG x MPT

Flexible Poly Gas Male Adapter



. Adapts poly gas pipe to standard male threads

Part No#	Size	Type
POLYGAS3/4MIPXIPSFTG	3/4"	POLYG x MPT
POLYGAS1MIPXIPSFTG	1"	POLYG x MPT
POLYGAS11/4MIPXIPSFT	1-1/4"	POLYG x MPT

Flexible Poly Gas Coupling



. Joins poly gas piping together

Part No#	Size	Type
POLYGAS3/4COUPLING	3/4"	POLYG x POLYG
POLYGAS1COUPLING	1"	POLYG x POLYG
POLYGAS11/4COUPLING	1-1/4"	POLYG x POLYG

Tracer Wire



. 18 gauge tracer wire

Part No#	Size	Gauge
WALTRACERWIRE	4 x 500'	18

BRASS FLARE FITTINGS

Flare Cap



. Used to cap off male flare thread

Part No#	Size	Type
BRA3/8FLCAP	3/8"	FFL

Flare Nut



. Connects male flare thread to soft copper tubing

Part No#	Size	Type
BRA1/4FLNUT	1/4"	FFL
BRA3/8FLNUT	3/8"	FFL
BRA1/2FLNUT	1/2" OD	FFL
BRA5/8FLNUT	5/8"	FFL
LEG3/4FLARENUT	3/4"	FFL
LEG1FLARENUT	1"	FFL
LEG11/2FLARENUT	1-1/2"	FFL

Male Flare Union Less Nuts



. Used to join two lengths of soft copper

. Flare nuts sold separately

Part No#	Size	Type
BRA1/4FLUNION	1/4"	MFL x MFL
BRA3/8FLUNION	3/8"	MFL x MFL
BRA1/2FLUNION	1/2" OD	MFL x MFL
BRA5/8FLUNION	5/8"	MFL x MFL
LEG3/4FLAREUNION	3/4"	MFL x MFL
LEG1FLAREUNION	1"	MFL x MFL
LEG11/2FLAREUNION	1-1/2"	MFL x MFL
LEG2FLAREUNION	2"	MFL x MFL
BRA1/4X3/8FLUNION	1/4" x 3/8"	MFL x MFL
BRA1/2X3/8FLUNION	1/2" OD x 3/8"	MFL x MFL
BRA5/8X1/2FLUNION	5/8" x 1/2" OD	MFL x MFL
LEG1X3/4FLAREUNION	1" x 3/4"	MFL x MFL

90 Degree Male Flare Elbow Less Nuts



. Used to change direction in a flare connection

. Flare nuts sold separately

Part No#	Size	Type
BRA3/8FLELL	3/8"	MFL x MFL
BRA1/2FLELL	1/2" OD	MFL x MFL
BRA5/8FLELL	5/8"	MFL x MFL
LEG3/4FLAREELL	3/4"	MFL x MFL
LEG1FLAREELL	1"	MFL x MFL

Male Flare Tee Less Nuts



. Used to connect a third line onto an existing line

. Flare nuts sold separately

Part No#	Size	Type
BRA1/4FLTEE	1/4"	MFL x MFL x MFL
BRA3/8FLTEE	3/8"	MFL x MFL x MFL
BRA1/2FLTEE	1/2" OD	MFL x MFL x MFL
BRA5/8FLTEE	5/8"	MFL x MFL x MFL

Male Flare x MPT Adapter



. Adapts male flare thread to stand male pipe thread

. Flare nuts sold separately

Part No#	Size	Type
BRA1/4FLX1/8MIP	1/4" x 1/8"	MFL x MPT
BRA1/4FLX1/4MIP	1/4" x 1/4"	MFL x MPT
BRA1/4FLX3/8MIP	1/4" x 3/8"	MFL x MPT
BRA1/4FLX1/2MIP	1/4" x 1/2"	MFL x MPT
BRA3/8FLX1/4MIP	3/8" x 1/4"	MFL x MPT
BRA3/8FLX3/8MIP	3/8" x 3/8"	MFL x MPT
BRA3/8FLX1/2MIP	3/8" x 1/2"	MFL x MPT
BRA1/2FLX3/8MIP	1/2" OD x 3/8"	MFL x MPT
BRA1/2FLX1/2MIP	1/2" OD x 1/2"	MFL x MPT
BRA5/8FLX1/2MIP	5/8" x 1/2"	MFL x MPT
LEG3/4FLXMIPUNION	3/4" x 3/4"	MFL x MPT
LEG1FLXMIPUNION	1" x 1"	MFL x MPT
LEG3/4X1FLXMIPUNION	3/4" x 1"	MFL x MPT
LEG11/2FLXMIPUNION	1-1/2" x 1-1/2"	MFL x MPT
LEG2FLXMIPUNION	2" x 2"	MFL x MPT

BRASS FLARE FITTINGS

Male Flare x FPT Adapter



- . Adapts male flare thread to standard female pipe thread
- . Flare nuts sold separately

Part No#	Size	Type
BRA1/4FLX3/8FIPADAPT	1/4" x 3/8"	MFL x FPT
BRA1/4FLX1/8FIPADAPT	1/4" x 1/8"	MFL x FPT
BRA1/4FLX1/2FIPADAPT	1/4" x 1/2"	MFL x FPT
BRA3/8FLX3/8FIPADAPT	3/8" x 3/8"	MFL x FPT
BRA3/8FLX1/2FIPADAPT	3/8" x 1/2"	MFL x FPT
BRA1/2FLX1/2FIPADAPT	1/2" OD x 1/2"	MFL x FPT
BRA5/8FLX1/2FIPADAPT	5/8" x 1/2"	MFL x FPT
LEG3/4FLXFIPUNION	3/4" x 3/4"	MFL x FPT
LEG1FLXFIPUNION	1" x 1"	MFL x FPT

90 Degree Male Flare x MPT Elbow



- . 90 degree elbow adapts male flare thread to standard male pipe thread
- . Flare nuts sold separately

Part No#	Size	Type
BRA1/4FLX1/8MIPELL	1/4" x 1/8"	MFL x MPT
BRA1/4FLX3/8MIPELL	1/4" x 3/8"	MFL x MPT
BRA1/4FLX1/4MIPELL	1/4" x 1/4"	MFL x MPT
BRA3/8FLX3/8MIPELL	3/8" x 3/8"	MFL x MPT
BRA3/8FLX1/2MIPELL	3/8" x 1/2"	MFL x MPT
BRA1/2FLX3/8MIPELL	1/2" OD x 3/8"	MFL x MPT
BRA1/2FLX1/2MIPELL	1/2" OD x 1/2"	MFL x MPT
BRA5/8FLX1/2MIPELL	5/8" x 1/2"	MFL x MPT
LEG3/4FLXMIPELL	3/4" x 3/4"	MFL x MPT
LEG1FLXMIPELL	1" x 1"	MFL x MPT

90 Degree Male Flare x FPT Elbow



- . 90 degree elbow adapts male flare thread to standard female pipe thread
- . Flare nuts sold separately

Part No#	Size	Type
BRA1/4FLX1/8FIPELL	1/4" x 1/8"	MFL x FPT
BRA3/8FLX3/8FIPELL	3/8" x 3/8"	MFL x FPT
BRA3/8FLX1/2FIPELL	3/8" x 1/2"	MFL x FPT
BRA1/2FLX1/2FIPELL	1/2" OD x 1/2"	MFL x FPT
BRA5/8FLX1/2FIPELL	5/8" x 1/2"	MFL x FPT

Copper Flaring Tool



- . Creates smooth flare
- . Works on sizes: 3/16", 1/4", 5/16", 3/8", 1/2" OD, 5/8"

Part No#	Size	Type
PASFLARETOOL	See Listing Above	Flare Tool

Hammer Flare Tool



- . Hammer flare tool for soft copper tubing

Part No#	Size	Type
PASFLARETOOL3/4	3/4"	Steel
PASFLARETOOL1	1"	Steel
REED11/2FLARETOOL	1-1/2"	Steel
REED2FLARETOOL	2"	Steel

BRASS PUSH FITTINGS

90 Degree Brass Push Elbow



- . Works on PEX, CPVC & copper piping
- . CTS pipe size
- . Lead free

Part No#	Size	Type
TECELL1/2	1/2"	Push x Push
TECELL3/4	3/4"	Push x Push
TECELL1	1"	Push x Push

Brass Push Tee



- . Works on PEX, CPVC & copper piping
- . CTS pipe size
- . Lead free

Part No#	Size	Type
TECTEE1/2	1/2"	Push x Push x Push
TECTEE3/4	3/4"	Push x Push x Push
TECTEE1	1"	Push x Push x Push
TECTEE3/4X1/2	3/4" x 3/4" x 1/2"	Push x Push x Push

Brass Push Male Adapter



- . Works on PEX, CPVC & copper piping
- . CTS pipe size
- . Lead Free

Part No#	Size	Type
TECMIP1/2	1/2"	Push x MPT
TECMIP3/4	3/4"	Push x MPT
TECMIP1	1"	Push x MPT

Brass Push Female Adapter



- . Works on PEX, CPVC & copper piping
- . CTS pipe size
- . Lead free

Part No#	Size	Type
TECFIP1/2	1/2"	Push x FPT

Brass Push Cap



- . Works on PEX, CPVC & copper piping
- . CTS pipe size
- . Lead free

Part No#	Size	Type
TECCAP1/2	1/2"	Push
TECCAP3/4	3/4"	Push
TECCAP1	1"	Push

Brass Push Coupling



- . Works on PEX, CPVC & copper piping
- . CTS pipe size
- . Lead free

Part No#	Size	Type
TECCOUP1/2	1/2"	Push x Push
TECCOUP3/4	3/4"	Push x Push
TECCOUP1	1"	Push x Push
TECCOUP3/4X1/2	3/4" x 1/2"	Push x Push
TECCOUP1X3/4	1" x 3/4"	Push x Push

Inserts For Brass Push Fittings



- . Replacement inserts for brass push fitting
- . Typically used for PEX piping
- . **JUST ASK! WE MAY HAVE EXTRAS IN STOCK FOR ALL SIZES!**

Insta-Loc Push Full Port Ball Valve



- . Full port lever handle
- . Works on PEX, CPVC & copper piping
- . CTS pipe size
- . Lead free

Part No#	Size	Type
LEG1/2INSTALOCBALLVA	1/2"	Push x Push
LEG3/4INSTALOCBALLVA	3/4"	Push x Push
LEG1INSTALOCBALLVALV	1"	Push x Push

Chrome Push Supply Valve



- . Chrome Finish
- . 1/4 turn
- . Works on PEX, CPVC & copper piping
- . CTS pipe size

Part No#	Size	Type
LEG1/2X3/8SBANGLESTO	1/2" Push x 3/8" Comp	Angle
LEG1/2X3/8SBSTRSTOP	1/2" Push x 3/8" Comp	Straight

PLASTIC PUSH FITTINGS

Plastic Push Tee



. Used to connect a third line onto an existing line

Part No#	Size	Type
WATPUSHTEE1/4	1/4"	Push x Push x Push
WATPUSHTEE3/8	3/8"	Push x Push x Push
WATPUSHTEE3/8X1/4	3/8" x 3/8" x 1/4"	Push x Push x Push

Plastic Push Male Adapter



. Adapts plastic push to standard male pipe thread

Part No#	Size	Type
WATPUSHMIP1/4	1/4"	Push x MPT
WATPUSHMIP3/8	3/8"	Push x MPT

Plastic Push Coupling



. Used to join lengths of plastic tubing

Part No#	Size	Type
WATPUSHCOUP1/4	1/4"	Push x Push
WATPUSHCOUP3/8	3/8"	Push x Push
WATPUSHCOUP3/8X1/4	3/8" x 1/4"	Push x Push

Plastic Push Lever Valve



. Used to join lengths of plastic tubing and provide a shut off valve

Part No#	Size	Type
WATPUSHVALVE1/4	1/4"	Push x Push
WATPUSHVALVE	3/8"	Push x Push

Standard Sink P-Trap



- . Bagged plastic tubular p-trap
- . 1 1/2 p-trap includes rubber slip joint washers and marvel fitting to connect to DWV piping coming from the wall
- . 1 1/4 and 1 1/2 x 1 1/4 p-traps includes plastic slip joint washers

Part No#	Size	Type
J&B11/4PVCBAGTRAP	1-1/4"	SJT
J&B11/2PVCBAGTRAP	1-1/2"	SJT
J&B11/2X11/4PVCBAGTR	1-1/2" x 1-1/4"	SJT

Disposal Waste Kit



- . Connects double compartment sinks with a garbage disposal to a single p-trap

Part No#	Size	Type
J&B11/2PVCDISPWASTE	1-1/2"	SJT

Center Outlet Waste Kit



- . Connects double compartments sinks to a single p-trap in the center of the sink

Part No#	Size	Type
J&B11/2PVCCOWASTE	1-1/2"	SJT

End Outlet Waste Kit



- . Connects double compartment sinks to a single p-trap on the side of the sink

Part No#	Size	Type
J&B11/2PVCEOWASTE	1-1/2"	SJT

Double Nut Extension Tailpiece



- . Connects to a single tailpiece to be used as an extension
- . Can be cut in half to be used as two single pieces

Part No#	Size	Type
J&B11/4x16PVCEXTTAIL	1-1/4" x 16"	SJT
J&B11/2x16PVCEXTTAIL	1-1/2" x 16"	SJT

Double Flanged Tailpiece



- . Connects directly to a basket strainer to extend the drain
- . To be used with a plastic flanged top hat washer
- . Can be cut in half to be used as two single pieces

Part No#	Size	Type
J&B11/2x16PVCFLGTAIL	1-1/2" x 16"	SJT

45 Degree Double Offset



- . Used to align a p-trap or tailpiece that is out of alignment
- . Can be cut in half to be used as two single pieces

Part No#	Size	Type
J&B11/2PVCDBLOFFSET	1-1/2"	SJT

Dishwasher Y-Branch Tailpiece



- . Adapts dishwasher discharge hose to tailpiece
- . 7/8 ID barb size
- . Connections include slip joint or directly to a basket strainer

Part No#	Size	Type
J&B11/2PVCYBRANCHDIR	1-1/2"	Direct Connect
J&B11/2PVCYBRANCHSJ	1-1/2"	SJT

Plastic Slip Joint Nut



- . Plastic nut for any tubular application

Part No#	Size	Type
WAL11/4POLYJAMNUT	1-1/4"	Plastic
WAL11/2POLYJAMNUT	1-1/2"	Plastic

Plastic Slip Joint Washer



- . Plastic washer for any tubular application

Part No#	Size	Type
PAS11/4POLYSJWASHER	1-1/4"	Plastic
PAS11/2POLYSJWASHER	1-1/2"	Plastic
PAS11/2X11/4POLYSJWA	1-1/2" x 1-1/4"	Plastic

Plastic Flanged Top Hat Washer



- . Connects a basket strainer or drain to a flanged tailpiece

Part No#	Size	Type
PAS11/2POLYTOPHAT	1-1/2"	Plastic

CHROME TUBULAR

Standard P-Trap With Deep Box Spinning



- . 17 gauge chrome plated
- . Includes chrome plated nuts and deep box spinning
- . Long arm design p-trap includes 15" long waste arm

Part No#	Size	Type
J&B11/4CPPTRAP	1-1/4"	SJT
J&B11/2CPPTRAP	1-1/2"	SJT

Long Arm P-Trap With Deep Box Spinning

Part No#	Size	Type
J&B11/4CPLONGPTRAP	1-1/4"	SJT
J&B11/2CPLONGPTRAP	1-1/2"	SJT

Ground Joint Style Trap



Part No#	Size	Type
J&B11/2CPGJSINKTRAP	1-1/2"	SJT

J-Bend Style Trap



Part No#	Size	Type
J&B11/2CPJBEND	1-1/2"	SJT

Disposal Waste Kit With Baffle Tee



- . Connects double compartment sinks with a garbage disposal to a single p-trap

Part No#	Size	Type
J&B11/2x13CPDISPOSAL	1-1/2"	SJT

Baffle Tee



- . Replacement baffle tee for disposal waste kit

Part No#	Size	Type
J&B11/2CPBAFFLETEE	1-1/2"	SJT

Center Outlet Waste Kit



- . Connects double compartments sinks to a single p-trap in the center of the sink

Part No#	Size	Type
J&B11/2CPCOWASTEDIR	1-1/2"	Direct Connect
J&B11/2CPCOWASTESJ	1-1/2"	SJT

Twin Elbow



- . Replacement twin elbow for center outlet waste kit

Part No#	Size	Type
J&B11/2CPBAFFLETWINE	1-1/2"	SJT

End Outlet Waste Kit



- . Connects double compartment sinks to a single p-trap on the side of the sink

Part No#	Size	Type
J&B11/2CPEOWASTEDIR	1-1/2"	Direct Connect
J&B11/2CPEOWASTESJ	1-1/2"	SJT

Chrome Solder Extensions



Part No#	Size	Type
J&B11/4x8CPSOLDERTAI	1-1/4" x 8"	SJT
J&B11/2x8CPSOLDERTAI	1-1/2" x 8"	SJT

Threaded Tube Tailpiece



Part No#	Size	Type
J&B11/4X12CPTBETAIL	1-1/4" x 12"	SJT
J&B11/2X12CPTBETAIL	1-1/2" x 12"	SJT

CHROME TUBULAR

Single Nut Extension Tube



. Connects to a single tailpiece to be used as an extension

Part No#	Size	Length
J&B11/4X8CPEXTTAIL	1-1/4" x 8"	SJT
J&B11/2X8CPEXTTAIL	1-1/2" x 8"	SJT

Double Nut Extension Tube



. Connects to a single tailpiece to be used as an extension
 . Can be cut in half to be used as two single pieces

Part No#	Size	Length
J&B11/4X16CPEXTTAIL	1-1/4" x 16"	SJT
J&B11/2X16CPEXTTAIL	1-1/2" x 16"	SJT

Double Flanged Tailpiece



. Connects directly to a basket strainer to extend the drain
 . To be used with a plastic flanged top hat washer

Part No#	Size	Length
J&B11/2X12CPFLGTAIL	1-1/2" x 12"	SJT
J&B11/2X16CPFLGTAIL	1-1/2" x 16"	SJT

45 Degree Double Offset



. Used to align a p-trap or tailpiece that is out of alignment
 . Can be cut in half to be used as two single pieces

Part No#	Size	Length
J&B11/4CPDBLOFFSET45	1-1/4"	SJT
J&B11/2CPDBLOFFSET45	1-1/2"	SJT

Dishwasher Y-Branch Tailpiece



. Adapts dishwasher discharge hose to tailpiece
 . 7/8 ID barb size

Part No#	Size	Type
J&B11/2CPYBRANCHDIR	1-1/2"	Direct Connect

Chrome Plated Jam Nut



. Chrome plated metal nut for any tubular application

Part No#	Size	Type
PAS11/4CPJAMNUT	1-1/4"	Metal
PAS11/2CPJAMNUT	1-1/2"	Metal
WAL2CPJAMNUT	2"	Metal
PAS11/2X11/4CPJAMNUT	1-1/2" x 1-1/4"	Metal

Rubber Slip Joint Washer



. Rubber washer for any tubular application

Part No#	Size	Type
PAS11/4RUBSJWASHER	1-1/4"	Rubber
PAS11/2RUBSJWASHER	1-1/2"	Rubber
PAS11/2X11/4RUBSJWAS	1-1/2" x 1-1/4"	Rubber

Rubber Mack Washer For Pop Up Assembly



. Universal to fit any standard lavatory pop

Part No#	Size	Type
SCHMACKWASH11/4	1-1/4"	Rubber

90 Degree Elbow



. Used to change direction in piping
 . May also be called a "1/4 bend"

Part No#	Size	Type
PEXELL1/2	1/2"	PEX x PEX
PEXELL3/4	3/4"	PEX x PEX
PEXELL1	1"	PEX x PEX

90 Degree MPT Elbow



. 90 degree elbow adapts PEX to standard male pipe thread

Part No#	Size	Type
PEXMIPXPEXELL1/2	1/2"	PEX x MPT
PEXMIPXPEXELL3/4	3/4"	PEX x MPT

90 Degree Reducing Elbow



. Used to change direction piping while changing size

Part No#	Size	Type
PEXELL3/4x1/2	3/4" x 1/2"	PEX x PEX

Male Adapter



. Adapts PEX to standard male pipe threads

Part No#	Size	Type
PEXXMIPADPT1/2	1/2"	PEX x MPT
PEXXMIPADPT3/4	3/4"	PEX x MPT
PEXXMIPADPT1	1"	PEX x MPT

Plug



. Used to cap off PEX piping

Part No#	Size	Type
PEXPLUG1/2	1/2"	PEX
PEXPLUG3/4	3/4"	PEX
PEXPLUG1	1"	PEX

Tee



. Used to connect a third line onto an existing line

Part No#	Size	Type
PEXTEE1/2	1/2"	PEX x PEX x PEX
PEXTEE3/4	3/4"	PEX x PEX x PEX
PEXTEE1	1"	PEX x PEX x PEX

Reducing Tee



. Used to connect a third line onto an existing line

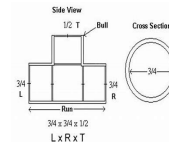

Part No#	Size	Type
PEXTEE3/4X1/2X1/2	3/4" x 1/2" x 1/2"	PEX x PEX x PEX
PEXTEE3/4X1/2X3/4	3/4" x 1/2" x 3/4"	PEX x PEX x PEX
PEXTEE3/4X1/2	3/4" x 3/4" x 1/2"	PEX x PEX x PEX
PEXTEE1/2X1/2X3/4	1/2" x 1/2" x 3/4" Bullhead	PEX x PEX x PEX
PEXTEE3/4X3/4X1	3/4" x 3/4" x 1" Bullhead	PEX x PEX x PEX
PEXTEE1X1/2	1" x 1" x 1/2"	PEX x PEX x PEX
PEXTEE1X3/4	1" x 1" x 3/4"	PEX x PEX x PEX
PEXTEE1X3/4X3/4	1" x 3/4" x 3/4"	PEX x PEX x PEX
PEXTEE1X3/4X1	1" x 3/4" x 1"	PEX x PEX x PEX

Coupling



. Used to join straight lengths of pipe together

Part No#	Size	Type
PEXCOUP1/2	1/2"	PEX x PEX
PEXCOUP3/4	3/4"	PEX x PEX
PEXCOUP1	1"	PEX x PEX

Reducing Coupling



. Used to reduce and join straight lengths of pipe together

Part No#	Size	Type
PEXCOUP3/4X1/2	3/4" x 1/2"	PEX x PEX
PEXCOUP1X1/2	1" x 1/2"	PEX x PEX
PEXCOUP1X3/4	1" x 3/4"	PEX x PEX

90 Degree PEX Wing Elbow



- . 90 degree elbow adapts PEX to standard female pipe threads
- . Includes 3 hole bracket for easy mounting
- . May also be called a "shower elbow"
- . Lead free

Part No#	Size	Type
PEXWINGELL1/2BR	1/2"	PEX x FPT
PEXWINGELL3/4BR	3/4"	PEX x FPT

Brass PEX Male Adapter



- . Adapts PEX to standard male pipe threads
- . Lead free

Part No#	Size	Type
PEXXMIPADPT1/2BR	1/2"	PEX x MPT
PEXXMIPADPT3/4BR	3/4"	PEX x MPT
PEXXMIPADPT1BR	1"	PEX x MPT
PEXXMIPADPT3/4X1BR	3/4" x 1"	PEX X MPT

Brass PEX Female Adapter



- . Adapts PEX to standard female pipe threads
- . Lead free

Part No#	Size	Type
PEXXFIPADPT1/2	1/2"	PEX x FPT
PEXXFIPADPT3/4	3/4"	PEX x FPT
PEXXFIPADPT1	1"	PEX x FPT

Copper Sweat PEX Adapter



- . Adapts PEX to copper pipe
- . Lead free

Part No#	Size	Type
PEXXCOPADPT1/2	1/2"	C x PEX
PEXXCOPADPT3/4	3/4"	C x PEX
PEXXCOPADPT1	1"	C x PEX

Copper Fitting Sweat PEX Adapter



- . Adapts PEX to a copper fitting hub
- . Lead free

Part No#	Size	Type
PEXXFTGADPT1/2	1/2"	FTG x PEX
PEXXFTGADPT3/4	3/4"	FTG x PEX
PEXXFTGADPT1	1"	PEX x FTG

PEX Tapped Wing Tee



- . Brass PEX tee with standard female pipe thread tapping
- . Includes bracket for easy mounting
- . Ideal for body sprays
- . Lead Free

Part No#	Size	Type
PEXWINGTEE1/2BR	1/2"	PEX x PEX x FPT

Copper PEX Stub Out



- . 90 degree elbow adapts copper to PEX pipe
- . Flanged style - copper flange for easy mounting

Part No#	Size	Type
SIO1/2PEXELLSTUBOUT	1/2" ANGLE - NO FLANGE	C x PEX
SIO1/2PEXELLW/FLGSO	1/2" ANGLE - FLANGED	C x PEX
SIO1/2PEXSTRSIO1/2x12	1/2" STRAIGHT - NO FLANGE	C x PEX

Copper Press x PEX Adapter



- . Adapts copper press to PEX piping
- . Lead free

Part No#	Size	Type
LEG1/2PRESSXPEXADPT	1/2"	Press x PEX
LEG3/4PRESSXPEXADPT	3/4"	Press x PEX
LEG1PRESSXPEXADPT	1"	Press x PEX

PEX Stainless Steel Crimp Rings



- . Heavy duty stainless clamp
- . To be used with specified tool for stainless rings

Part No#	Size	Material
PEXSSCRIMPCLAMPS1/2	1/2"	Stainless Steel
PEXSSCRIMPCLAMPS3/4	3/4"	Stainless Steel
PEXSSCRIMPCLAMPS1	1"	Stainless Steel

PEX Copper Crimp Rings



- . Copper solid PEX crimp ring
- . To be used with specified tool for copper rings

Part No#	Size	Material
SIOCOPPEXRING1/2	1/2"	Copper
SIOCOPPEXRING3/4	3/4"	Copper
SIOCOPPEXRING1	1"	Copper

Copper x PEX Full Port Ball Valve With Drain Port



- . Adapts copper sweat connection to PEX connection
- . Full port lever handle
- . Includes 1/8 drain port with cap
- . Lead free

Part No#	Size	Type
LEG1/2COPXPEXBALLW/D	1/2"	C x PEX
LEG3/4COPXPEXBALLW/D	3/4"	C x PEX

PEX Full Port Ball Valve



- . Full port lever handle
- . Lead free

Part No#	Size	Type
LEG1/2PEXBALLVALVE	1/2"	PEX x PEX
LEG3/4PEXBALLVALVE	3/4"	PEX x PEX
LEG1PEXBALLVALVE	1"	PEX x PEX

PEX Full Port Ball Valve With Drain Port



- . Includes 1/8 drain port with cap
- . Lead free

Part No#	Size	Type
LEG1/2PEXBALLW/DRAIN	1/2"	PEX x PEX
LEG3/4PEXBALLW/DRAIN	3/4"	PEX x PEX

PEX Full Turn Boiler Drain



- . Full turn handle
- . Lead free
- . Includes adapter for a PEX connection

Part No#	Size	Type
LEG1/2PEXBOILERDRAIN	1/2" x 3/4"	PEX x MHT

PEX Full Turn Sillcock



- . Full turn handle
- . Includes brass flange
- . Includes adapter for PEX connection
- . Lead free

Part No#	Size	Type
LEG1/2PEXSILLCOCK	1/2" x 3/4"	PEX x MHT

Legend Full Turn PEX Hose Bibb



- . Full turn handle
- . Includes built in vacuum breaker with black plastic cap
- . Includes adapter for PEX connection

Part No#	Size	Type
LEG8PEXFFSILLCOCK	1/2" x 8"	PEX x MHT
LEG10PEXFFSILLCOCK	1/2" x 10"	PEX x MHT
LEG12PEXFFSILLCOCK	1/2" x 12"	PEX x MHT

PEX Supply Valves



- . Chrome finish
- . 1/4 turn handle

Part No#	Size	Type
BRAPEX19C	1/2" PEX x 3/8" Comp	Angle
BRAPEX14C	1/2" PEX x 3/8" Comp	Straight
BRAPEX09C	1/2" PEX x 1/4" Comp	Angle

Poly Tubing Cutter



- . Includes 2-1/4 metal blade
- . Quickly cuts PEX, PVC and other poly tubing
- . Will cut up to 1-1/8 OD or smaller

Part No#	Size	Type
SIOPOLYTUBECUTTER	1-1/8" OD	Tool

PEX Cinch Clamp Tool



- . Long, easy to grip handles
- . Quick release only when ring is fully crimped
- . Works on stainless steel crimp rings only

Part No#	Size	Type
PEXCRIMPTOOLREG	3/8", 1/2", 3/4", 1"	Tool

Ratcheting PEX Cinch Clamp Tool



- . Unique design for tight spaces
- . Includes light that will light up when crimp is complete
- . Works on stainless steel crimp rings only

Part No#	Size	Type
PEXCRIMPTOOLRATCHET	3/8", 1/2", 3/4", 1"	Tool

ASK ABOUT OUR COPPER CRIMP RING SET—NOW IN STOCK!



- . Long, easy to grip handles
- . Includes convenient plastic carrying case
- . Jaws change with hex wrench
- . Works on copper crimp rings only

Part No#	Size	Type
PEXRINGCRIMPTOOL	1/2", 3/4", 1"	Tool

BLACK MALLEABLE FITTINGS

90 Degree Elbow



. Meets ASTM and ANSI standards

Part No#	Size	Type
BLKELL1/8	1/8"	FPT x FPT
BLKELL1/4	1/4"	FPT x FPT
BLKELL3/8	3/8"	FPT x FPT
BLKELL1/2	1/2"	FPT x FPT
BLKELL3/4	3/4"	FPT x FPT
BLKELL1	1"	FPT x FPT
BLKELL11/4	1-1/4"	FPT x FPT
BLKELL11/2	1-1/2"	FPT x FPT
BLKELL2	2"	FPT x FPT
BLKELL21/2	2-1/2"	FPT x FPT
BLKELL3	3"	FPT x FPT
BLKELL4	4"	FPT x FPT

90 Degree Street Elbow



. Meets ASTM and ANSI standards

Part No#	Size	Type
BLKSTELL1/8	1/8"	MPT x FPT
BLKSTELL1/4	1/4"	MPT x FPT
BLKSTELL3/8	3/8"	MPT x FPT
BLKSTELL1/2	1/2"	MPT x FPT
BLKSTELL3/4	3/4"	MPT x FPT
BLKSTELL1	1"	MPT x FPT
BLKSTELL11/4	1-1/4"	MPT x FPT
BLKSTELL11/2	1-1/2"	MPT x FPT
BLKSTELL2	2"	MPT x FPT

90 Degree Reducing Elbow



. Meets ASTM and ANSI standards

Part No#	Size	Type
BLKELL1/4X1/8	1/4" x 1/8"	FPT x FPT
BLKELL3/8X1/4	3/8" x 1/4"	FPT x FPT
BLKELL1/2X1/4	1/2" x 1/4"	FPT x FPT
BLKELL1/2X3/8	1/2" x 3/8"	FPT x FPT

90 Degree Reducing Elbow (continued)

Part No#	Size	Type
BLKELL3/4X1/2	3/4" x 1/2"	FPT x FPT
BLKELL1X1/2	1" x 1/2"	FPT x FPT
BLKELL1X3/4	1" x 3/4"	FPT x FPT
BLKELL11/4X1/2	1-1/4" x 1/2"	FPT x FPT
BLKELL11/4X3/4	1-1/4" x 3/4"	FPT x FPT
BLKELL11/4X1	1-1/4" x 1"	FPT x FPT
BLKELL11/2X1/2	1-1/2" x 1/2"	FPT x FPT
BLKELL11/2X3/4	1-1/2" x 3/4"	FPT x FPT
BLKELL11/2X1	1-1/2" x 1"	FPT x FPT
BLKELL11/2X11/4	1-1/2" x 11/4"	FPT x FPT
BLKELL2X3/4	2" x 3/4"	FPT x FPT
BLKELL2X1	2" x 1"	FPT x FPT
BLKELL2X11/4	2" x 1-1/4"	FPT x FPT
BLKELL2X11/2	2" x 1-1/2"	FPT x FPT
BLKELL21/2X11/2	2-1/2" x 1-1/2"	FPT x FPT
BLKELL21/2X2	2-1/2" x 2"	FPT x FPT
BLKELL3X2	3" x 2"	FPT x FPT
BLKELL3X21/2	3" x 2-1/2"	FPT x FPT
BLKELL4X3	4" x 3"	FPT x FPT

45 Degree Elbow



. Meets ASTM and ANSI standards

Part No#	Size	Type
BLK451/8	1/8"	FPT x FPT
BLK451/4	1/4"	FPT x FPT
BLK453/8	3/8"	FPT x FPT
BLK451/2	1/2"	FPT x FPT
BLK453/4	3/4"	FPT x FPT
BLK451	1"	FPT x FPT
BLK4511/4	1-1/4"	FPT x FPT
BLK4511/2	1-1/2"	FPT x FPT
BLK452	2"	FPT x FPT
BLK4521/2	2-1/2"	FPT x FPT
BLK453	3"	FPT x FPT
BLK454	4"	FPT x FPT

BLACK MALLEABLE FITTINGS

45 Degree Street Elbow



. Meets ASTM and ANSI standards

Part No#	Size	Type
BLKST451/8	1/8"	MPT x FPT
BLKST451/4	1/4"	MPT x FPT
BLKST453/8	3/8"	MPT x FPT
BLKST451/2	1/2"	MPT x FPT
BLKST453/4	3/4"	MPT x FPT
BLKST451	1"	MPT x FPT
BLKST4511/4	1-1/4"	MPT x FPT
BLKST4511/2	1-1/2"	MPT x FPT
BLKST452	2"	MPT x FPT

Tee



. Meets ASTM and ANSI standards

Part No#	Size	Type
BLKTEE1/8	1/8"	FPT x FPT
BLKTEE1/4	1/4"	FPT x FPT
BLKTEE3/8	3/8"	FPT x FPT
BLKTEE1/2	1/2"	FPT x FPT
BLKTEE3/4	3/4"	FPT x FPT
BLKTEE1	1"	FPT x FPT
BLKTEE11/4	1-1/4"	FPT x FPT
BLKTEE11/2	1-1/2"	FPT x FPT
BLKTEE2	2"	FPT x FPT
BLKTEE21/2	2-1/2"	FPT x FPT
BLKTEE3	3"	FPT x FPT
BLKTEE4	4"	FPT x FPT

Reducing Tee - Two Sizes



. Meets ASTM and ANSI standards

Part No#	Size	Type
BLKTEE1/2X1/4	1/2" x 1/2" x 1/4"	FPT x FPT x FPT
BLKTEE1/2X3/8	1/2" x 1/2" x 3/8"	FPT x FPT x FPT
BLKTEE3/4X1/2	3/4" x 3/4" x 1/2"	FPT x FPT x FPT
BLKTEE1X1/2	1" x 1" x 1/2"	FPT x FPT x FPT
BLKTEE1X3/4	1" x 1" x 3/4"	FPT x FPT x FPT
BLKTEE11/4X1/2	1-1/4" x 1-1/4" x 1/2"	FPT x FPT x FPT
BLKTEE11/4X3/4	1-1/4" x 1-1/4" x 3/4"	FPT x FPT x FPT
BLKTEE11/4X1	1-1/4" x 1-1/4" x 1"	FPT x FPT x FPT
BLKTEE11/2X1/2	1-1/2" x 1-1/2" x 1/2"	FPT x FPT x FPT
BLKTEE11/2X3/4	1-1/2" x 1-1/2" x 3/4"	FPT x FPT x FPT
BLKTEE11/2X1	1-1/2" x 1-1/2" x 1"	FPT x FPT x FPT
BLKTEE11/2X11/4	1-1/2" x 1-1/2" x 1-1/4"	FPT x FPT x FPT
BLKTEE2X1/2	2" x 2" x 1/2"	FPT x FPT x FPT
BLKTEE2X3/4	2" x 2" x 3/4"	FPT x FPT x FPT
BLKTEE2X1	2" x 2" x 1"	FPT x FPT x FPT
BLKTEE2X11/4	2" x 2" x 1-1/4"	FPT x FPT x FPT
BLKTEE2X11/2	2" x 2" x 1-1/2"	FPT x FPT x FPT
BLKTEE21/2X3/4	2-1/2" x 2-1/2" x 3/4"	FPT x FPT x FPT
BLKTEE21/2X1	2-1/2" x 2-1/2" x 1"	FPT x FPT x FPT
BLKTEE21/2X11/4	2-1/2" x 2-1/2" x 1-1/4"	FPT x FPT x FPT
BLKTEE21/2X11/2	2-1/2" x 2-1/2" x 1-1/2"	FPT x FPT x FPT
BLKTEE21/2X2	2-1/2" x 2-1/2" x 2"	FPT x FPT x FPT
BLKTEE3X3/4	3" x 3" x 3/4"	FPT x FPT x FPT
BLKTEE3X1	3" x 3" x 1"	FPT x FPT x FPT
BLKTEE3X11/4	3" x 3" x 1-1/4"	FPT x FPT x FPT
BLKTEE3X11/2	3" x 3" x 1-1/2"	FPT x FPT x FPT
BLKTEE3X2	3" x 3" x 2"	FPT x FPT x FPT
BLKTEE3X21/2	3" x 3" x 2-1/2"	FPT x FPT x FPT
BLKTEE4X11/2	4" x 4" x 1-1/2"	FPT x FPT x FPT
BLKTEE4X2	4" x 4" x 2"	FPT x FPT x FPT
BLKTEE4X21/2	4" x 4" x 2-1/2"	FPT x FPT x FPT
BLKTEE4X3	4" x 4" x 3"	FPT x FPT x FPT

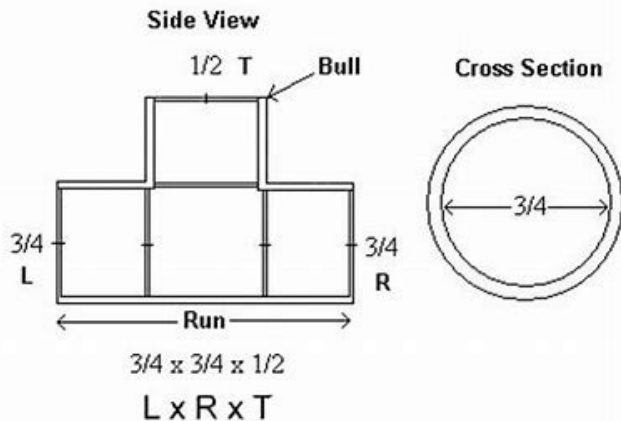

BLACK MALLEABLE FITTINGS

Reducing Tee - Three Sizes



. Meets ASTM and ANSI standards

Part No#	Size	Type
BLKTEE3/4X1/2X1/2	3/4" x 1/2" x 1/2"	FPT x FPT x FPT
BLKTEE3/4X1/2X3/4	3/4" x 1/2" x 3/4"	FPT x FPT x FPT
BLKTEE1X1/2X1/2	1" x 1/2" x 1/2"	FPT x FPT x FPT
BLKTEE1X1/2X3/4	1" x 1/2" x 3/4"	FPT x FPT x FPT
BLKTEE1X1/2X1	1" x 1/2" x 1"	FPT x FPT x FPT
BLKTEE1X3/4X1/2	1" x 3/4" x 1/2"	FPT x FPT x FPT
BLKTEE1X3/4X3/4	1" x 3/4" x 3/4"	FPT x FPT x FPT
BLKTEE1X3/4X1	1" x 3/4" x 1"	FPT x FPT x FPT
BLKTEE11/4X3/4X3/4	1-1/4" x 3/4" x 3/4"	FPT x FPT x FPT
BLKTEE11/4X3/4X1	1-1/4" x 3/4" x 1"	FPT x FPT x FPT
BLKTEE11/4X3/4X11/4	1-1/4" x 3/4" x 1-1/4"	FPT x FPT x FPT
BLKTEE11/4X1X1/2	1-1/4" x 1" x 1/2"	FPT x FPT x FPT
BLKTEE11/4X1X3/4	1-1/4" x 1" x 3/4"	FPT x FPT x FPT
BLKTEE11/4X1X1	1-1/4" x 1" x 1"	FPT x FPT x FPT
BLKTEE11/4X1X11/4	1-1/4" x 1" x 1-1/4"	FPT x FPT x FPT
BLKTEE11/2X1/2X11/2	1-1/2" x 1/2" x 1-1/2"	FPT x FPT x FPT
BLKTEE11/2X3/4X3/4	1-1/2" x 3/4" x 3/4"	FPT x FPT x FPT
BLKTEE11/2X3/4X11/2	1-1/2" x 3/4" x 1-1/2"	FPT x FPT x FPT
BLKTEE11/2X1X3/4	1-1/2" x 1" x 3/4"	FPT x FPT x FPT
BLKTEE11/2X1X1	1-1/2" x 1" x 1"	FPT x FPT x FPT
BLKTEE11/2X1X11/4	1-1/2" x 1" x 1-1/4"	FPT x FPT x FPT
BLKTEE11/2X1X11/2	1-1/2" x 1" x 1-1/2"	FPT x FPT x FPT
BLKTEE11/2x11/4x1/2	1-1/2" x 1-1/4" x 1/2"	FPT x FPT x FPT
BLKTEE11/2x11/4x3/4	1-1/2" x 1-1/4" x 3/4"	FPT x FPT x FPT
BLKTEE11/2x11/4x1	1-1/2" x 1-1/4" x 1"	FPT x FPT x FPT
BLKTEE11/2x11/4x11/4	1-1/2" x 1-1/4" x 1-1/4"	FPT x FPT x FPT
BLKTEE11/2x11/4x11/2	1-1/2" x 1-1/4" x 1-1/2"	FPT x FPT x FPT
BLKTEE2X1/2X2	2" x 1/2" x 2"	FPT x FPT x FPT
BLKTEE2X3/4X2	2" x 3/4" x 2"	FPT x FPT x FPT
BLKTEE2X1X1	2" x 1" x 1"	FPT x FPT x FPT
BLKTEE2X1X2	2" x 1" x 2"	FPT x FPT x FPT
BLKTEE2X11/4X11/4	2" x 1-1/4" x 1-1/4"	FPT x FPT x FPT
BLKTEE2X11/4X11/2	2" x 1-1/4" x 1-1/2"	FPT x FPT x FPT
BLKTEE2X11/4X2	2" x 1-1/4" x 2"	FPT x FPT x FPT
BLKTEE2X11/2X3/4	2" x 1-1/2" x 3/4"	FPT x FPT x FPT
BLKTEE2X11/2X1	2" x 1-1/2" x 1"	FPT x FPT x FPT
BLKTEE2X11/2X11/4	2" x 1-1/2" x 1-1/4"	FPT x FPT x FPT
BLKTEE2x11/2x11/2	2" x 1-1/2" x 1-1/2"	FPT x FPT x FPT
BLKTEE2X11/2X2	2" x 1-1/2" x 2"	FPT x FPT x FPT

Reducing Tee - Three Sizes (continued)

Part No#	Size	Type
BLKTEE21/2X2X2	2-1/2" x 2" x 2"	FPT x FPT x FPT
BLKTEE21/2X11/2X21/2	2-1/2" x 1-1/2" x 2-1/2"	FPT x FPT x FPT
BLKTEE21/2X2X21/2	2-1/2" x 2" x 2-1/2"	FPT x FPT x FPT
BLKTEE3X2X2	3" x 2" x 2"	FPT x FPT x FPT

Bullhead Tee



. Meets ASTM and ANSI standards

Part No#	Size	Type
BLKTEE1/2X1/2X3/4	1/2" x 1/2" x 3/4"	FPT x FPT x FPT
BLKTEE1/2X1/2X1	1/2" x 1/2" x 1"	FPT x FPT x FPT
BLKTEE3/4X3/4X1	3/4" x 3/4" x 1"	FPT x FPT x FPT
BLKTEE3/4X3/4X11/4	3/4" x 3/4" x 1-1/4"	FPT x FPT x FPT
BLKTEE1X1X11/4	1" x 1" x 1-1/4"	FPT x FPT x FPT
BLKTEE1X1X11/2	1" x 1" x 1-1/2"	FPT x FPT x FPT
BLKTEE11/4X11/4X11/2	1-1/4" x 1-1/4" x 1-1/2"	FPT x FPT x FPT
BLKTEE11/2X11/4X2	1-1/2" x 1-1/4" x 2"	FPT x FPT x FPT
BLKTEE11/2X11/2X2	1-1/2" x 1-1/2" x 2"	FPT x FPT x FPT

Cross



. Meets ASTM and ANSI standards

Part No#	Size	Type
BLKCROSS1/2	1/2"	FPT
BLKCROSS3/4	3/4"	FPT
BLKCROSS1	1"	FPT
BLKCROSS11/4	1-1/4"	FPT
BLKCROSS11/2	1-1/2"	FPT
BLKCROSS2	2"	FPT

Floor Flange



. Meets ASTM and ANSI standards

Part No#	Size	Type
BLKFLOORFLG1/2	1/2"	FPT
BLKFLOORFLG3/4	3/4"	FPT
BLKFLOORFLG1	1"	FPT
BLKFLOORFLG11/4	1-1/4"	FPT
BLKFLOORFLG11/2	1-1/2"	FPT
BLKFLOORFLG2	2"	FPT

BLACK MALLEABLE FITTINGS

Cap



. Meets ASTM and ANSI standards

Part No#	Size	Type
BLKCAP1/8	1/8"	FPT
BLKCAP1/4	1/4"	FPT
BLKCAP3/8	3/8"	FPT
BLKCAP1/2	1/2"	FPT
BLKCAP3/4	3/4"	FPT
BLKCAP1	1"	FPT
BLKCAP11/4	1-1/4"	FPT
BLKCAP11/2	1-1/2"	FPT
BLKCAP2	2"	FPT
BLKCAP21/2	2-1/2"	FPT
BLKCAP3	3"	FPT
BLKCAP4	4"	FPT

Plug



. Meets ASTM and ANSI standards

Part No#	Size	Type
BLKPLUG1/8	1/8"	MPT
BLKPLUG1/4	1/4"	MPT
BLKPLUG3/8	3/8"	MPT
BLKPLUG1/2	1/2"	MPT
BLKPLUG3/4	3/4"	MPT
BLKPLUG1	1"	MPT
BLKPLUG11/4	1-1/4"	MPT
BLKPLUG11/2	1-1/2"	MPT
BLKPLUG2	2"	MPT
BLKPLUG21/2	2-1/2"	MPT
BLKPLUG3	3"	MPT
BLKPLUG31/2	3-1/2"	MPT
BLKPLUG4	4"	MPT

Union



. Meets ASTM and ANSI standards

Part No#	Size	Type
BLKUNION1/8	1/8"	FPT x FPT
BLKUNION1/4	1/4"	FPT x FPT
BLKUNION3/8	3/8"	FPT x FPT
BLKUNION1/2	1/2"	FPT x FPT
BLKUNION3/4	3/4"	FPT x FPT
BLKUNION1	1"	FPT x FPT
BLKUNION11/4	1-1/4"	FPT x FPT
BLKUNION11/2	1-1/2"	FPT x FPT
BLKUNION2	2"	FPT x FPT
BLKUNION21/2	2-1/2"	FPT x FPT
BLKUNION3	3"	FPT x FPT
BLKUNION4	4"	FPT x FPT

Banded Coupling



. Meets ASTM and ANSI standards

Part No#	Size	Type
BLKCOUP1/8	1/8"	FPT x FPT
BLKCOUP1/4	1/4"	FPT x FPT
BLKCOUP3/8	3/8"	FPT x FPT
BLKCOUP1/2	1/2"	FPT x FPT
BLKCOUP3/4	3/4"	FPT x FPT
BLKCOUP1	1"	FPT x FPT
BLKCOUP11/4	1-1/4"	FPT x FPT
BLKCOUP11/2	1-1/2"	FPT x FPT
BLKCOUP2	2"	FPT x FPT
BLKCOUP21/2	2-1/2"	FPT x FPT
BLKCOUP3	3"	FPT x FPT
BLKCOUP4	4"	FPT x FPT

BLACK MALLEABLE FITTINGS

Reducing Coupling



. Meets ASTM and ANSI standards

Part No#	Size	Type
BLKCOUP1/4X1/8	1/4" x 1/8"	FPT x FPT
BLKCOUP3/8X1/8	3/8" x 1/8"	FPT x FPT
BLKCOUP3/8X1/4	3/8" x 1/4"	FPT x FPT
BLKCOUP1/2X1/8	1/2" x 1/8"	FPT x FPT
BLKCOUP1/2X1/4	1/2" x 1/4"	FPT x FPT
BLKCOUP1/2X3/8	1/2" x 3/8"	FPT x FPT
BLKCOUP3/4X1/4	3/4" x 1/4"	FPT x FPT
BLKCOUP3/4X3/8	3/4" x 3/8"	FPT x FPT
BLKCOUP3/4X1/2	3/4" x 1/2"	FPT x FPT
BLKCOUP1X1/2	1" x 1/2"	FPT x FPT
BLKCOUP1X3/4	1" x 3/4"	FPT x FPT
BLKCOUP11/4X1/2	1-1/4" x 1/2"	FPT x FPT
BLKCOUP11/4X3/4	1-1/4" x 3/4"	FPT x FPT
BLKCOUP11/4X1	1-1/4" x 1"	FPT x FPT
BLKCOUP11/2X1/2	1-1/2" x 1/2"	FPT x FPT
BLKCOUP11/2X3/4	1-1/2" x 3/4"	FPT x FPT
BLKCOUP11/2X1	1-1/2" x 1"	FPT x FPT
BLKCOUP11/2X11/4	1-1/2" x 1-1/4"	FPT x FPT
BLKCOUP2X1/2	2" x 1/2"	FPT x FPT
BLKCOUP2X3/4	2" x 3/4"	FPT x FPT
BLKCOUP2X1	2" x 1"	FPT x FPT
BLKCOUP2X11/4	2" x 1-1/4"	FPT x FPT
BLKCOUP2X11/2	2" x 1-1/2"	FPT x FPT
BLKCOUP21/2X1	2-1/2" x 1"	FPT x FPT
BLKCOUP21/2X11/4	2-1/2" x 1-1/4"	FPT x FPT
BLKCOUP21/2X11/2	2-1/2" x 1-1/2"	FPT x FPT
BLKCOUP21/2X2	2-1/2" x 2"	FPT x FPT
BLKCOUP3X1	3" x 1"	FPT x FPT
BLKCOUP3X11/4	3" x 1-1/4"	FPT x FPT
BLKCOUP3X11/2	3" x 1-1/2"	FPT x FPT
BLKCOUP3X2	3" x 2"	FPT x FPT
BLKCOUP3X21/2	3" x 2-1/2"	FPT x FPT
BLKCOUP4X2	4" x 2"	FPT x FPT
BLKCOUP4X3	4" x 3"	FPT x FPT
BLKCOUP6X4	6" x 4"	FPT x FPT

Reducing Bushing



. Meets ASTM and ANSI standards

Part No#	Size	Type
BLKBUSH1/4X1/8	1/4" x 1/8"	MPT x FPT
BLKBUSH3/8X1/8	3/8" x 1/8"	MPT x FPT
BLKBUSH3/8X1/4	3/8" x 1/4"	MPT x FPT
BLKBUSH1/2X1/8	1/2" x 1/8"	MPT x FPT
BLKBUSH1/2X1/4	1/2" x 1/4"	MPT x FPT
BLKBUSH1/2X3/8	1/2" x 3/8"	MPT x FPT
BLKBUSH3/4X1/4	3/4" x 1/4"	MPT x FPT
BLKBUSH3/4X3/8	3/4" x 3/8"	MPT x FPT
BLKBUSH3/4X1/2	3/4" x 1/2"	MPT x FPT
BLKBUSH1X1/4	1" x 1/4"	MPT x FPT
BLKBUSH1X3/8	1" x 3/8"	MPT x FPT
BLKBUSH1X1/2	1" x 1/2"	MPT x FPT
BLKBUSH1X3/4	1" x 3/4"	MPT x FPT
BLKBUSH11/4X1/2	1-1/4" x 1/2"	MPT x FPT
BLKBUSH11/4X3/4	1-1/4" x 3/4"	MPT x FPT
BLKBUSH11/4X1	1-1/4" x 1"	MPT x FPT
BLKBUSH11/2X1/2	1-1/2" x 1/2"	MPT x FPT
BLKBUSH11/2X3/4	1-1/2" x 3/4"	MPT x FPT
BLKBUSH11/2X1	1-1/2" x 1"	MPT x FPT
BLKBUSH11/2X11/4	1-1/2" x 11/4"	MPT x FPT
BLKBUSH2X1	2" x 1/2"	MPT x FPT
BLKBUSH2X3/4	2" x 3/4"	MPT x FPT
BLKBUSH2X1	2" x 1"	MPT x FPT
BLKBUSH2X11/4	2" x 1-1/4"	MPT x FPT
BLKBUSH2X11/2	2" x 1-1/2"	MPT x FPT
BLKBUSH21/2X3/4	2-1/2" x 3/4"	MPT x FPT
BLKBUSH21/2X1	2-1/2" x 1"	MPT x FPT
BLKBUSH21/2X11/4	2-1/2" x 1-1/4"	MPT x FPT
BLKBUSH21/2X11/2	2-1/2" x 1-1/2"	MPT x FPT
BLKBUSH21/2X2	2-1/2" x 2"	MPT x FPT
BLKBUSH3X1	3" x 1"	MPT x FPT
BLKBUSH3X11/4	3" x 1-1/4"	MPT x FPT
BLKBUSH3X11/2	3" x 1-1/2"	MPT x FPT
BLKBUSH3X2	3" x 2"	MPT x FPT
BLKBUSH3X21/2	3" x 2-1/2"	MPT x FPT

REDUCING BUSHINGS CONTINUE ON TO NEXT PAGE!

Reducing Bushing (continued)

Part No#	Size	Type
BLKBUSH31/2X3	3-1/2" x 3"	MPT x FPT
BLKBUSH4X2	4" x 2"	MPT x FPT
BLKBUSH4X21/2	4" x 2-1/2"	MPT x FPT
BLKBUSH4X3	4" x 3"	MPT x FPT
BLKBUSH6X3	6" x 3"	MPT x FPT

Black Assortment Nipple Pack

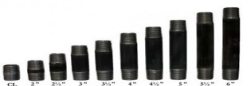

. Features nipple sizes from close - 6"
 . 66 nipples in total pack
 . Meets ASTM and ANSI standards

Part No#	Size	Type
BLKNIPPK1/2	1/2"	MPT x MPT
BLKNIPPK3/4	3/4"	MPT x MPT
BLKNIPPK1	1"	MPT x MPT

Black Precut Pipe Nipples



. Precut black pipe nipples longer than 12"
 . Meets ASTM and ANSI standards

Part No#	Size	Type
BLKNIP1/2X18	1/2" x 18"	MPT x MPT
BLKNIP1/2X24	1/2" x 24"	MPT x MPT
BLKNIP1/2X30	1/2" x 30"	MPT x MPT
BLKNIP1/2X36	1/2" x 36"	MPT x MPT
BLKNIP1/2X48	1/2" x 48"	MPT x MPT
BLKNIP1/2X60	1/2" x 60"	MPT x MPT
BLKNIP1/2X72	1/2" x 72"	MPT x MPT
BLKNIP3/4X18	3/4" x 18"	MPT x MPT
BLKNIP3/4X24	3/4" x 24"	MPT x MPT
BLKNIP3/4X30	3/4" x 30"	MPT x MPT
BLKNIP3/4X36	3/4" x 36"	MPT x MPT
BLKNIP3/4X48	3/4" x 48"	MPT x MPT
BLKNIP3/4X60	3/4" x 60"	MPT x MPT
BLKNIP1X18	1" x 18"	MPT x MPT
BLKNIP1X24	1" x 24"	MPT x MPT
BLKNIP1X30	1" x 30"	MPT x MPT
BLKNIP1X36	1" x 36"	MPT x MPT
BLKNIP1X48	1" x 48"	MPT x MPT
BLKNIP1X60	1" x 60"	MPT x MPT

Black Nipples (MPT x MPT)



. Meets ASTM and ANSI standards

Part No#	Size
BLKNIP1/8XCLOSE	1/8" x Close
BLKNIP1/8X11/2	1/8" x 1-1/2"
BLKNIP1/8X2	1/8" x 2"
BLKNIP1/8X21/2	1/8" x 2-1/2"
BLKNIP1/8X31/2	1/8" x 3-1/2"
BLKNIP1/8X6	1/8" x 6"
BLKNIP1/4XCLOSE	1/4" x Close"
BLKNIP1/4X11/2	1/4" x 1-1/2"
BLKNIP1/4X2	1/4" x 2"
BLKNIP1/4X21/2	1/4" x 2-1/2"
BLKNIP1/4X3	1/4" x 3"
BLKNIP1/4X31/2	1/4" x 3-1/2"
BLKNIP1/4X4	1/4" x 4"
BLKNIP1/4X41/2	1/4" x 4-1/2"
BLKNIP1/4X5	1/4" x 5"
BLKNIP1/4X51/2	1/4" x 5-1/2"
BLKNIP1/4X6	1/4" x 6"
BLKNIP3/8XCLOSE	3/8" x Close
BLKNIP3/8X11/2	3/8" x 1-1/2"
BLKNIP3/8X2	3/8" x 2"
BLKNIP3/8X21/2	3/8" x 2-1/2"
BLKNIP3/4X3	3/8" x 3"
BLKNIP3/8X31/2	3/8" x 3-1/2"
BLKNIP3/8X4	3/8" x 4"
BLKNIP3/8X41/2	3/8" x 4-1/2"
BLKNIP3/8X5	3/8" x 5"
BLKNIP3/8X51/2	3/8" x 5-1/2"
BLKNIP3/8X6	3/8" x 6"
BLKNIP1/2XCLOSE	1/2" x Close
BLKNIP1/2X11/2	1/2" x 1-1/2"
BLKNIP1/2X2	1/2" x 2"
BLKNIP1/2X21/2	1/2" x 2-1/2"
BLKNIP1/2X3	1/2" x 3"
BLKNIP1/2X31/2	1/2" x 3-1/2"
BLKNIP1/2X4	1/2" x 4"
BLKNIP1/2X41/2	1/2" x 4-1/2"
BLKNIP1/2X5	1/2" x 5"
BLKNIP1/2X51/2	1/2" x 5-1/2"
BLKNIP1/2X6	1/2" x 6"

BLACK NIPPLES

Nipples (MPT x MPT) (continued)

Part No#	Size	Part No#	Size	Part No#	Size
BLKNIP1/2X7	1/2" x 7"	BLKNIP11/4X31/2	1-1/4" x 3-1/2"	BLKNIP21/2X4	2-1/2" x 4"
BLKNIP1/2X8	1/2" x 8"	BLKNIP11/4X4	1-1/4" x 4"	BLKNIP21/2X41/2	2-1/2" x 4-1/2"
BLKNIP1/2X9	1/2" x 9"	BLKNIP11/4X41/2	1-1/4" x 4-1/2"	BLKNIP21/2X5	2-1/2" x 5"
BLKNIP1/2X10	1/2" x 10"	BLKNIP11/4X5	1-1/4" x 5"	BLKNIP21/2X51/2	2-1/2" x 5-1/2"
BLKNIP1/2X11	1/2" x 11"	BLKNIP11/4X51/2	1-1/4" x 5-1/2"	BLKNIP21/2X6	2-1/2" x 6"
BLKNIP1/2X12	1/2" x 12"	BLKNIP11/4X6	1-1/4" x 6"	BLKNIP21/2X8	2-1/2" x 8"
BLKNIP3/4XCLOSE	3/4" x Close	BLKNIP11/4X8	1-1/4" x 8"	BLKNIP21/2X10	2-1/2" x 10"
BLKNIP3/4X11/2	3/4" x 1-1/2"	BLKNIP11/4X10	1-1/4" x 10"	BLKNIP21/2X12	2-1/2" x 12"
BLKNIP3/4X2	3/4" x 2"	BLKNIP11/4X12	1-1/4" x 12"	BLKNIP3XCLOSE	3" x Close
BLKNIP3/4X21/2	3/4" x 2-1/2"	BLKNIP11/2XCLOSE	1-1/2" x Close	BLKNIP3X3	3" x 3"
BLKNIP3/4X3	3/4" x 3"	BLKNIP11/2X2	1-1/2" x 2"	BLKNIP3X31/2	3" x 3-1/2"
BLKNIP3/4X31/2	3/4" x 3-1/2"	BLKNIP11/2X21/2	1-1/2" x 2-1/2"	BLKNIP3X4	3" x 4"
BLKNIP3/4X4	3/4" x 4"	BLKNIP11/2X3	1-1/2" x 3"	BLKNIP3X41/2	3" x 4-1/2"
BLKNIP3/4X41/2	3/4" x 4-1/2"	BLKNIP11/2X31/2	1-1/2" x 3-1/2"	BLKNIP3X5	3" x 5"
BLKNIP3/4X5	3/4" x 5"	BLKNIP11/2X4	1-1/2" x 4"	BLKNIP3X51/2	3" x 5-1/2"
BLKNIP3/4X51/2	3/4" x 5-1/2"	BLKNIP11/2X41/2	1-1/2" x 4-1/2"	BLKNIP3X6	3" x 6"
BLKNIP3/4X6	3/4" x 6"	BLKNIP11/2X5	1-1/2" x 5"	BLKNIP3X8	3" x 8"
BLKNIP3/4X7	3/4" x 7"	BLKNIP11/2X51/2	1-1/2" x 5-1/2"	BLKNIP3X10	3" x 10"
BLKNIP3/4X8	3/4" x 8"	BLKNIP11/2X6	1-1/2" x 6"	BLKNIP3X12	3" x 12"
BLKNIP3/4X9	3/4" x 9"	BLKNIP11/2X7	1-1/2" x 7"	BLKNIP4XCLOSE	4" x Close
BLKNIP3/4X10	3/4" x 10"	BLKNIP11/2X8	1-1/2" x 8"	BLKNIP4X4	4" x 4"
BLKNIP3/4X11	3/4" x 11"	BLKNIP11/2X9	1-1/2" x 9"	BLKNIP4X41/2	4" x 4-1/2"
BLKNIP3/4X12	3/4" x 12"	BLKNIP11/2X10	1-1/2" x 10"	BLKNIP4X5	4" x 5"
BLKNIP1XCLOSE	1" x Close"	BLKNIP11/2X11	1-1/2" x 11"	BLKNIP4X51/2	4" x 5-1/2"
BLKNIP1X2	1" x 2"	BLKNIP11/2X12	1-1/2" x 12"	BLKNIP4X6	4" x 6"
BLKNIP1X21/2	1" x 2-1/2"	BLKNIP2XCLOSE	2" x Close	BLKNIP4X8	4" x 8"
BLKNIP1X3	1" x 3"	BLKNIP2X21/2	2" x 2-1/2"	BLKNIP4X10	4" x 10"
BLKNIP1X31/2	1" x 3-1/2"	BLKNIP2X3	2" x 3"	BLKNIP4X12	4" x 12"
BLKNIP1X4	1" x 4"	BLKNIP2X31/2	2" x 3-1/2"		
BLKNIP1X41/2	1" x 4-1/2"	BLKNIP2X4	2" x 4"		
BLKNIP1X5	1" x 5"	BLKNIP2X41/2	2" x 4-1/2"		
BLKNIP1X51/2	1" x 5-1/2"	BLKNIP2X5	2" x 5"		
BLKNIP1X6	1" x 6"	BLKNIP2X51/2	2" x 5-1/2"		
BLKNIP1X7	1" x 7"	BLKNIP2X6	2" x 6"		
BLKNIP1X8	1" x 8"	BLKNIP2X7	2" x 7"		
BLKNIP1X9	1" x 9"	BLKNIP2X8	2" x 8"		
BLKNIP1X10	1" x 10"	BLKNIP2X9	2" x 9"		
BLKNIP1X11	1" x 11"	BLKNIP2X10	2" x 10"		
BLKNIP1X12	1" x 12"	BLKNIP2X11	2" x 11"		
BLKNIP11/4XCLOSE	1-1/4" x Close	BLKNIP2X12	2" x 12"		
BLKNIP11/4X2	1-1/4" x 2"	BLKNIP21/2XCLOSE	2-1/2" x Close		
BLKNIP11/4X21/2	1-1/4" x 2-1/2"	BLKNIP21/2X3	2-1/2" x 3"		
BLKNIP11/4X3	1-1/4" x 3"	BLKNIP21/2X31/2	2-1/2" x 3-1/2"		

GALVANIZED MALLEABLE FITTINGS

DUE TO GALVANIZED MALLEABLE FITTINGS NOT BEING USED COMMONLY IN PLUMBING ANYMORE, MANY ITEMS MAY BE DISCONTINUED. CHECK STOCK BEFORE ORDERING.

90 Degree Elbow



. Meets ASTM and ANSI standards

Part No#	Size	Type
GALVELL1/4	1/4"	FPT x FPT
GALVELL3/8	3/8"	FPT x FPT
GALVELL1/2	1/2"	FPT x FPT
GALVELL3/4	3/4"	FPT x FPT
GALVELL1	1"	FPT x FPT
GALVELL11/4	1-1/4"	FPT x FPT
GALVELL11/2	1-1/2"	FPT x FPT
GALVELL2	2"	FPT x FPT
GALVELL21/2	2-1/2"	FPT x FPT
GALVELL3	3"	FPT x FPT
GALVELL4	4"	FPT x FPT

90 Degree Street Elbow



. Meets ASTM and ANSI standards

Part No#	Size	Type
GALVSTELL1/2	1/2"	MPT x FPT
GALVSTELL3/4	3/4"	MPT x FPT
GALVSTELL1	1"	MPT x FPT
GALVSTELL11/4	1-1/4"	MPT x FPT
GALVSTELL11/2	1-1/2"	MPT x FPT
GALVSTELL2	2"	MPT x FPT

90 Degree Reducing Elbow



. Meets ASTM and ANSI standards

Part No#	Size	Type
GALVELL3/4X1/2	3/4" x 1/2"	FPT x FPT
GALVELL1X1/2	1" x 1/2"	FPT x FPT
GALVELL1X3/4	1" x 3/4"	FPT x FPT
GALVELL11/4X3/4	1-1/4" x 3/4"	FPT x FPT
GALVELL2X3/4	2" x 3/4"	FPT x FPT
GALVELL2X11/2	2" x 1-1/2"	FPT x FPT
GALVELL21/2X11/2	2-1/2" x 1-1/2"	FPT x FPT

45 Degree Elbow



. Meets ASTM and ANSI standards

Part No#	Size	Type
GALV451/8	1/8"	FPT x FPT
GALV451/4	1/4"	FPT x FPT
GALV453/8	3/8"	FPT x FPT
GALV451/2	1/2"	FPT x FPT
GALV453/4	3/4"	FPT x FPT
GALV451	1"	FPT x FPT
GALV4511/4	1-1/4"	FPT x FPT
GALV4511/2	1-1/2"	FPT x FPT
GALV452	2"	FPT x FPT

45 Degree Street Elbow



. Meets ASTM and ANSI standards

Part No#	Size	Type
GALVST451/2	1/2"	MPT x FPT
GALVST453/4	3/4"	MPT x FPT
GALVST4511/4	1-1/4"	MPT x FPT

Tee



. Meets ASTM and ANSI standards

Part No#	Size	Type
GALVTEE1/8	1/8"	FPT x FPT x FPT
GALVTEE1/4	1/4"	FPT x FPT x FPT
GALVTEE3/8	3/8"	FPT x FPT x FPT
GALVTEE1/2	1/2"	FPT x FPT x FPT
GALVTEE3/4	3/4"	FPT x FPT x FPT
GALVTEE1	1"	FPT x FPT x FPT
GALVTEE11/4	1-1/4"	FPT x FPT x FPT
GALVTEE11/2	1-1/2"	FPT x FPT x FPT
GALVTEE2	2"	FPT x FPT x FPT
GALVTEE21/2	2-1/2"	FPT x FPT x FPT
GALVTEE3	3"	FPT x FPT x FPT
GALVTEE4	4"	FPT x FPT x FPT

GALVANIZED MALLEABLE FITTINGS

Reducing Tee



. Meets ASTM and ANSI standards

Part No#	Size	Type
GALVTEE3/4X1/2X1/2	3/4" x 1/2" x 1/2"	FPT x FPT x FPT
GALVTEE3/4X1/2X3/4	3/4" x 1/2" x 3/4"	FPT x FPT x FPT
GALVTEE3/4X1/2	3/4" x 3/4" x 1/2"	FPT x FPT x FPT
GALVTEE1X1/2	1" x 1" x 1/2"	FPT x FPT x FPT
GALVTEE1X3/4	1" x 1" x 3/4"	FPT x FPT x FPT
GALVTEE11/4X3/4	1-1/4" x 1-1/4" x 3/4"	FPT x FPT x FPT
GALVTEE11/4X1	1-1/4" x 1-1/4" x 1"	FPT x FPT x FPT
GALVTEE11/2X1/2	1-1/2" x 1-1/2" x 1/2"	FPT x FPT x FPT
GALVTEE11/2X3/4	1-1/2" x 1-1/2" x 3/4"	FPT x FPT x FPT
GALVTEE11/2X1	1-1/2" x 1-1/2" x 1"	FPT x FPT x FPT
GALVTEE11/2X11/4	1-1/2" x 1-1/2" x 1-1/4"	FPT x FPT x FPT
GALVTEE2X1	2" x 2" x 1"	FPT x FPT x FPT
GALVTEE2X11/4	2" x 2" x 1-1/4"	FPT x FPT x FPT
GALVTEE2X11/2	2" x 2" x 1-1/2"	FPT x FPT x FPT
GALVTEE2X11/4X11/2	2" x 1-1/4" x 1-1/2"	FPT x FPT x FPT

Cap



. Meets ASTM and ANSI standards

Part No#	Size	Type
GALVCAP1/4	1/4"	FPT
GALVCAP3/8	3/8"	FPT
GALVCAP1/2	1/2"	FPT
GALVCAP3/4	3/4"	FPT
GALVCAP1	1"	FPT
GALVCAP11/4	1-1/4"	FPT
GALVCAP11/2	1-1/2"	FPT
GALVCAP2	2"	FPT
GALVCAP21/2	2-1/2"	FPT
GALVCAP3	3"	FPT
GALVCAP4	4"	FPT

Plug



. Meets ASTM and ANSI standards

Part No#	Size	Type
GALVPLUG1/8	1/8"	FPT
GALVPLUG1/4	1/4"	FPT
GALVPLUG3/8	3/8"	FPT
GALVPLUG1/2	1/2"	FPT
GALVPLUG3/4	3/4"	FPT
GALVPLUG1	1"	FPT
GALVPLUG11/4	1-1/4"	FPT
GALVPLUG11/2	1-1/2"	FPT
GALVPLUG2	2"	FPT
GALVPLUG21/2	2-1/2"	FPT
GALVPLUG3	3"	FPT
GALVPLUG4	4"	FPT

Union



. Meets ASTM and ANSI standards

Part No#	Size	Type
GALVUNION1/8	1/8"	FPT x FPT
GALVUNION1/4	1/4"	FPT x FPT
GALVUNION3/8	3/8"	FPT x FPT
GALVUNION1/2	1/2"	FPT x FPT
GALVUNION3/4	3/4"	FPT x FPT
GALVUNION1	1"	FPT x FPT
GALVUNION11/4	1-1/4"	FPT x FPT
GALVUNION11/2	1-1/2"	FPT x FPT
GALVUNION2	2"	FPT x FPT
GALVUNION21/2	2-1/2"	FPT x FPT
GALVUNION3	3"	FPT x FPT

GALVANIZED MALLEABLE FITTINGS & NIPPLES

Banded Coupling



. Meets ASTM and ANSI standards

Part No#	Size	Type
GALVCOUP1/8	1/8"	FPT x FPT
GALVCOUP1/4	1/4"	FPT x FPT
GALVCOUP3/8	3/8"	FPT x FPT
GALVCOUP1/2	1/2"	FPT x FPT
GALVCOUP3/4	3/4"	FPT x FPT
GALVCOUP1	1"	FPT x FPT
GALVCOUP11/4	1-1/4"	FPT x FPT
GALVCOUP11/2	1-1/2"	FPT x FPT
GALVCOUP2	2"	FPT x FPT
GALVCOUP21/2	2-1/2"	FPT x FPT
GALVCOUP3	3"	FPT x FPT
GALVCOUP4	4"	FPT x FPT

Reducing Coupling



. Meets ASTM and ANSI standards

Part No#	Size	Type
GALVCOUP3/8X1/4	3/8" x 1/4"	FPT x FPT
GALVCOUP1/4X1/8	1/4" x 1/8"	FPT x FPT
GALVCOUP3/8X1/8	3/8" x 1/8"	FPT x FPT
GALVCOUP1/2X1/4	1/2" x 1/4"	FPT x FPT
GALVCOUP1/2X3/8	1/2" x 3/8"	FPT x FPT
GALVCOUP3/4X1/2	3/4" x 1/2"	FPT x FPT
GALVCOUP1X1/2	1" x 1/2"	FPT x FPT
GALVCOUP1X3/4	1" x 3/4"	FPT x FPT
GALVCOUP11/4X3/4	1-1/4" x 3/4"	FPT x FPT
GALVCOUP11/4X1	1-1/4" x 1"	FPT x FPT
GALVCOUP11/2X3/4	1-1/2" x 3/4"	FPT x FPT
GALVCOUP11/2X1	1-1/2" x 1"	FPT x FPT
GALVCOUP11/2X11/4	1-1/2" x 1-1/4"	FPT x FPT
GALVCOUP2X3/4	2" x 3/4"	FPT x FPT
GALVCOUP2X1	2" x 1"	FPT x FPT
GALVCOUP2X11/4	2" x 1-1/4"	FPT x FPT
GALVCOUP2X11/2	2" x 1-1/2"	FPT x FPT
GALVCOUP21/2X2	2-1/2" x 2"	FPT x FPT
GALVCOUP3X11/2	3" x 1-1/2"	FPT x FPT
GALVCOUP3X2	3" x 2"	FPT x FPT
GALVCOUP3X21/2	3" x 2-1/2"	FPT x FPT
GALVCOUP4X3	4" x 3"	FPT x FPT

Reducing Bushing



. Meets ASTM and ANSI standards

Part No#	Size	Type
GALVBUSH3/8X1/4	3/8" x 1/4"	MPT x FPT
GALVBUSH1/2X1/8	1/2" x 1/8"	MPT x FPT
GALVBUSH1/2X1/4	1/2" x 1/4"	MPT x FPT
GALVBUSH1/2X3/8	1/2" x 3/8"	MPT x FPT
GALVBUSH3/4X1/2	3/4" x 1/2"	MPT x FPT
GALVBUSH1X1/2	1" x 1/2"	MPT x FPT
GALVBUSH1X3/4	1" x 3/4"	MPT x FPT
GALVBUSH11/4X1/2	1-1/4" x 1/2"	MPT x FPT
GALVBUSH11/4X3/4	1-1/4" x 3/4"	MPT x FPT
GALVBUSH11/4X1	1-1/4" x 1"	MPT x FPT
GALVBUSH11/2X1/2	1-1/2" x 1/2"	MPT x FPT
GALVBUSH11/2X3/4	1-1/2" x 3/4"	MPT x FPT
GALVBUSH11/2X1	1-1/2" x 1"	MPT x FPT
GALVBUSH11/2X11/4	1-1/2" x 1-1/4"	MPT x FPT
GALVBUSH2X1/2	2" x 1/2"	MPT x FPT
GALVBUSH2X3/4	2" x 3/4"	MPT x FPT
GALVBUSH2X1	2" x 1"	MPT x FPT
GALVBUSH2X11/4	2" x 1-1/4"	MPT x FPT
GALVBUSH2X11/2	2" x 1-1/2"	MPT x FPT
GALVBUSH21/2X11/2	2-1/2" x 1-1/2"	MPT x FPT
GALVBUSH21/2X2	2-1/2" x 2"	MPT x FPT
GALVBUSH3X11/2	3" x 1-1/2"	MPT x FPT
GALVBUSH3X2	3" x 2"	MPT x FPT
GALVBUSH3X21/2	3" x 2-1/2"	MPT x FPT
GALVBUSH31/2X21/2	3-1/2" x 2-1/2"	MPT x FPT
GALVBUSH4X3	4" x 3"	MPT x FPT

Galvanized Nipple Assortment Pack



. Features nipple sizes from close—6"

. 66 nipples in total pack

. Meets ASTM and ANSI standards

Part No#	Size	Type
GALVNIPPK1/2	1/2"	MPT x MPT
GALVNIPPK3/4	3/4"	MPT x MPT
GALVNIPPK1	1"	MPT x MPT

GALVANIZED NIPPLES

Nipples (MPT x MPT)



. Meets ASTM and ANSI standards

Part No#	Size	Part No#	Size
		GALVNIP1/2X12	1/2" x 12"
		GALVNIP3/4XCLOSE	3/4" x Close
		GALVNIP3/4X11/2	3/4" x 1-1/2"
		GALVNIP3/4X2	3/4" x 2"
		GALVNIP3/4X21/2	3/4" x 2-1/2"
		GALVNIP3/4X3	3/4" x 3"
		GALVNIP3/4X31/2	3/4" x 3-1/2"
		GALVNIP3/4X4	3/4" x 4"
		GALVNIP3/4X41/2	3/4" x 4-1/2"
		GALVNIP3/4X5	3/4" x 5"
		GALVNIP3/4X51/2	3/4" x 5-1/2"
		GALVNIP3/4X6	3/4" x 6"
		GALVNIP3/4X6	3/4" x 7"
		GALVNIP3/4X8	3/4" x 8"
		GALVNIP3/4X9	3/4" x 9"
		GALVNIP3/4X10	3/4" x 10"
		GALVNIP3/4X11	3/4" x 11"
		GALVNIP3/4X12	3/4" x 12"
		GALVNIP1XCLOSE	1" x Close
		GALVNIP1X2	1" x 2"
		GALVNIP1X21/2	1" x 2-1/2"
		GALVNIP1X3	1" x 3"
		GALVNIP1X31/2	1" x 3-1/2"
		GALVNIP1X4	1" x 4"
		GALVNIP1X41/2	1" x 4-1/2"
		GALVNIP1X5	1" x 5"
		GALVNIP1X51/2	1" x 5-1/2"
		GALVNIP1X6	1" x 6"
		GALVNIP11/4XCLOSE	1-1/4" x Close
		GALVNIP11/4X2	1-1/4" x 2"
		GALVNIP11/4X21/2	1-1/4" x 2-1/2"
		GALVNIP11/4X3	1-1/4" x 3"
		GALVNIP11/4X31/2	1-1/4" x 3-1/2"
		GALVNIP11/4X4	1-1/4" x 4"
		GALVNIP11/4X41/2	1-1/4" x 4-1/2"
		GALVNIP11/4X5	1-1/4" x 5"
		GALVNIP11/4X51/2	1-1/4" x 5-1/2"
		GALVNIP11/4X6	1-1/4" x 6"
		GALVNIP11/2XCLOSE	1-1/2" x Close
		GALVNIP11/2X2	1-1/2" x 2"
		GALVNIP11/2X21/2	1-1/2" x 2-1/2"
		GALVNIP11/2X3	1-1/2" x 3"
		GALVNIP11/2X31/2	1-1/2" x 3-1/2"
		GALVNIP11/2X4	1-1/2" x 4"
		GALVNIP11/2X41/2	1-1/2" x 4-1/2"
		GALVNIP11/2X5	1-1/2" x 5"
		GALVNIP11/2X51/2	1-1/2" x 5-1/2"
		GALVNIP11/2X6	1-1/2" x 6"
		GALVNIP11/2X7	1-1/2" x 7"
		GALVNIP11/2X8	1-1/2" x 8"
		GALVNIP11/2X9	1-1/2" x 9"
		GALVNIP11/2X10	1-1/2" x 10"
		GALVNIP11/2X11	1-1/2" x 11"
		GALVNIP11/2X12	1-1/2" x 12"
		GALVNIP11/2X4	1-1/2" x 4"
		GALVNIP11/2X41/2	1-1/2" x 4-1/2"
		GALVNIP11/2X5	1-1/2" x 5"
		GALVNIP11/2X51/2	1-1/2" x 5-1/2"
		GALVNIP11/2X6	1-1/2" x 6"
		GALVNIP2XCLOSE	2" x Close
		GALVNIP2X21/2	2" x 2-1/2"
		GALVNIP2X3	2" x 3"
		GALVNIP2X31/2	2" x 3-1/2"
		GALVNIP2X4	2" x 4"
		GALVNIP2X41/2	2" x 4-1/2"
		GALVNIP2X5	2" x 5"
		GALVNIP2X51/2	2" x 5-1/2"
		GALVNIP21/2X3	2-1/2" x 3"
		GALVNIP21/2X31/2	2-1/2" x 3-1/2"
		GALVNIP21/2X4	2-1/2" x 4"
		GALVNIP21/2X41/2	2-1/2" x 4-1/2"
		GALVNIP21/2X5	2-1/2" x 5"
		GALVNIP21/2X51/2	2-1/2" x 5-1/2"
		GALVNIP21/2X6	2-1/2" x 6"
		GALVNIP3XCLOSE	3" x Close
		GALVNIP3X3	3" x 3"
		GALVNIP3X31/2	3" x 3-1/2"
		GALVNIP3X4	3" x 4"
		GALVNIP3X41/2	3" x 4-1/2"
		GALVNIP3X5	3" x 5"
		GALVNIP3X51/2	3" x 5-1/2"
		GALVNIP3X6	3" x 6"
		GALVNIP4XCLOSE	4" x Close
		GALVNIP4X4	4" x 4"
		GALVNIP4X41/2	4" x 4-1/2"
		GALVNIP4X5	4" x 5"
		GALVNIP4X51/2	4" x 5-1/2"
		GALVNIP4X6	4" x 6"

CHROME PLATED FITTINGS

90 Degree Elbow



. Lead free

Part No#	Size	Type
CHRELL3/8	3/8"	FPT x FPT
CHRELL1/2	1/2"	FPT x FPT
CHRELL3/4	3/4"	FPT x FPT
CHRELL1	1"	FPT x FPT

45 Degree Elbow



. Lead free

Part No#	Size	Type
CHR451/2	1/2"	FPT x FPT
CHR453/4	3/4"	FPT x FPT

Tee



. Lead free

Part No#	Size	Type
CHRTEE1/2	1/2"	FPT x FPT x FPT

Union



. Lead Free

Part No#	Size	Type
CHRUNION1/2	1/2"	FPT x FPT

Coupling



. Lead Free

Part No#	Size	Type
CHRCOUP3/8	3/8"	FPT x FPT
CHRCOUP1/2	1/2"	FPT x FPT
CHRCOUP3/4	3/4"	FPT x FPT
CHRCOUP1	1"	FPT x FPT

Nipples (MPT x MPT)



. Lead Free

Part No#	Size	Type
CHRNIP3/8XCLOSE	3/8" x Close	MPT x MPT
CHRNIP3/8X11/2	3/8" x 1-1/2"	MPT x MPT
CHRNIP3/8X2	3/8" x 2"	MPT x MPT
CHRNIP3/8X21/2	3/8" x 2-1/2"	MPT x MPT
CHRNIP3/8X3	3/8" x 3"	MPT x MPT
CHRNIP3/8X31/2	3/8" x 3-1/2"	MPT x MPT
CHRNIP3/8X4	3/8" x 4"	MPT x MPT
CHRNIP3/8X41/2	3/8" x 4-1/2"	MPT x MPT
CHRNIP3/8X5	3/8" x 5"	MPT x MPT
CHRNIP3/8X51/2	3/8" x 5-1/2"	MPT x MPT
CHRNIP3/8X6	3/8" x 6"	MPT x MPT
CHRNIP1/2XCLOSE	1/2" x Close	MPT x MPT
CHRNIP1/2X11/2	1/2" x 1-1/2"	MPT x MPT
CHRNIP1/2X2	1/2" x 2"	MPT x MPT
CHRNIP1/2X21/2	1/2" x 2-1/2"	MPT x MPT
CHRNIP1/2X3	1/2" x 3"	MPT x MPT
CHRNIP1/2X31/2	1/2" x 3-1/2"	MPT x MPT
CHRNIP1/2X4	1/2" x 4"	MPT x MPT
CHRNIP1/2X41/2	1/2" x 4-1/2"	MPT x MPT
CHRNIP1/2X5	1/2" x 5"	MPT x MPT
CHRNIP1/2X51/2	1/2" x 5-1/2"	MPT x MPT
CHRNIP1/2X6	1/2" x 6"	MPT x MPT

LOOKING FOR 3/4" CHROME PLATED NIPPLES? GIVE US A CALL! WE MAY STILL HAVE IT!

BRASS FITTINGS

90 Degree Elbow



. Lead free

Part No#	Size	Type
BRASELL1/8	1/8"	FPT x FPT
BRASELL1/4	1/4"	FPT x FPT
BRASELL3/8	3/8"	FPT x FPT
BRASELL1/2	1/2"	FPT x FPT
BRASELL3/4	3/4"	FPT x FPT
BRASELL1	1"	FPT x FPT
BRASELL11/4	1-1/4"	FPT x FPT
BRASELL11/2	1-1/2"	FPT x FPT
BRASELL2	2"	FPT x FPT
BRASELL3/4X1/2	3/4" X 1/2"	FPT x FPT

90 Degree Street Elbow



. Lead free

Part No#	Size	Type
BRASSSTELL1/8	1/8"	MPT x FPT
BRASSSTELL1/4	1/4"	MPT x FPT
BRASSSTELL3/8	3/8"	MPT x FPT
BRASSSTELL1/2	1/2"	MPT x FPT
BRASSSTELL3/4	3/4"	MPT x FPT
BRASSSTELL1	1"	MPT x FPT

45 Degree Elbow



. Lead free

Part No#	Size	Type
BRASS451/4	1/4"	FPT x FPT
BRASS453/8	3/8"	FPT x FPT
BRASS451/2	1/2"	FPT x FPT
BRASS453/4	3/4"	FPT x FPT

Tee



. Lead free

Part No#	Size	Type
BRASSTEE1/8	1/8"	FPT x FPT x FPT
BRASSTEE1/4	1/4"	FPT x FPT x FPT
BRASSTEE3/8	3/8"	FPT x FPT x FPT
BRASSTEE1/2	1/2"	FPT x FPT x FPT
BRASSTEE3/4	3/4"	FPT x FPT x FPT
BRASSTEE1	1"	FPT x FPT x FPT
BRASSTEE11/4	1-1/4"	FPT x FPT x FPT
BRASSTEE11/2	1-1/2"	FPT x FPT x FPT
BRASSTEE2	2"	FPT x FPT x FPT
BRASSTEE3/4X1/2	3/4" X 3/4" X 1/2"	FPT x FPT x FPT

Cap



. Lead free

Part No#	Size	Type
BRASSCAP1/8	1/8"	FPT
BRASSCAP1/4	1/4"	FPT
BRASSCAP3/8	3/8"	FPT
BRASSCAP1/2	1/2"	FPT
BRASSCAP3/4	3/4"	FPT
BRASSCAP1	1"	FPT
BRASSCAP11/4	1-1/4"	FPT
BRASSCAP11/2	1-1/2"	FPT
BRASSCAP2	2"	FPT

BRASS FITTINGS

Plug



. Lead free

Part No#	Size	Type
BRASSPLUG1/8	1/8"	MPT
BRASSPLUG1/4	1/4"	MPT
BRASSPLUG3/8	3/8"	MPT
BRASSPLUG1/2	1/2"	MPT
BRASSPLUG3/4	3/4"	MPT
BRASSPLUG1	1"	MPT
BRASSPLUG11/4	1-1/4"	MPT
BRASSPLUG11/2	1-1/2"	MPT
BRASSPLUG2	2"	MPT

Cleanout Style Raised Head Plug



. Less threads for a cleanout fitting
. Extended raised head

Part No#	Size	Type
LEG11/2RHBRASS/OPLU	1-1/2"	MPT
LEG2RHBRASS/OPLUG	2"	MPT
LEG21/2RHBRASS/OPLU	2-1/2"	MPT
LEG3RHBRASS/OPLUG	3"	MPT
LEG31/2RHBRASS/OPLU	3-1/2"	MPT
LEG4RHBRASS/OPLUG	4"	MPT
LEG5RHBRASS/OPLUG	5"	MPT
LEG6RHBRASS/OPLUG	6"	MPT
LEG8RHBRASS/OPLUG	8"	MPT

Cleanout Style Flush Plug

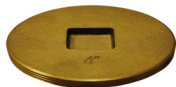

. Less threads for a cleanout fitting
. Flush countersunk head

Part No#	Size	Type
LEG11/2CSBRASS/OPLU	1-1/2"	MPT
LEG2CSBRASS/OPLUG	2"	MPT
LEG21/2BRASS/OPLUG	2-1/2"	MPT
LEG3CSBRASS/OPLUG	3"	MPT
LEG31/2CSBRASS/OPLU	3-1/2"	MPT
LEG4CSBRASS/OPLUG	4"	MPT
LEG5CSBRASS/OPLUG	5"	MPT
LEG6CSBRASS/OPLUG	6"	MPT
LEG8C/SBRASS/OPLUG	8"	MPT

Brass Male Trap Adapter



. Adapts male pipe thread or copper fitting to slip joint tubular
. May also be called a "male marvel"

Part No#	Size	Type
LEG11/4BRMIPMARVEL	1-1/4"	H/MPT x SJT
LEG11/2BRMIPMARVEL	1-1/2"	H/MPT x SJT
LEG11/2X11/4BRMIPMAR	1-1/2" x 1-1/4"	H/MPT x SJT

Brass Female Trap Adapter



. Adapts Female pipe thread to slip joint tubular
. May also be called a "female marvel"

Part No#	Size	Type
LEG11/4BRFIPMARVEL	1-1/4"	FPT x SJT
LEG11/2BRFEMMARVEL	1-1/2"	FPT x SJT
LEG11/2X11/4BRFEMMAR	1-1/2" x 1-1/4"	FPT x SJT

Union



. Lead free

Part No#	Size	Type
BRASSUNION1/2	1/2"	FPT x FPT
BRASSUNION3/4	3/4"	FPT x FPT
BRASSUNION1	1"	FPT x FPT
BRASSUNION11/4	1-1/4"	FPT x FPT
BRASSUNION11/2	1-1/2"	FPT x FPT
BRASSUNION2	2"	FPT x FPT

Coupling



. Lead free

Part No#	Size	Type
BRASSCOUP1/4	1/4"	FPT x FPT
BRASSCOUP3/8	3/8"	FPT x FPT
BRASSCOUP1/2	1/2"	FPT x FPT
BRASSCOUP3/4	3/4"	FPT x FPT
BRASSCOUP1	1"	FPT x FPT
BRASSCOUP11/4	1-1/4"	FPT x FPT
BRASSCOUP11/2	1-1/2"	FPT x FPT
BRASSCOUP2	2"	FPT x FPT

BRASS FITTINGS

Reducing Coupling



. Lead Free

Part No#	Size	Type
BRASSCOUP1/2X1/4	1/2" x 1/4"	FPT x FPT
BRASSCOUP1/2X3/8	1/2" x 3/8"	FPT x FPT
BRASSCOUP3/4X1/2	3/4" x 1/2"	FPT x FPT
BRASSCOUP1X1/2	1" x 1/2"	FPT x FPT
BRASSCOUP1X3/4	1" x 3/4"	FPT x FPT
BRASSCOUP11/2X11/4	1-1/2" x 1-1/4"	FPT x FPT
BRASSCOUP2X11/2	2" x 1-1/2"	FPT x FPT

Flush Reducing Bushing



. Lead Free

Part No#	Size	Type
BRASSFLBUSH3/4X1/2	3/4" x 1/2"	MPT x FPT

Reducing Bushing



. Lead Free

Part No#	Size	Type
BRASSBUSH1/4X1/8	1/4" x 1/8"	MPT x FPT
BRASSBUSH3/8X1/8	3/8" x 1/8"	MPT x FPT
BRASSBUSH3/8X1/4	3/8" x 1/4"	MPT x FPT
BRASSBUSH1/2X1/8	1/2" x 1/8"	MPT x FPT
BRASSBUSH1/2X1/4	1/2" x 1/4"	MPT x FPT
BRASSBUSH1/2X3/8	1/2" x 3/8"	MPT x FPT
BRASSBUSH3/4X1/8	3/4" x 1/8"	MPT x FPT
BRASSBUSH3/4X1/4	3/4" x 1/4"	MPT x FPT
BRASSBUSH3/4x3/8	3/4" x 3/8"	MPT x FPT
BRASSBUSH3/4X1/2	3/4" x 1/2"	MPT x FPT
BRASSBUSH1X1/2	1" x 1/2"	MPT x FPT
BRASSBUSH1X3/4	1" x 3/4"	MPT x FPT
BRASSBUSH11/4X1/2	1-1/4" x 1/2"	MPT x FPT
BRASSBUSH11/4X3/4	1-1/4" x 3/4"	MPT x FPT
BRASSBUSH11/4X1	1-1/4" x 1"	MPT x FPT
BRASSBUSH11/2X1/2	1-1/2" x 1/2"	MPT x FPT
BRASSBUSH11/2X3/4	1-1/2" x 3/4"	MPT x FPT
BRASSBUSH11/2X1	1-1/2" x 1"	MPT x FPT
BRASSBUSH11/2X11/4	1-1/2" x 1-1/4"	MPT x FPT
BRASSBUSH2X3/4	2" x 3/4"	MPT x FPT
BRASSBUSH2X1	2" x 1"	MPT x FPT
BRASSBUSH2X11/4	2" x 1-1/4"	MPT x FPT
BRASSBUSH2X11/2	2" x 1-1/2"	MPT x FPT
BRASSBUSH21/2X2	2-1/2" x 2"	MPT x FPT
BRASSBUSH3X2	3" x 2"	MPT x FPT

BRASS NIPPLES

Nipples (MPT x MPT)



. Lead free

Part No#	Size	Part No#	Size	Part No#	Size
		BRASSNIP3/4X11/2	3/4" x 1-1/2"	BRASSNIP2X31/2	2" x 3-1/2"
		BRASSNIP3/4X2	3/4" x 2"	BRASSNIP2X4	2" x 4"
		BRASSNIP3/4X21/2	3/4" x 2-1/2"	BRASSNIP2X41/2	2" x 4-1/2"
BRASSNIP1/8XCLOSE	1/8" x Close	BRASSNIP3/4X3	3/4" x 3"	BRASSNIP2X5	2" x 5"
BRASSNIP1/8X11/2	1/8" x 1-1/2"	BRASSNIP3/4X31/2	3/4" x 3-1/2"	BRASSNIP2X51/2	2" x 5-1/2"
BRASSNIP1/8X2	1/8" x 2"	BRASSNIP3/4X4	3/4" x 4"	BRASSNIP2X6	2" x 6"
BRASSNIP1/8X21/2	1/8" x 2-1/2"	BRASSNIP3/4X41/2	3/4" x 4-1/2"		
BRASSNIP1/8X3	1/8" x 3"	BRASSNIP3/4X5	3/4" x 5"		
BRASSNIP1/8X31/2	1/8" x 3-1/2"	BRASSNIP3/4X51/2	3/4" x 5-1/2"		
BRASSNIP1/4XCLOSE	1/4" x Close	BRASSNIP3/4X6	3/4" x 6"		
BRASSNIP1/4X11/2	1/4" x 1-1/2"	BRASSNIP1XCLOSE	1" x Close		
BRASSNIP1/4X2	1/4" x 2"	BRASSNIP1X2	1" x 2"		
BRASSNIP1/4X21/2	1/4" x 2-1/2"	BRASSNIP1X21/2	1" x 2-1/2"		
BRASSNIP1/4X3	1/4" x 3"	BRASSNIP1X3	1" x 3"		
BRASSNIP1/4X31/2	1/4" x 3-1/2"	BRASSNIP1X31/2	1" x 3-1/2"		
BRASSNIP1/4X4	1/4" x 4"	BRASSNIP1X4	1" x 4"		
BRASSNIP1/4X41/2	1/4" x 4-1/2"	BRASSNIP1X41/2	1" x 4-1/2"		
BRASSNIP1/4X5	1/4" x 5"	BRASSNIP1X5	1" x 5"		
BRASSNIP1/4X51/2	1/4" x 5-1/2"	BRASSNIP1X51/2	1" x 5-1/2"		
BRASSNIP1/4X6	1/4" x 6"	BRASSNIP1X6	1" x 6"		
BRASSNIP3/8XCLOSE	3/8" x Close	BRASSNIP11/4XCLOSE	1-1/4" x Close		
BRASSNIP3/8X11/2	3/8" x 1-1/2"	BRASSNIP11/4X2	1-1/4" x 2"		
BRASSNIP3/8X2	3/8" x 2"	BRASSNIP11/4X21/2	1-1/4" x 2-1/2"		
BRASSNIP3/8X21/2	3/8" x 2-1/2"	BRASSNIP11/4X3	1-1/4" x 3"		
BRASSNIP3/8X3	3/8" x 3"	BRASSNIP11/4X31/2	1-1/4" x 3-1/2"		
BRASSNIP3/8X31/2	3/8" x 3-1/2"	BRASSNIP11/4X4	1-1/4" x 4"		
BRASSNIP3/8X4	3/8" x 4"	BRASSNIP11/4X41/2	1-1/4" x 4-1/2"		
BRASSNIP3/8X41/2	3/8" x 4-1/2"	BRASSNIP11/4X5	1-1/4" x 5"		
BRASSNIP3/8X5	3/8" x 5"	BRASSNIP11/4X51/2	1-1/4" x 5-1/2"		
BRASSNIP3/8X51/2	3/8" x 5-1/2"	BRASSNIP11/4X6	1-1/4" x 6"		
BRASSNIP3/8X6	3/8" x 6"	BRASSNIP11/2XCLOSE	1-1/2" x Close		
BRASSNIP1/2XCLOSE	1/2" x Close	BRASSNIP11/2X2	1-1/2" x 2"		
BRASSNIP1/2X11/2	1/2" x 1-1/2"	BRASSNIP11/2X21/2	1-1/2" x 2-1/2"		
BRASSNIP1/2X2	1/2" x 2"	BRASSNIP11/2X3	1-1/2" x 3"		
BRASSNIP1/2X21/2	1/2" x 2-1/2"	BRASSNIP11/2X31/2	1-1/2" x 3-1/2"		
BRASSNIP1/2X3	1/2" x 3"	BRASSNIP11/2X4	1-1/2" x 4"		
BRASSNIP1/2X31/2	1/2" x 3-1/2"	BRASSNIP11/2X41/2	1-1/2" x 4-1/2"		
BRASSNIP1/2X4	1/2" x 4"	BRASSNIP11/2X5	1-1/2" x 5"		
BRASSNIP1/2X41/2	1/2" x 4-1/2"	BRASSNIP11/2X51/2	1-1/2" x 5-1/2"		
BRASSNIP1/2X5	1/2" x 5"	BRASSNIP11/2X6	1-1/2" x 6"		
BRASSNIP1/2X51/2	1/2" x 5-1/2"	BRASSNIP2XCLOSE	2" x Close		
BRASSNIP1/2X6	1/2" x 6"	BRASSNIP2X21/2	2" x 2-1/2"		
BRASSNIP3/4XCLOSE	3/4" x Close"	BRASSNIP2X3	2" x 3"		

COPPER WROT FITTINGS

90 Degree Elbow

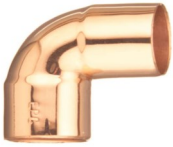

- . Used to change direction in piping
- . May also be called a "1/4 bend"

Part No#	Size	Type
COPELL1/4	1/4"	C x C
COPELL3/8	3/8"	C x C
COPELL1/2	1/2"	C x C
COPELL3/4	3/4"	C x C
COPELL1	1"	C x C
COPELL11/4	1-1/4"	C x C
COPELL11/2	1-1/2"	C x C
COPELL2	2"	C x C
COPELL21/2	2-1/2"	C x C
COPELL3	3"	C x C
COPELL4	4"	C x C

90 Degree Street Elbow



- . Used to change direction in piping
- . May also be called a "street 1/4 bend"

Part No#	Size	Type
COPSTELL1/4	1/4"	FTG x C
COPSTELL3/8	3/8"	FTG x C
COPSTELL1/2	1/2"	FTG x C
COPSTELL3/4	3/4"	FTG x C
COPSTELL1	1"	FTG x C
COPSTELL11/4	1-1/4"	FTG x C
COPSTELL11/2	1-1/2"	FTG x C
COPSTELL2	2"	FTG x C
COPSTELL21/2	2-1/2"	FTG x C
COPSTELL3	3"	FTG x C
COPSTELL4	4"	FTG x C

90 Degree Reducing Elbow

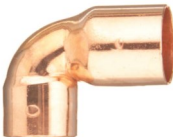

- . Used to change direction in piping
- . May also be called a "reducing 1/4 bend"

Part No#	Size	Type
COPELL3/4X1/2	3/4" x 1/2"	C x C
COPELL1X1/2	1" x 1/2"	C x C
COPELL1X3/4	1" x 3/4"	C x C
COPELL2X11/2	2" x 1-1/2"	C x C

45 Degree Elbow



- . Used to change direction in piping
- . May also be called a "1/8 bend"

Part No#	Size	Type
COP451/2	1/2"	C x C
COP453/4	3/4"	C x C
COP451	1"	C x C
COP4511/4	1-1/4"	C x C
COP4511/2	1-1/2"	C x C
COP452	2"	C x C
COP4521/2	2-1/2"	C x C
COP453	3"	C x C
COP454	4"	C x C

45 Degree Street Elbow



- . Used to change direction in piping
- . May also be called a "street 1/8 bend"

Part No#	Size	Type
COPST451/2	1/2"	Ftg x C
COPST453/4	3/4"	Ftg x C
COPST451	1"	Ftg x C
COPST4511/4	1-1/4"	Ftg x C
COPST4511/2	1-1/2"	Ftg x C
COPST452	2"	Ftg x C
COPST4521/2	2-1/2"	Ftg x C
COPST453	3"	Ftg x C
COPST454	4"	Ftg x C

COPPER WROT FITTINGS

Tee

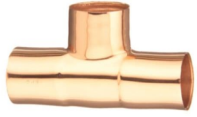

. Used to connect a third line onto an existing line

Part No#	Size	Type
COPTEE1/4	1/4"	C x C x C
COPTEE3/8	3/8"	C x C x C
COPTEE1/2	1/2"	C x C x C
COPTEE3/4	3/4"	C x C x C
COPTEE1	1"	C x C x C
COPTEE11/4	1-1/4"	C x C x C
COPTEE11/2	1-1/2"	C x C x C
COPTEE2	2"	C x C x C
COPTEE21/2	2-1/2"	C x C x C
COPTEE3	3"	C x C x C
COPTEE4	4"	C x C x C

Bullhead Tee



. Used to connect a third line onto an existing line

Part No#	Size	Type
COPTEE1/2X1/2X3/4	1/2" x 1/2" x 3/4"	C x C x C
COPTEE3/4X3/4X1	3/4" x 3/4" x 1"	C x C x C
COPTEE1X1X1/4	1" x 1" x 1-1/4"	C x C x C
COPTEE1X1X1/2	1" x 1" x 1-1/2"	C x C x C
COPTEE11/4X11/4X11/2	1-1/4" x 1-1/4" x 1-1/2"	C x C x C
COPTEE11/2X11/2X2	1-1/2" x 1-1/2" x 2"	C x C x C
COPTEE2X2X21/2	2" x 2" x 2-1/2"	C x C x C

Reducing Tee - Two Sizes

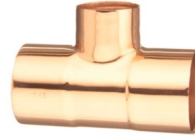

. Used to connect a third line onto an existing line

Part No#	Size	Type
COPTEE3/4X1/2	3/4" x 3/4" x 1/2"	C x C x C
COPTEE1X1/2	1" x 1" x 1/2"	C x C x C
COPTEE1X3/4	1" x 1" x 3/4"	C x C x C
COPTEE11/4X1/2	1-1/4" x 1-1/4" x 1/2"	C x C x C
COPTEE11/4X3/4	1-1/4" x 1-1/4" x 3/4"	C x C x C
COPTEE11/4X1	1-1/4" x 1-1/4" x 1"	C x C x C
COPTEE11/2X1/2	1-1/2" x 1-1/2" x 1/2"	C x C x C
COPTEE11/2X3/4	1-1/2" x 1-1/2" x 3/4"	C x C x C
COPTEE11/2X1	1-1/2" x 1-1/2" x 1"	C x C x C
COPTEE11/2X11/4	1-1/2" x 1-1/2" x 11/4"	C x C x C
COPTEE2X1/2	2" x 2" x 1/2"	C x C x C
COPTEE2X3/4	2" x 2" x 3/4"	C x C x C
COPTEE2X1	2" x 2" x 1"	C x C x C
COPTEE2X11/4	2" x 2" x 1-1/4"	C x C x C
COPTEE2X11/2	2" x 2" x 1-1/2"	C x C x C
COPTEE21/2X1/2	2-1/2" x 2-1/2" x 1/2"	C x C x C
COPTEE21/2X3/4	2-1/2" x 2-1/2" x 3/4"	C x C x C
COPTEE21/2X2	2-1/2" x 2-1/2" x 1"	C x C x C
COPTEE21/2X11/4	2-1/2" x 2-1/2" x 1-1/4"	C x C x C
COPTEE21/2X11/2	2-1/2" x 2-1/2" x 1-1/2"	C x C x C
COPTEE21/2X2	2-1/2" x 2-1/2" x 2"	C x C x C
COPTEE3X1/2	3" x 3" x 1/2"	C x C x C
COPTEE3X3/4	3" x 3" x 3/4"	C x C x C
COPTEE3X1	3" x 3" x 1"	C x C x C
COPTEE3X11/4	3" x 3" x 1-1/4"	C x C x C
COPTEE3X11/2	3" x 3" x 1-1/2"	C x C x C
COPTEE3X2	3" x 3" x 2"	C x C x C
COPTEE3X21/2	3" x 3" x 2-1/2"	C x C x C
COPTEE4X1	4" x 4" x 1"	C x C x C
COPTEE4X11/2	4" x 4" x 1-1/2"	C x C x C
COPTEE4X2	4" x 4" x 2"	C x C x C
COPTEE4X21/2	4" x 4" x 2-1/2"	C x C x C
COPTEE4X3	4" x 4" x 3"	C x C x C

COPPER WROT FITTINGS

Reducing Tee - Three Sizes



Used to connect a third line onto an existing line

Part No#	Size	Type
COPTEE3/4X1/2X1/2	3/4" x 1/2" x 1/2"	C x C x C
COPTEE3/4X1/2X3/4	3/4" x 1/2" x 3/4"	C x C x C
COPTEE1X1/2X1/2	1" x 1/2" x 1/2"	C x C x C
COPTEE1X1/2X3/4	1" x 1/2" x 3/4"	C x C x C
COPTEE1X1/2X1	1" x 1/2" x 1"	C x C x C
COPTEE1X3/4X1/2	1" x 3/4" x 1/2"	C x C x C
COPTEE1X3/4X3/4	1" x 3/4" x 3/4"	C x C x C
COPTEE1X3/4X1	1" x 3/4" x 1"	C x C x C
COPTEE11/4X1/2X11/4	1-1/4" x 1/2" x 1-1/4"	C x C x C
COPTEE11/4X3/4X1/2	1-1/4" x 3/4" x 1/2"	C x C x C
COPTEE11/4X3/4X3/4	1-1/4" x 3/4" x 3/4"	C x C x C
COPTEE11/4X3/4X1	1-1/4" x 3/4" x 1"	C x C x C
COPTEE11/4X3/4X11/4	1-1/4" x 3/4" x 1-1/4"	C x C x C
COPTEE11/4X1X1/2	1-1/4" x 1" x 1/2"	C x C x C
COPTEE11/4X1X3/4	1-1/4" x 1" x 3/4"	C x C x C
COPTEE11/4X1X1	1-1/4" x 1" x 1"	C x C x C
COPTEE11/4X1X11/4	1-1/4" x 1" x 1-1/4"	C x C x C
COPTEE11/2X1/2X11/2	1-1/2" x 1/2" x 1-1/2"	C x C x C
COPTEE11/2X3/4X1/2	1-1/2" x 3/4" x 1/2"	C x C x C
COPTEE11/2X3/4X3/4	1-1/2" x 3/4" x 3/4"	C x C x C
COPTEE11/2X3/4X1	1-1/2" x 3/4" x 1"	C x C x C
COPTEE11/2X3/4X11/2	1-1/2" x 3/4" x 1-1/2"	C x C x C
COPTEE11/2X1X11/2	1-1/2" x 1" x 1-1/2"	C x C x C
COPTEE11/2X1X1/2	1-1/2" x 1" x 1/2"	C x C x C
COPTEE11/2X1X3/4	1-1/2" x 1" x 3/4"	C x C x C
COPTEE11/2X1X1	1-1/2" x 1" x 1"	C x C x C
COPTEE11/2X1X11/4	1-1/2" x 1" x 1-1/4"	C x C x C
COPTEE11/2X11/4X1/2	1-1/2" x 1-1/4" x 1/2"	C x C x C
COPTEE11/2X11/4X3/4	1-1/2" x 1-1/4" x 3/4"	C x C x C
COPTEE11/2X11/4X1	1-1/2" x 1-1/4" x 1"	C x C x C
COPTEE11/2X11/4X11/4	1-1/2" x 1-1/4" x 1-1/4"	C x C x C
COPTEE11/2X11/4X11/2	1-1/2" x 1-1/4" x 1-1/2"	C x C x C
COPTEE2X1/2X2	2" x 1/2" x 2"	C x C x C
COPTEE2X3/4X2	2" x 3/4" x 2"	C x C x C
COPTEE2x1x1	2" x 1" x 1"	C x C x C
COPTEE2X1X2	2" x 1" x 2"	C x C x C
COPTEE2X11/4X3/4	2" x 1-1/4" x 3/4"	C x C x C
COPTEE2X11/4X1	2" x 1-1/4" x 1"	C x C x C
COPTEE2X11/4X11/4	2" x 1-1/4" x 1-1/4"	C x C x C

Reducing Tee - Three Sizes (continued)

Part No#	Size	Type
COPTEE2X11/4X2	2" x 1-1/4" x 2"	C x C x C
COPTEE2X11/2X3/4	2" x 1-1/2" x 3/4"	C x C x C
COPTEE2X11/2X1	2" x 1-1/2" x 1"	C x C x C
COPTEE2X11/2X11/4	2" x 1-1/2" x 1-1/4"	C x C x C
COPTEE2X11/2X11/2	2" x 1-1/2" x 1-1/2"	C x C x C
COPTEE2X11/2X2	2" x 1-1/2" x 2"	C x C x C
COPTEE21/2X11/2X11/2	2-1/2" x 1-1/2" x 1-1/2"	C x C x C
COPTEE21/2X2X2	2-1/2" x 2" x 2"	C x C x C
COPTEE21/2X2X21/2	2-1/2" x 2" x 2-1/2"	C x C x C
COPTEE3X2X2	3" x 2" x 2"	C x C x C
COPTEE3X2X3	3" x 2" x 3"	C x C x C

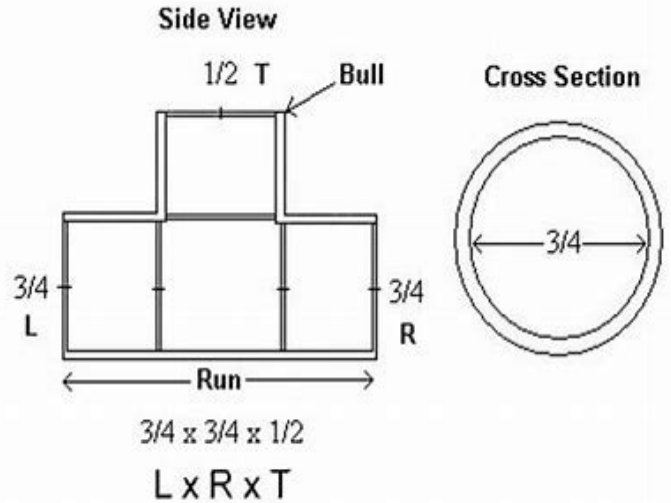

COPPER WROT FITTINGS

Male Adapter



. Adapts copper to standard male pipe thread

Part No#	Size	Type
COPMIPADPT3/8	3/8"	C x MPT
COPMIPADPT1/2	1/2"	C x MPT
COPMIPADPT3/4	3/4"	C x MPT
COPMIPADPT1	1"	C x MPT
COPMIPADPT11/4	1-1/4"	C x MPT
COPMIPADPT11/2	1-1/2"	C x MPT
COPMIPADPT2	2"	C x MPT
COPMIPADPT21/2	2-1/2"	C x MPT
COPMIPADPT3	3"	C x MPT
COPMIPADPT4	4"	C x MPT

Female Adapter



. Adapts copper to standard female pipe thread

Part No#	Size	Type
COPFIPADPT1/4	1/4"	C x FPT
COPFIPADPT3/8	3/8"	C x FPT
COPFIPADPT1/2	1/2"	C x FPT
COPFIPADPT3/4	3/4"	C x FPT
COPFIPADPT1	1"	C x FPT
COPFIPADPT11/4	1-1/4"	C x FPT
COPFIPADPT11/2	1-1/2"	C x FPT
COPFIPADPT2	2"	C x FPT
COPFIPADPT21/2	2-1/2"	C x FPT
COPFIPADPT3	3"	C x FPT

Fitting Male Adapter

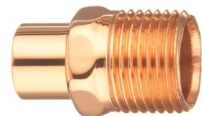

. Adapts from copper hub to standard male pipe thread

Part No#	Size	Type
COPFTGXADPT1/2	1/2"	FTG x MPT
COPFTGXADPT3/4	3/4"	FTG x MPT
COPFTGXADPT1	1"	FTG x MPT
COPFTGXADPT11/4	1-1/4"	FTG x MPT
COPFTGXADPT11/2	1-1/2"	FTG x MPT
COPFTGXADPT2	2"	FTG x MPT

Fitting Female Adapter

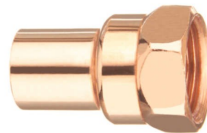

. Adapts from copper hub to standard female pipe thread

Part No#	Size	Type
COPFTGXFADPT1/2	1/2"	FTG x FPT
COPFTGXFADPT3/4	3/4"	FTG x FPT
COPFTGXFADPT1	1"	FTG x FPT
COPFTGXFADPT11/4	1-1/4"	FTG x FPT
COPFTGXFADPT11/2	1-1/2"	FTG x FPT
COPFTGXFADPT2	2"	FTG x FPT

Reducing Male Adapter



. Adapts copper to standard male pipe thread

Part No#	Size	Type
COPMIPADPT1/2X3/8	1/2" x 3/8"	C x MPT
COPMIPADPT1/2X3/4	1/2" x 3/4"	C x MPT
COPMIPADPT3/4X1/2	3/4" x 1/2"	C x MPT
COPMIPADPT3/4X1	3/4" x 1"	C x MPT
COPMIPADPT1X1/2	1" x 1/2"	C x MPT
COPMIPADPT1X3/4	1" x 3/4"	C x MPT
COPMIPADPT11/4X2	1-1/4" x 2"	C x MPT

Reducing Female Adapter



. Adapts copper to standard female pipe thread

Part No#	Size	Type
COPFIPADPT1/2X1/4	1/2" x 1/4"	C x FPT
COPFIPADPT1/2X3/8	1/2" x 3/8"	C x FPT
COPFIPADPT1/2X3/4	1/2" x 3/4"	C x FPT
COPFIPADPT3/4X1/2	3/4" x 1/2"	C x FPT
COPFIPADPT3/4X1	3/4" x 1"	C x FPT
COPFIPADPT1X1/2	1" x 1/2"	C x FPT
COPFIPADPT1X3/4	1" x 3/4"	C x FPT

COPPER WROT FITTINGS

Cap

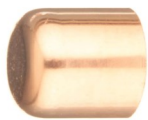

. Used to cap off copper pipe

Part No#	Size	Type
COPCAP1/4	1/4"	C
COPCAP3/8	3/8"	C
COPCAP1/2	1/2"	C
COPCAP3/4	3/4"	C
COPCAP1	1"	C
COPCAP11/4	1-1/4"	C
COPCAP11/2	1-1/2"	C
COPCAP2	2"	C
COPCAP21/2	2-1/2"	C
COPCAP3	3"	C
COPCAP4	4"	C

WROT Test Cap



. Used to cap off copper pipe

Part No#	Size	Type
COPTSTCAP3/4	3/4"	C
COPTSTCAP11/2	1-1/2"	C

Fitting Flush Bushing

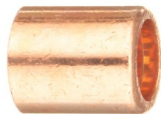

. Fits into a copper fitting hub and accepts copper pipe to make a flush connection

Part No#	Size	Type
COPFTGBUSH3/4x1/2	3/4" x 1/2"	FTG x C
COPFTGBUSH1x1/2	1" x 1/2"	FTG x C
COPFTGBUSH1x3/4	1" x 3/4"	FTG x C

Fitting Female Flush Bushing



. Fits into a copper fitting and accepts a standard male pipe thread for a flush connection

Part No#	Size	Type
COPFTGXFBUSH1/2 x1/8	1/2" x 1/8"	FTG x FPT
COPFTGXFBUSH1/2 x1/4	1/2" x 1/4"	FTG x FPT
COPFTGXFBUSH1x1/2	1" x 1/2"	FTG x FPT

Male Flush Bushing



. Standard male pipe threads into a fitting and accepts copper pipe to make a flush connection

Part No#	Size	Type
SIO1/2MIPxSWTFLBUSH	1/2"	MPT x C

Coupling With Dimple Stop



. Used to join straight lengths of pipe together

Part No#	Size	Type
COPCOUP1/4	1/4"	C x C
COPCOUP3/8	3/8"	C x C
COPCOUP1/2	1/2"	C x C
COPCOUP3/4	3/4"	C x C
COPCOUP1	1"	C x C
COPCOUP11/4	1-1/4"	C x C
COPCOUP11/2	1-1/2"	C x C
COPCOUP2	2"	C x C
COPCOUP21/2	2-1/2"	C x C
COPCOUP3	3"	C x C
COPCOUP4	4"	C x C

Coupling Less Stop



. Used to slip over copper pipe to join two lengths together
. May also be called a "slip coupling" or "repair coupling"

Part No#	Size	Type
COPSLIPCOUP1/2	1/2"	C x C
COPSLIPCOUP3/4	3/4"	C x C
COPSLIPCOUP1	1"	C x C
COPSLIPCOUP11/4	1-1/4"	C x C
COPSLIPCOUP11/2	1-1/2"	C x C
COPSLIPCOUP2	2"	C x C
COPSLIPCOUP21/2	2-1/2"	C x C
COPSLIPCOUP3	3"	C x C
COPSLIPCOUP4	4"	C x C

COPPER WROT FITTINGS

Reducing Coupling

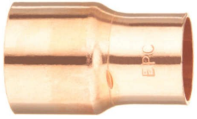

. Used to reduce and join straight lengths of pipe together

Part No#	Size	Type
COPCOUP1/4X1/8	1/4" x 1/8"	C x C
COPCOUP3/8X1/4	3/8" x 1/4"	C x C
COPCOUP1/2X1/8	1/2" x 1/8"	C x C
COPCOUP1/2X1/4	1/2" x 1/4"	C x C
COPCOUP1/2X3/8	1/2" x 3/8"	C x C
COPCOUP3/4X1/2	3/4" x 1/2"	C x C
COPCOUP1X1/2	1" x 1/2"	C x C
COPCOUP1X3/4	1" x 3/4"	C x C
COPCOUP11/4X1/2	1-1/4" x 1/2"	C x C
COPCOUP11/4X3/4	1-1/4" x 3/4"	C x C
COPCOUP11/4X1	1-1/4" x 1"	C x C
COPCOUP11/2X1/2	1-1/2" x 1/2"	C x C
COPCOUP11/2X3/4	1-1/2" x 3/4"	C x C
COPCOUP11/2X1	1-1/2" x 1"	C x C
COPCOUP11/2X11/4	1-1/2" x 1-1/4"	C x C
COPCOUP2X1/2	2" x 1/2"	C x C
COPCOUP2X3/4	2" x 3/4"	C x C
COPCOUP2X1	2" x 1"	C x C
COPCOUP2X11/4	2" x 1-1/4"	C x C
COPCOUP2X11/2	2" x 1-1/2"	C x C
COPCOUP21/2X1	2-1/2" x 1"	C x C
COPCOUP21/2X11/4	2-1/2" x 1-1/4"	C x C
COPCOUP21/2X11/2	2-1/2" x 1-1/2"	C x C
COPCOUP21/2X2	2-1/2" x 2"	C x C
COPCOUP3X11/2	3" x 1-1/2"	C x C
COPCOUP3X2	3" x 2"	C x C
COPCOUP3X21/2	3" x 2-1/2"	C x C
COPCOUP4X2	4" x 2"	C x C
COPCOUP4X21/2	4" x 2-1/2"	C x C
COPCOUP4X3	4" x 3"	C x C

Fitting Reducer

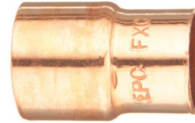

. Used to fit into the hub of a fitting to reduce it down

Part No#	Size	Type
COPFTGRED1/4X1/8	1/4" x 1/8"	FTG x C
COPFTGRED3/8X1/4	3/8" x 1/4"	FTG x C
COPFTGRED1/2X1/4	1/2" x 1/4"	FTG x C
COPFTGRED1/2X3/8	1/2" x 3/8"	FTG x C
COPFTGRED3/4X1/4	3/4" x 1/4"	FTG x C
COPFTGRED3/4X1/2	3/4" x 1/2"	FTG x C
COPFTGRED1X1/2	1" x 1/2"	FTG x C
COPFTGRED1X3/4	1" x 3/4"	FTG x C
COPFTGRED11/4X1/2	1-1/4" x 1/2"	FTG x C
COPFTGRED11/4X3/4	1-1/4" x 3/4"	FTG x C
COPFTGRED11/4X1	1-1/4" x 1"	FTG x C
COPFTGRED11/2X1/2	1-1/2" x 1/2"	FTG x C
COPFTGRED11/2X3/4	1-1/2" x 3/4"	FTG x C
COPFTGRED11/2X1	1-1/2" x 1"	FTG x C
COPFTGRED11/2X11/4	1-1/2" x 1-1/4"	FTG x C
COPFTGRED2X1/2	2" x 1/2"	FTG x C
COPFTGRED2X3/4	2" x 3/4"	FTG x C
COPFTGRED2X1	2" x 1"	FTG x C
COPFTGRED2X11/4	2" x 1-1/4"	FTG x C
COPFTGRED2X11/2	2" x 1-1/2"	FTG x C
COPFTGRED21/2X1	2-1/2" x 1"	FTG x C
COPFTGRED21/2X11/4	2-1/2" x 1-1/4"	FTG x C
COPFTGRED21/2X11/2	2-1/2" x 1-1/2"	FTG x C
COPFTGRED21/2X2	2-1/2" x 2"	FTG x C
COPFTGRED3X11/4	3" X 1-1/4"	FTG x C
COPFTGRED3X11/2	3" x 1-1/2"	FTG x C
COPFTGRED3X2	3" x 2"	FTG x C
COPFTGRED3X21/2	3" x 2-1/2"	FTG x C
COPFTGRED4X2	4" x 2"	FTG x C
COPFTGRED4X21/2	4" x 2-1/2"	FTG x C
COPFTGRED4X3	4" x 3"	FTG x C

COPPER CAST FITTINGS

90 Degree Male Elbow



- . 90 degree elbow adapts copper to standard male pipe thread
- . Lead free

Part No#	Size	Type
COPMPELL1/2	1/2"	C x MPT
COPMPELL3/4	3/4"	C x MPT
COPMPELL1	1"	C x MPT
COPMPELL11/4	1-1/4"	C x MPT
COPMPELL11/2	1-1/2"	C x MPT
COPMPELL2	2"	C x MPT

90 Degree Female Elbow



- . 90 degree elbow adapts copper to standard female pipe thread
- . May also be called a "meter elbow"
- . Lead free

Part No#	Size	Type
COPFPELL1/2	1/2"	C x FPT
COPFPELL3/4	3/4"	C x FPT
COPFPELL1	1"	C x FPT
COPFPELL11/4	1-1/4"	C x FPT
COPFPELL11/2	1-1/2"	C x FPT
COPFPELL2	2"	C x FPT

90 Degree Reducing Female Elbow



- . 90 degree elbow adapts copper to standard female pipe thread
- . May also be called a "meter elbow"
- . Lead free

Part No#	Size	Type
COPFPELL1/2X3/4	1/2" x 3/4"	C x FPT
COPFPELL3/4X1/2	3/4" x 1/2"	C x FPT
COPFPELL3/4X1	3/4" x 1"	C x FPT
COPFPELL1X1/2	1" x 1/2"	C x FPT
COPFPELL1X3/4	1" x 3/4"	C x FPT

90 Degree Female Wing Elbow



- . 90 Degree elbow adapts copper to standard female pipe thread
- . Includes bracket for easy mounting
- . May also be called a "shower elbow"
- . Lead free

Part No#	Size	Type
COPFIPWINGELL1/2	1/2"	C x FPT
COPFIPWINGELL3/4	3/4"	C x FPT

90 Degree Flanged Sink Elbow



- . 90 degree elbow adapts copper to standard female pipe thread
- . Most commonly used for commercial faucets
- . Lead free

Part No#	Size	Type
COPFIPSINKELL1/2	1/2"	C x FPT

90 Degree Wing Elbow



- . 90 degree elbow includes copper bracket for easy mounting
- . May also be called a "shower elbow"
- . Lead free

Part No#	Size	Type
COPWINGELL1/2	1/2"	C x C

90 Degree Drain Elbow



- . 90 degree elbow includes 1/8 drain port with cap
- . Lead free

Part No#	Size	Type
COPDRAINELL1/2	1/2"	C x C
COPDRAINELL3/4	3/4"	C x C
COPDRAINELL1	1"	C x C

Drain Coupling



- . Standard coupling includes 1/8 drain port with cap
- . Lead free

Part No#	Size	Type
COPDRAINCOUP1/2	1/2"	C x C
COPDRAINCOUP3/4	3/4"	C x C
COPDRAINCOUP1	1"	C x C

Baseboard Tee



- . 90 degree elbow with 1/8 FPT tapping usually for a coin vent
- . Most typically used for baseboard heating
- . Lead free

Part No#	Size	Type
COPBASETEE3/4x1/8	3/4" x 1/8" x 3/4"	C x FPT x C
COPBASETEE1x1/8x1	1" x 1/8" x 1"	C x FPT x C

COPPER CAST FITTINGS

Copper Cross Tee



- . Cross tee accepts copper on all four sides
- . Lead free

Part No#	Size	Type
COPCROSS3/4	3/4"	C x C x C x C

Tapped Wing Tee



- . Copper tee with standard female pipe thread tapping
- . Includes bracket for easy mounting
- . Lead free

Part No#	Size	Type
COPFIPWINGTEE1/2	1/2"	C x C x FPT
COPFIPWINGTEE3/4	3/4"	C x C x FPT

Tapped Tee



- . Copper tee with standard female pipe thread tapping
- . Lead free

Part No#	Size	Type
COPFIPTTEE1/2	1/2"	C x C x FPT
COPFIPTTEE3/4	3/4"	C x C x FPT
COPFIPTTEE1	1"	C x C x FPT

Reducing Tapped Tee



- . Copper tee with standard female pipe thread tapping
- . Lead free

Part No#	Size	Type
COPFIPTTEE3/4X1/2	3/4" x 3/4" x 1/2"	C x C x FPT
COPFIPTTEE1X1/2	1" x 1" x 1/2"	C x C x FPT
COPFIPTTEE1X3/4	1" x 1" x 3/4"	C x C x FPT
COPFIPTTEE11/4X1/2	1-1/4" x 1-1/4" x 1/2"	C x C x FPT
COPFIPTTEE11/4X3/4	1-1/4" X 1-1/4" X 3/4"	C x C x FPT
COPFIPTTEE11/2X1/2	1-1/2" x 1-1/2" x 1/2"	C x C x FPT
COPFIPTTEE11/2X3/4	1-1/2" X 1-1/2" X 3/4"	C x C x FPT
COPFIPTTEE2X1/2	2" x 2" x 1/2"	C x C x FPT
COPFIPTTEE2X3/4	2" x 2" x 3/4"	C x C x FPT
COPFIPTTEE2X1	2" x 2" x 1"	C x C x FPT

Copper Union

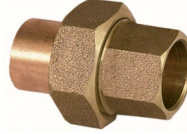

- . Used to join straight lengths of pipe together for easy removal

Part No#	Size	Type
COPUNION1/2	1/2"	C x C
COPUNION3/4	3/4"	C x C
COPUNION1	1"	C x C
COPUNION11/4	1-1/4"	C x C
COPUNION11/2	1-1/2"	C x C
COPUNION2	2"	C x C

Copper Male Union

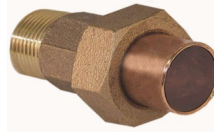

- . Union adapts copper to standard male pipe thread
- . Lead Free

Part No#	Size	Type
COPMIPUNION1/2	1/2"	C x MPT
COPMIPUNION3/4	3/4"	C x MPT
COPMIPUNION1	1"	C x MPT
COPMIPUNION11/4	1-1/4"	C x MPT
COPMIPUNION11/2	1-1/2"	C x MPT
COPMIPUNION2	2"	C x MPT

Copper Female Union



- . Union adapts copper to standard female pipe thread
- . Lead free

Part No#	Size	Type
COPFIPUNION1/2	1/2"	C x FPT
COPFIPUNION3/4	3/4"	C x FPT
COPFIPUNION1	1"	C x FPT
COPFIPUNION11/4	1-1/4"	C x FPT
COPFIPUNION11/2	1-1/2"	C x FPT
COPFIPUNION2	2"	C x FPT

Cast Companion Flange



- . Cast brass companion flange accepts copper pipe
- . Gaskets and bolts not included
- . Lead free

Part No#	Size	Type
COPCOMPFLANGE21/2	2-1/2"	C
COPCOMPFLANGE3	3"	C
COPCOMPFLANGE4	4"	C

COPPER DWV FITTINGS

90 Degree Elbow



- . Used to change direction in piping
- . May also be called a "1/4 bend"
- . **MUST BE USED FOR DRAINAGE PURPOSES ONLY**

Part No#	Size	Type
DWVELL11/2	1-1/2"	C x C
DWVELL2	2"	C x C

90 Degree Street Elbow



- . Used to change direction in piping
- . May also be called a "street 1/4 bend"
- . **MUST BE USED FOR DRAINAGE PURPOSES ONLY**

Part No#	Size	Type
DWVSTELL11/2	1-1/2"	FTG x C
DWVSTELL2	2"	FTG x C

45 Degree Elbow



- . Used to change direction in piping
- . May also be called a "1/8 bend"
- . **MUST BE USED FOR DRAINAGE PURPOSES ONLY**

Part No#	Size	Type
DWV4511/2	1-1/2"	C x C
DWV452	2"	C x C

45 Degree Street Elbow



- . Used to change direction in piping
- . May also be called a "street 1/8 bend:"
- . **MUST BE USED FOR DRAINAGE PURPOSES ONLY**

Part No#	Size	Type
DWVST4511/2	1-1/2"	FTG x C
DWVST452	2"	FTG x C

22 1/2 Degree Elbow



- . Used to change direction in piping
- . May also be called a "1/16 bend"
- . **MUST BE USED FOR DRAINAGE PURPOSES ONLY**

Part No#	Size	Type
DWV221/211/2	1-1/2"	C x C
DWV221/22	2"	C x C

60 Degree Elbow



- . Used to change direction in piping
- . May also be called a "1/6 bend"
- . **MUST BE USED FOR DRAINAGE PURPOSES ONLY**

Part No#	Size	Type
DWV6011/2	1-1/2"	C x C
DWV602	2"	C x C

Wye



- . Used to connect branch line to horizontal drain line
- . **MUST BE USED FOR DRAINAGE PURPOSES ONLY**

Part No#	Size	Type
DWVWYE11/2	1-1/2"	C x C x C
DWVWYE2	2"	C x C x C

Reducing Wye



- . Used to connect branch line to horizontal drain line
- . **MUST BE USED FOR DRAINAGE PURPOSES ONLY**

Part No#	Size	Type
DWVWYE2X11/2	2" x 2" x 1-1/2"	C x C x C
DWVWYE2X11/2X11/2	2" x 1-1/2" x 1-1/2"	C x C x C

Sanitary Tee



- . Used to connect a branch line into a vertical branch line
- . **MUST BE USED FOR DRAINAGE PURPOSES ONLY**

Part No#	Size	Type
DWVSANTEE11/2	1-1/2"	C x C x C
DWVSANTEE2	2"	C x C x C

Reducing Sanitary Tee



- . Used to connect a branch line into a vertical branch line
- . **MUST BE USED FOR DRAINAGE PURPOSES ONLY**

Part No#	Size	Type
DWVSANTEE2X11/2	2" x 2" x 1-1/2"	C x C x C
DWVSANTEE2X11/2X11/2	2" x 1-1/2" x 1-1/2"	C x C x C

COPPER DWV FITTINGS

Cleanout Tee With Raised Head Plug



- . Used with a threaded plug to provide a cleanout opening
- . **MUST BE USED FOR DRAINAGE PURPOSES ONLY**

Part No#	Size	Type
DWVC/OTEE&PLUG11/2	1-1/2"	C x C x FPT
DWVC/OTEE&PLUG2	2"	C x C x FPT

Male Adapter



- . Adapts copper to standard male pipe thread
- . **MUST BE USED FOR DRAINAGE PURPOSES ONLY**

Part No#	Size	Type
DWVMIPADPT11/2	1-1/2"	C x MPT
DWVMIPADPT2	2"	C x MPT

Female Adapter

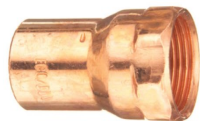

- . Adapts from copper hub to standard female pipe thread
- . **MUST BE USED FOR DRAINAGE PURPOSES ONLY**

Part No#	Size	Type
DWVFIPADPT11/2	1-1/2"	C x FPT
DWVFIPADPT2	2"	C x FPT

Fitting Cleanout With Raised Head Plug



- . Adapts from copper hub to standard female pipe thread
- . **MUST BE USED FOR DRAINAGE PURPOSES ONLY**

Part No#	Size	Type
DWVFITCOWPLUG11/2	1-1/2"	FTG x FPT
DWVFITCOWPLUG2	2"	FTG x FPT

Flush Cleanout With Raised Head Plug



- . Adapts from copper hub to standard female pipe thread
- . **MUST BE USED FOR DRAINAGE PURPOSES ONLY**

Part No#	Size	Type
DWVFLCOWPLUG11/2	1-1/2"	FTG x FPT
DWVFLCOWPLUG2	2"	FTG x FPT

P-Trap



- . Used to trap sewer gases from entering a drain line
- . **MUST BE USED FOR DRAINAGE PURPOSES ONLY**

Part No#	Size	Type
DWVPTRAP11/2	1-1/2"	C x C
DWVPTRAP2	2"	C x C

Coupling With Stop

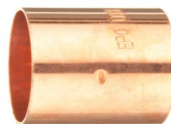

- . Used to join straight lengths of pipe together
- . **MUST BE USED FOR DRAINAGE PURPOSES ONLY**

Part No#	Size	Type
DWVCOUP11/2	1-1/2"	C x C
DWVCOUP2	2"	C x C
DWVCOUP3	3"	C x C

Reducing Coupling



- . Used to reduce and join straight lengths of pipe together
- . **MUST BE USED FOR DRAINAGE PURPOSES ONLY**

Part No#	Size	Type
DWVCOUP2X11/2	2" x 1-1/2"	C x C
DWVCOUP3X11/2	3" x 1-1/2"	C x C
DWVCOUP3X2	3" x 2"	C x C

Fitting Reducer



- . Used to fit into the hub of a fitting to reduce it down
- . **MUST BE USED FOR DRAINAGE PURPOSES ONLY**

Part No#	Size	Type
DWVFTGRED2X11/2	2" x 1-1/2"	FTG x C
DWVFTGRED3X11/2	3" x 1-1/2"	FTG x C
DWVFTGRED3X2	3" x 2"	FTG x C

COPPER PRESS FITTINGS

90 Degree Elbow



- . Used to change direction in piping
- . May also be called a "1/4 bend"

Part No#	Size	Type
PRESSELL1/2	1/2"	Press x Press
PRESSELL3/4	3/4"	Press x Press
PRESSELL1	1"	Press x Press
PRESSELL11/4	1-1/4"	Press x Press
PRESSELL11/2	1-1/2"	Press x Press
PRESSELL2	2"	Press x Press
PRESSELL21/2	2-1/2"	Press x Press
PRESSELL3	3"	Press x Press
PRESSELL4	4"	Press x Press

90 Degree Street Elbow



- . Used to change direction in piping
- . May also be called a "street 1/4 bend"

Part No#	Size	Type
PRESSSTELL1/2	1/2"	FTG x Press
PRESSSTELL3/4	3/4"	FTG x Press
PRESSSTELL1	1"	FTG x Press
PRESSSTELL11/4	1-1/4"	FTG x Press
PRESSSTELL11/2	1-1/2"	FTG x Press
PRESSSTELL2	2"	FTG x Press
PRESSSTELL21/2	2-1/2"	FTG x Press
PRESSSTELL3	3"	FTG x Press

45 Degree Elbow



- . Used to change direction in piping
- . May also be called a "1/8 bend"

Part No#	Size	Type
PRESS451/2	1/2"	Press x Press
PRESS453/4	3/4"	Press x Press
PRESS451	1"	Press x Press
PRESS4511/4	1-1/4"	Press x Press
PRESS4511/2	1-1/2"	Press x Press
PRESS452	2"	Press x Press
PRESS4521/2	2-1/2"	Press x Press
PRESS453	3"	Press x Press
PRESS454	4"	Press x Press

45 Degree Street Elbow



- . Used to change direction in piping
- . May also be called a "street 1/8 bend"

Part No#	Size	Type
PRESSST451/2	1/2"	FTG x Press
PRESSST453/4	3/4"	FTG x Press
PRESSST451	1"	FTG x Press
PRESSST4511/4	1-1/4"	FTG x Press
PRESSST4511/2	1-1/2"	FTG x Press
PRESSST452	2"	FTG x Press
PRESSST4521/2	2-1/2"	FTG x Press
PRESSST453	3"	FTG x Press
PRESSST454	4"	FTG x Press

90 Degree Copper Press Wing Elbow



- . Adapts copper press to standard female pipe threads
- . Includes wing bracket for easy mounting

Part No#	Size	Type
PRESSWINGELL1/2	1/2"	Press x FPT

90 Degree Copper Press Female Elbow



- . Adapts copper press to standard female pipe threads
- . May also be called a "meter elbow"

Part No#	Size	Type
LEG1/2PRESSXFIPELL	1/2"	Press x FPT
LEG3/4PRESSXFIPELL	3/4"	Press x FPT
LEG1PRESSXFIPELL	1"	Press x FPT

90 Degree Copper Press Male Elbow



- . Adapts copper press to standard male pipe threads

Part No#	Size	Type
LEG1/2PRESSXMIPELL	1/2"	Press x MPT
LEG3/4PRESSXMIPELL	3/4"	Press x MPT
LEG1PRESSXMIPELL	1"	Press x MPT

COPPER PRESS FITTINGS

Tee



. Used to connect a third line onto an existing line

Part No#	Size	Type
PRESSTEE1/2	1/2"	Press x Press x Press
PRESSTEE3/4	3/4"	Press x Press x Press
PRESSTEE1	1"	Press x Press x Press
PRESSTEE11/4	1-1/4"	Press x Press x Press
PRESSTEE11/2	1-1/2"	Press x Press x Press
PRESSTEE2	2"	Press x Press x Press
PRESSTEE21/2	2-1/2"	Press x Press x Press
PRESSTEE3	3"	Press x Press x Press
PRESSTEE4	4"	Press x Press x Press

Copper Press Female Tapped Tee



. Copper press tee with female threads in the center
 . Typically used for a boiler drain install

Part No#	Size	Type
LEG1/2PRESSXFIPTEE	1/2"	Press x FPT
LEG3/4PRESSXFIPTEE	3/4"	Press x FPT
LEG3/4X1/2PRESSXFIPT	3/4" x 3/4" x 1/2"	Press x Press x FPT
LEG1X3/4PRESSXFIPTEE	1" x 1" x 3/4"	Press x Press x FPT

Fitting Press Female Adapter



. Adapts from press hub to standard female pipe thread
 . Most commonly used into a tee to accept a boiler drain valve

Part No#	Size	Type
PRESSFTGXFIPADPT1/2	1/2"	FTG x FPT
PRESSFTGXFIPADPT3/4	3/4"	FTG x FPT

Reducing Tee



. Used to connect a third line onto an existing line

Part No#	Size	Type
PRESSTEE3/4X1/2	3/4" x 3/4" x 1/2"	Press x Press x Press
PRESSTEE3/4X1/2X1/2	3/4" x 1/2" x 1/2"	Press x Press x Press
PRESSTEE1X1/2	1" x 1" x 1/2"	Press x Press x Press
PRESSTEE1X3/4	1" x 1" x 3/4"	Press x Press x Press
PRESSTEE1X3/4X3/4	1" x 3/4" x 3/4"	Press x Press x Press
PRESSTEE11/4X1/2	1-1/4" x 1-1/4" x 1/2"	Press x Press x Press
PRESSTEE11/4X3/4	1-1/4" x 1-1/4" x 3/4"	Press x Press x Press
PRESSTEE11/4X1	1-1/4" x 1-1/4" x 1"	Press x Press x Press
PRESSTEE11/2X1/2	1-1/2" x 1-1/2" x 1/2"	Press x Press x Press
PRESSTEE11/2X3/4	1-1/2" x 1-1/2" x 3/4"	Press x Press x Press
PRESSTEE11/2X1	1-1/2" x 1-1/2" x 1"	Press x Press x Press
PRESSTEE11/2X11/4	1-1/2" x 1-1/2" x 1-1/4"	Press x Press x Press
PRESSTEE2X1/2	2" x 2" x 1/2"	Press x Press x Press
PRESSTEE2X3/4	2" x 2" x 3/4"	Press x Press x Press
PRESSTEE2X1	2" x 2" x 1"	Press x Press x Press
PRESSTEE2X11/4	2" x 2" x 1-1/4"	Press x Press x Press
PRESSTEE2X11/2	2" x 2" x 1-1/2"	Press x Press x Press
PRESSTEE21/2X1	2-1/2" x 2-1/2" x 1"	Press x Press x Press
PRESSTEE21/2X11/4	2-1/2" x 2-1/2" x 1-1/4"	Press x Press x Press
PRESSTEE21/2X11/2	2-1/2" x 2-1/2" x 1-1/2"	Press x Press x Press
PRESSTEE21/2X2	2-1/2" x 2-1/2" x 2"	Press x Press x Press
PRESSTEE3X1	3" x 3" x 1"	Press x Press x Press
PRESSTEE3X11/4	3" x 3" x 1-1/4"	Press x Press x Press
PRESSTEE3X11/2	3" x 3" x 1-1/2"	Press x Press x Press
PRESSTEE3X2	3" x 3" x 2"	Press x Press x Press
PRESSTEE3X21/2	3" x 3" x 2-1/2"	Press x Press x Press
PRESSTEE4X2	4" x 4" x 2"	Press x Press x Press
PRESSTEE4X21/2	4" x 4" x 2-1/2"	Press x Press x Press
PRESSTEE4X3	4" x 4" x 3"	Press x Press x Press

COPPER PRESS FITTINGS

Male Adapter



. Adapts copper to standard male pipe thread

Part No#	Size	Type
PRESSMIPADPT1/2	1/2"	Press x MPT
PRESSMIPADPT3/4	3/4"	Press x MPT
PRESSMIPADPT1	1"	Press x MPT
PRESSMIPADPT11/4	1-1/4"	Press x MPT
PRESSMIPADPT11/2	1-1/2"	Press x MPT
PRESSMIPADPT2	2"	Press x MPT
PRESSMIPADPT21/2	2-1/2"	Press x MPT
PRESSMIPADPT3	3"	Press x MPT

Female Adapter



. Adapts copper to standard female pipe thread

Part No#	Size	Type
PRESSFIPADPT1/2	1/2"	Press x FPT
PRESSFIPADPT3/4	3/4"	Press x FPT
PRESSFIPADPT1	1"	Press x FPT
PRESSFIPADPT11/4	1-1/4"	Press x FPT
PRESSFIPADPT11/2	1-1/2"	Press x FPT
PRESSFIPADPT2	2"	Press x FPT

Cap



. Used to cap off copper pipe

Part No#	Size	Type
PRESSCAP1/2	1/2"	Press
PRESSCAP3/4	3/4"	Press
PRESSCAP1	1"	Press
PRESSCAP11/4	1-1/4"	Press
PRESSCAP11/2	1-1/2"	Press
PRESSCAP2	2"	Press
PRESSCAP21/2	2-1/2"	Press
PRESSCAP3	3"	Press
PRESSCAP4	4"	Press

Union



. Used to join straight lengths of pipe together for easy removal

Part No#	Size	Type
PRESSUNION1/2	1/2"	Press x Press
PRESSUNION3/4	3/4"	Press x Press
PRESSUNION1	1"	Press x Press
PRESSUNION11/4	1-1/4"	Press x Press
PRESSUNION11/2	1-1/2"	Press x Press
PRESSUNION2	2"	Press x Press

Copper Press Dielectric Union



. Must be used when connecting copper to galvanized pipe to avoid electrolysis of dissimilar metals

. Zinc plated steel

. Includes rubber gasket

. Lead free

Part No#	Size	Type
LEG1/2PRESSDIELECTRI	1/2"	Press x FPT
LEG3/4PRESSDIELECTRI	3/4"	Press x FPT
LEG1PRESSDIELECTRIC	1"	Press x FPT
LEG11/4PRESSDIELECTR	1-1/4"	Press x FPT
LEG11/2PRESSDIELECTR	1-1/2"	Press x FPT
LEG2PRESSDIELECTRIC	2"	Press x FPT

Copper Press Male Union



. Adapts copper to standard male threads

. Easy to remove union design

Part No#	Size	Type
LEG1/2PRESSXMIPUNION	1/2"	Press x MPT
LEG3/4PRESSXMIPUNION	3/4"	Press x MPT

Copper Press Female Union



. Adapts copper to standard female threads

. Easy to remove union design

Part No#	Size	Type
LEG1/2PRESSXFIPUNION	1/2"	Press x FPT
LEG3/4PRESSXFIPUNION	3/4"	Press x FPT

COPPER PRESS FITTINGS

Coupling With Stop



. Used to join straight lengths of pipe together

Part No#	Size	Type
PRESSCOUP1/2	1/2"	Press x Press
PRESSCOUP3/4	3/4"	Press x Press
PRESSCOUP1	1"	Press x Press
PRESSCOUP11/4	1-1/4"	Press x Press
PRESSCOUP11/2	1-1/2"	Press x Press
PRESSCOUP2	2"	Press x Press
PRESSCOUP21/2	2-1/2"	Press x Press
PRESSCOUP3	3"	Press x Press
PRESSCOUP4	4"	Press x Press

Coupling Less Stop



. Used to slip over copper pipe to join two lengths together

. May also be called a "slip coupling" or "repair coupling"

Part No#	Size	Type
PRESSSLIPCOUP1/2	1/2"	Press x Press
PRESSSLIPCOUP3/4	3/4"	Press x Press
PRESSSLIPCOUP1	1"	Press x Press
PRESSSLIPCOUP11/4	1-1/4"	Press x Press
PRESSSLIPCOUP11/2	1-1/2"	Press x Press
PRESSSLIPCOUP2	2"	Press x Press
PRESSSLIPCOUP21/2	2-1/2"	Press x Press
PRESSSLIPCOUP3	3"	Press x Press
PRESSSLIPCOUP4	4"	Press x Press

Reducing Coupling



. Used to reduce and join straight lengths of pipe together

Part No#	Size	Type
PRESSCOUP3/4X1/2	3/4" x 1/2"	Press x Press
PRESSCOUP1X1/2	1" x 1/2"	Press x Press
PRESSCOUP1X3/4	1" x 3/4"	Press x Press
PRESSCOUP11/4X3/4	1-1/4" x 3/4"	Press x Press
PRESSCOUP11/4X1	1-1/4" x 1"	Press x Press
PRESSCOUP11/2X3/4	1-1/2" x 3/4"	Press x Press
PRESSCOUP11/2X1	1-1/2" x 1"	Press x Press
PRESSCOUP11/2X11/4	1-1/2" x 1-1/4"	Press x Press
PRESSCOUP2X3/4	2" x 3/4"	Press x Press
PRESSCOUP2X1	2" x 1"	Press x Press
PRESSCOUP2X11/4	2" x 1-1/4"	Press x Press
PRESSCOUP2X11/2	2" x 1-1/2"	Press x Press
PRESSCOUP21/2X1	2-1/2" x 1"	Press x Press
PRESSCOUP21/2X2	2-1/2" x 2"	Press x Press
PRESSCOUP3X2	3" x 2"	Press x Press
PRESSCOUP3X21/2	3" x 2-1/2"	Press x Press
PRESSCOUP4X3	4" x 3"	Press x Press

COPPER PRESS FITTINGS

Fitting Reducer



. Used to fit into the hub of a fitting to reduce it down

Part No#	Size	Type
PRESSFTGRED3/4X1/2	3/4" x 1/2"	FTG x Press
PRESSFTGRED1X1/2	1" x 1/2"	FTG x Press
PRESSFTGRED1X3/4	1" x 3/4"	FTG x Press
PRESSFTGRED11/4X1/2	1-1/4" x 1/2"	FTG x Press
PRESSFTGRED11/4X3/4	1-1/4" x 3/4"	FTG x Press
PRESSFTGRED11/4X1	1-1/4" x 1"	FTG x Press
PRESSFTGRED11/2X3/4	1-1/2" x 3/4"	FTG x Press
PRESSFTGRED11/2X1	1-1/2" x 1"	FTG x Press
PRESSFTGRED11/2X11/4	1-1/2" x 1-1/4"	FTG x Press
PRESSFTGRED2X1/2	2" x 1/2"	FTG x Press
PRESSFTGRED2X3/4	2" x 3/4"	FTG x Press
PRESSFTGRED2X1	2" x 1"	FTG x Press
PRESSFTGRED2X11/4	2" x 1-1/4"	FTG x Press
PRESSFTGRED2X11/2	2" x 1-1/2"	FTG x Press
PRESSFTGRED21/2X3/4	2-1/2" x 3/4"	FTG x Press
PRESSFTGRED21/2X1	2-1/2" x 1"	FTG x Press
PRESSFTGRED21/2X11/4	2-1/2" x 1-1/4"	FTG x Press
PRESSFTGRED21/2X11/2	2-1/2" x 1-1/2"	FTG x Press
PRESSFTGRED21/2X2	2-1/2" x 2"	FTG x Press
PRESSFTGRED3X3/4	3" x 3/4"	FTG x Press
PRESSFTGRED3X11/2	3" x 1-1/2"	FTG x Press
PRESSFTGRED3X2	3" x 2"	FTG x Press
PRESSFTGRED3X21/2	3" x 2-1/2"	FTG x Press
PRESSFTGRED4X3	4" x 3"	FTG x Press

Copper Press x PEX Adapter



. Adapts copper press to PEX piping

. Lead free

Part No#	Size	Type
LEG1/2PRESSXPEXADPT	1/2"	Press x PEX
LEG3/4PRESSXPEXADPT	3/4"	Press x PEX
LEG1PRESSXPEXADPT	1"	Press x PEX

Copper Press Swing Check Valve



. Lead free

. Can be used for both horizontal and vertical installation

Part No#	Size	Type
LEG1/2PRESSSWINGCHEC	1/2"	Press x Press
LEG3/4PRESSSWINGCHEC	3/4"	Press x Press
LEG1PRESSSWINGCHECK	1"	Press x Press

Copper Press Spring Check Valve

PRESS



. Lead free

. Can be used for both horizontal and vertical installation

Part No#	Size	Type
LEG1/2PRESSSPRINGCHE	1/2"	Press x Press
LEG3/4PRESSSPRINGCHE	3/4"	Press x Press
LEG1PRESSSPRINGCHECK	1"	Press x Press

Copper Press Dielectric Flange

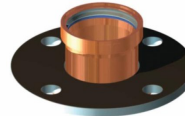

. Companion style flange for copper press connection

Part No#	Size	Type
PRESSFLANGE21/2	2-1/2"	Press
PRESSFLANGE3	3"	Press
PRESSFLANGE4	4"	Press

COPPER PRESS FITTINGS

Copper Press Full Port Ball Valve



- . Full port lever handle
- . Not approved for gas, WATER ONLY!

Part No#	Size	Type
LEG1/2PRESSBALLVALVE	1/2"	Press x Press
LEG3/4PRESSBALLVALVE	3/4"	Press x Press
LEG1PRESSBALLVALVE	1"	Press x Press
LEG11/4PRESSBALLVALVE	1-1/4"	Press x Press
LEG11/2PRESSBALLVALVE	1-1/2"	Press x Press
LEG2PRESSBALLVALVE	2"	Press x Press
LEG21/2PRESSBALLVALVE	2-1/2"	Press x Press
LEG3PRESSBALLVALVE	3"	Press x Press
LEG4PRESSBALLVALVE	4"	Press x Press

Copper Press Full Port Ball Valve With Drain



- . Full port lever handle
- . Not approved for gas, WATER ONLY!
- . Includes 1/8 drain port with cap

Part No#	Size	Type
LEG1/2PRESSBALLW/DRA	1/2"	Press x Press
LEG3/4PRESSBALLW/DRA	3/4"	Press x Press
LEG1PRESSBALLW/DRAIN	1"	Press x Press

Copper Press 1/4 Turn Boiler Drain Valve



- . Lead free
- . Convenient 1/4 turn style handle
- . Connects directly to copper press

Part No#	Size	Type
LEG1/2PRESS1/4TURNBO	1/2"	Press X MHT
LEG3/4PRESS1/4TURNBO	3/4"	Press X MHT

Copper Press Supply Valves



- . Chrome finish
- . 1/4 turn handle

Part No#	Size	Type
LEG1/2X3/8PRESSANGLE	1/2" Press x 3/8" Comp	Angle
LEG1/2X3/8PRESSSTRST	1/2" Press x 3/8" Comp	Straight
LEG1/2X1/4PRESSANGLE	1/2" Press x 1/4" Comp	Angle

Copper Press Tool Rental

Part No#	Description	Price
MILMHP100	Tool & Jaw Kit: 1/2" - 2"	\$65.00/24 Hours
MILMHP300	Jaw Kit: 2-1/2" - 4"	\$52.00/24 Hours



RUBBER COUPLINGS

Rubber Coupling (PL/CI x PL/CI)



- . Standard rubber coupling
- . To be used with both cast iron no hub or PVC DWV piping
- . To not be used for underground purposes, above only
- . **Note: 1-1/2" x 1-1/4" rubber coupling and 1-1/4" rubber coupling will accept 1-1/4" PVC DWV and 1-1/2" plastic tubular piping**

Part No#	Size	Type
MIS11/4COUP	1-1/4" (Note Above)	(PL/CI x PL/CI)
MIS11/2COUP	1-1/2"	(PL/CI x PL/CI)
MIS2COUP	2"	(PL/CI x PL/CI)
MIS3COUP	3"	(PL/CI x PL/CI)
MIS4COUP	4"	(PL/CI x PL/CI)
MIS5COUP	5"	(PL/CI x PL/CI)
MIS6COUP	6"	(PL/CI x PL/CI)
MIS8COUP	8"	(PL/CI x PL/CI)
MIS10COUP	10"	(PL/CI x PL/CI)
MIS12COUP	12"	(PL/CI x PL/CI)
MIS11/2X11/4COUP	1-1/2" x 1-1/4" (Note Above)	(PL/CI x PL/CI)
MIS2X11/2COUP	2" x 1-1/2"	(PL/CI x PL/CI)
MIS3X2COUP	3" x 2"	(PL/CI x PL/CI)
MIS4X2COUP	4" x 2"	(PL/CI x PL/CI)
MIS4X3COUP	4" x 3"	(PL/CI x PL/CI)
MIS6X4COUP	6" x 4"	(PL/CI x PL/CI)
MIS8X6COUP	8" x 6"	(PL/CI x PL/CI)
MIS10X8COUP	10" x 8"	(PL/CI x PL/CI)

Rubber ARC Coupling (PL/CI x PL/CI)



- . Heavy duty rubber coupling with metal shield
- . To be used with both cast iron no hub or PVC DWV piping
- . Approved for underground applications

Part No#	Size	Type
MIS11/2HDARC	1-1/2"	(PL/CI x PL/CI)
MIS2HDARC	2"	(PL/CI x PL/CI)
MIS3HDARC	3"	(PL/CI x PL/CI)
MIS4HDARC	4"	(PL/CI x PL/CI)
MIS6HDARC	6"	(PL/CI x PL/CI)
MIS8HDARC	8"	(PL/CI x PL/CI)
MIS6X4PLXPLHDARC	6" x 4"	(PL/CI x PL/CI)

Rubber Coupling (Clay x PL/CI)



- . Standard rubber coupling
- . Adapts from clay piping to no hub cast iron or PVC DWV piping

Part No#	Size	Type
MIS4X4CLAYXPL	4"	(CLAY x PL/CI)
MIS6X6CLAYXPL	6"	(CLAY x PL/CI)
MIS8X8CLAYXPL	8"	(CLAY x PL/CI)
MIS6X4CLAYXPL	6" x 4"	(CLAY x PL/CI)

Rubber ARC Coupling (CLAY x PL/CI)



- . Heavy duty rubber coupling with metal shield
- . Adapts from clay piping to no hub cast iron or PVC DWV piping
- . Approved for underground applications

Part No#	Size	Type
MIS4X4CLXPLHDARC	4"	(CLAY x PL/CI)
MIS6X6CLXPLHDARC	6"	(CLAY x PL/CI)
MIS8X8CLXPLHDARC	8"	(CLAY x PL/CI)
MIS6X4CLXPLHDARC	6" x 4"	(CLAY x PL/CI)

No Hub Coupling (PL/CI x PL/CI)



- . Used to join two lengths of no hub cast iron pipe together
- . Can also be used with a PVC no hub adapter to adapt to PVC DWV piping
- . Ridged stainless steel band

Part No#	Size	Type
MISNHCOUP11/2	1-1/2"	(PL/CI x PL/CI)
MISNHCOUP2	2"	(PL/CI x PL/CI)
MISNHCOUP3	3"	(PL/CI x PL/CI)
MISNHCOUP4	4"	(PL/CI x PL/CI)
MISNHCOUP5	5"	(PL/CI x PL/CI)
MISNHCOUP6	6"	(PL/CI x PL/CI)
MISNHCOUP8	8"	(PL/CI x PL/CI)
MISNHCOUP2X11/2	2" x 1-1/2"	(PL/CI x PL/CI)

RUBBER COUPLINGS

Rubber ARC Coupling (PL/CI x Copper)



- . Heavy duty rubber coupling with metal shield
- . Adapts copper piping to no hub cast iron or PVC DWV piping

Part No#	Size	Type
MIS11/2COPPERXPL	1-1/2"	(C x PL/CI)
MIS2COPPERXPL	2"	(C x PL/CI)
MISPK33	3"	(C x PL/CI)
MISPK44	4"	(C x PL/CI)
MIS11/2x2COPXPL	1-1/2" X 2"	(C x PL/CI)

Sewer Saddle Tap



- . TF-400 - Adapts 4" PVC DWV to any main from 6" - 15"
- . TF-600 - Adapts 6" PVC DWV to any main from 8" - 21"
- . Kit includes 3 hose clamps, stainless steel apron, and rubber gasket connector

Part No#	Size	Type
MIS4SADDLETAP	4"	PVC DWV
MIS6SADDLETAP	6"	PVC DWV

Service Weight Hub Gasket



- . Fits inside Service Weight hub and adapts to PVC DWV piping
- . Thick rubber gasket

Part No#	Size	Type
EVE3MULTITITEGASKET	3" x 3"	SW x PVC/CI
EVE4MULTITITEGASKET	4" x 4"	SW x PVC/CI

No Hub Torque Wrench



- . 5/16" socket size
- . Built in reversing lever
- . Ratchets one way

Part No#	Description	Size
PASN/HTORQUEWRENCH	No Hub Torque Wrench	5/16"

Stainless Steel Hose Clamps



- . Stainless steel hose clamps with 5/16" nut driver head
- . 1/2" diameter bands
- . #12 hose clamp is most common for dishwashers

Part No#	Size	Sell Qty
EMCHOSECLAMP4	7/32"-5/8"	Each
EMCHOSECLAMP6	3/8"-7/8"	Each
EMCHOSECLAMP10	7/16"-1"	Each
EMCHOSECLAMP12	9/16"-1-1/4"	Each
EMCHOSECLAMP16	11/16"-1-1/2"	Each
EMCHOSECLAMP20	3/4"-1-3/4"	Each
EMCHOSECLAMP24	1-1/16"-2"	Each
EMCHOSECLAMP36	1-13/16"-2-3/4"	Each

CAST IRON NO HUB FITTINGS

90 Degree Elbow



. Used To change direction in piping

Part No#	Size	Type
NH1/4BEND2	2"	NH x NH
NH1/4BEND3	3"	NH x NH
NH1/4BEND4	4"	NH x NH
NH1/4BEND5	5"	NH x NH
NH1/4BEND6	6"	NH x NH
NH1/4BEND8	8"	NH x NH

90 Degree Tapped Elbow



. 90 degree elbow adapts no hub to standard female pipe threads

Part No#	Size	Type
NHTAP1/4BEND2X2	2"	NH x FPT
NHTAPPEDADAPT2x11/2	2" x 1-1/2"	NH x FPT

90 Degree Long Turn Elbow



. Used to change direction in piping

Part No#	Size	Type
NHLONG1/4BEND2	2"	NH x NH
NHLONG1/4BEND3	3"	NH x NH
NHLONG1/4BEND4	4"	NH x NH

45 Degree Elbow



. Used to change direction in piping

Part No#	Size	Type
NH1/8BEND2	2"	NH x NH
NH1/8BEND3	3"	NH x NH
NH1/8BEND4	4"	NH x NH
NH1/8BEND5	5"	NH x NH
NH1/8BEND6	6"	NH x NH
NH1/8BEND8	8"	NH x NH

22 1/2 Degree Elbow



. Used to change direction in piping

Part No#	Size	Type
NH1/16BEND2	2"	NH x NH
NH1/16BEND3	3"	NH x NH
NH1/16BEND4	4"	NH x NH
NH1/16BEND5	5"	NH x NH
NH1/16BEND6	6"	NH x NH
NH1/16BEND8	8"	NH x NH

60 Degree Elbow



. Used to change direction in piping

Part No#	Size	Type
NH1/6BEND2	2"	NH x NH
NH1/6BEND3	3"	NH x NH
NH1/6BEND4	4"	NH x NH

Wye



. Used to connect branch line to horizontal drain line

Part No#	Size	Type
NHWYE2	2"	NH x NH x NH
NHWYE3	3"	NH x NH x NH
NHWYE4	4"	NH x NH x NH
NHWYE5	5"	NH x NH x NH
NHWYE6	6"	NH x NH x NH
NHWYE8	8"	NH x NH x NH

CAST IRON NO HUB FITTINGS

Reducing Wye



. Used to connect branch line to horizontal drain line

Part No#	Size	Type
NHWYE3X2	3" x 3" x 2"	NH x NH x NH
NHWYE4X2	4" x 4" x 2"	NH x NH x NH
NHWYE4X3	4" x 4" x 3"	NH x NH x NH
NHWYE5X3	5" x 5" x 3"	NH x NH x NH
NHWYE5X4	5" x 5" x 4"	NH x NH x NH
NHWYE6X3	6" x 6" x 3"	NH x NH x NH
NHWYE6X4	6" x 6" x 4"	NH x NH x NH
NHWYE6X5	6" x 6" x 5"	NH x NH x NH
NHWYE8X4	8" x 8" x 4"	NH x NH x NH
NHWYE8X6	8" x 8" x 6"	NH x NH x NH

Tapped Wye



. Used to connect branch line to horizontal drain line

. Adapts to standard female pipe threads on branch line

Part No#	Size	Type
NHTAPPEDWYE2x11/2	2" x 2" x 1-1/2"	NH x NH x FPT
NHTAPPEDWYE2x2	2"	NH x NH x FPT
NHTAPPEDWYE3x11/2	3" x 3" x 1-1/2"	NH x NH x FPT
NHTAPPEDWYE3X2	3" x 3" x 2"	NH x NH x FPT
NHTAPPEDWYE4X11/2	4" x 4" x 1-1/2"	NH x NH x FPT
NHTAPPEDWYE4X2	4" x 4" x 2"	NH x NH x FPT

Double Wye



. Used to connect two branch lines into a horizontal drain line

Part No#	Size	Type
NHDBLWYE2	2"	NH x NH x NH x NH
NHDBLWYE3	3"	NH x NH x NH x NH
NHDBLWYE4	4"	NH x NH x NH x NH

Reducing Double Wye



. Used to connect two branch lines into a horizontal drain line

Part No#	Size	Type
NHDBLWYE3X2	3" x 3" x 2" x 2"	NH x NH x NH x NH
NHDBLWYE4X2	4" x 4" x 2" x 2"	NH x NH x NH x NH
NHDBLWYE4X3	4" x 4" x 3" x 3"	NH x NH x NH x NH

Sanitary Tee



. Used to connect a branch line into a vertical branch line

Part No#	Size	Type
NHSANTEEE2	2"	NH x NH x NH
NHSANTEEE3	3"	NH x NH x NH
NHSANTEEE4	4"	NH x NH x NH
NHSANTEEE5	5"	NH x NH x NH
NHSANTEEE6	6"	NH x NH x NH

Reducing Sanitary Tee



. Used to connect a branch line into a vertical branch line

Part No#	Size	Type
NHSANTEEE3x2	3" x 3" x 2"	NH x NH x NH
NHSANTEEE4x2	4" x 4" x 2"	NH x NH x NH
NHSANTEEE4x3	4" x 4" x 3"	NH x NH x NH

Tapped Tee



. Used to connect a branch line into a vertical branch line

. Adapts to standard female pipe threads on branch line

Part No#	Size	Type
NHTAPPEDTEE2x11/2	2" x 2" x 1-1/2"	NH x NH x FPT
NHTAPPEDTEE2x2	2"	NH x NH x FPT
NHTAPPEDTEE3X11/2	3" x 1-1/2"	NH x NH x FPT
NHTAPPEDTEE3X2	3" x 2"	NH x NH x FPT
NHTAPPEDTEE4X11/2	4" x 1-1/2"	NH x NH x FPT
NHTAPPEDTEE4x2	4" x 2"	NH x NH x FPT

CAST IRON NO HUB FITTINGS

Double Sanitary Cross



. Used to connect two branch lines into a vertical branch line

Part No#	Size	Type
NHSANCROSS2	2"	NH x NH x NH x NH
NHSANCROSS3	3"	NH x NH x NH x NH
NHSANCROSS4	4"	NH x NH x NH x NH

Reducing Double Sanitary Cross



. Used to connect two branch lines into a vertical branch line

Part No#	Size	Type
NHSANCROSS3X2	3" x 3" x 2" x 2"	NH x NH x NH x NH
NHSANCROSS4X2	4" x 4" x 2" x 2"	NH x NH x NH x NH
NHSANCROSS4X3	4" x 4" x 3" x 3"	NH x NH x NH x NH

Tapped Sanitary Cross



. Used to connect two branch lines into a vertical branch line
 . Adapts to standard female pipe threads on branch lines

Part No#	Size	Type
NHTAPPEDCROSS2x11/2	2" x 2" x 1-1/2" x 1-1/2"	NH x NH x FPT x FPT
NHTAPPEDCROSS2x2	2"	NH x NH x FPT x FPT
NHTAPPEDCROSS3x11/2	3" x 3" x 1-1/2" x 1-1/2"	NH x NH x FPT x FPT
NHTAPPEDCROSS3x2	3" x 3" x 2" x 2"	NH x NH x FPT x FPT
NHTAPPEDCROSS4x11/2	4" x 4" x 1-1/2" x 1-1/2"	NH x NH x FPT x FPT
NHTAPPEDCROSS4x2	4" x 4" x 2" x 2"	NH x NH x FPT x FPT

Cleanout Tee Less Plug



. Used with a threaded plug to provide a cleanout opening

Part No#	Size	Type
NHC/OTEE2	2"	NH x NH x FPT
NHC/OTEE3	3"	NH x NH x FPT
NHC/OTEE4	4"	NH x NH x FPT
NHC/OTEE5	5"	NH x NH x FPT
NHC/OTEE6	6"	NH x NH x FPT
NHC/OTEE8	8"	NH x NH x FPT

Tapped Adapter



. Adapts no hub pipe to a threaded fitting

Part No#	Size	Type
NHTAPPEDADAPT2x11/2	2" x 1-1/2"	NH x FPT
NHTAPPEDADAPT2x2	2"	NH x FPT
NHTAPPEDADAPT3x2	3" x 2"	NH x FPT

Cleanout Ferrule Less Plug



. Cleanout housing for no hub pipe

Part No#	Size	Type
NHFERRULE3	3"	NH x FPT
NHFERRULE4	4"	NH x FPT
NHFERRULE5	5"	NH x FPT
NHFERRULE6	6"	NH x FPT

Blind Plug



. Used to cap off no hub pipe

Part No#	Size	Type
NHBLINDPLUG2	2"	NH
NHBLINDPLUG3	3"	NH
NHBLINDPLUG4	4"	NH
NHBLINDPLUG5	5"	NH
NHBLINDPLUG6	6"	NH
NHBLINDPLUG8	8"	NH

Running P-Trap



. Used to trap sewer gases from entering a drain line

Part No#	Size	Type
NHRUNNINGTRAP4	4"	NH x NH x NH

CAST IRON NO HUB FITTINGS/LEADING TOOLS

Standard P-Trap



. Used to trap sewer gases from entering a drain line

Part No#	Size	Type
NHPTRAP2	2"	NH x NH
NHPTRAP3	3"	NH x NH
NHPTRAP4	4"	NH x NH

Short Reducer



. Used to reduce or increase pipe sizes

Part No#	Size	Type
NHSHORTRED3X2	3" x 2"	NH x NH
NHSHORTRED4X2	4" x 2"	NH x NH
NHSHORTRED4X3	4" x 3"	NH x NH
NHSHORTRED5X3	5" x 3"	NH x NH
NHSHORTRED5X4	5" x 4"	NH x NH
NHSHORTRED6X3	6" x 3"	NH x NH
NHSHORTRED6X4	6" x 4"	NH x NH
NHSHORTRED6X5	6" x 5"	NH x NH
NHSHORTRED8X4	8" x 4"	NH x NH
NHSHORTRED8X6	8" x 6"	NH x NH

Lead Ingot Puck



. 5 lb. lead puck for leading joints
. Sold individual or pack of 5

Part No#	Size	Type
JON5#CAULKLEAD	5 lb.	Lead

Bag Of Brown Oakum



. 1 lb. bag contains 4 strands
. Oil covered
. Used for lead joints

Part No#	Size	Type
PASOAKUMBAG	1 lb.	Oakum

Lead Pouring Ladle



. 4" lead pouring ladle
. Steel construction

Part No#	Size	Type
WAL4LEADLADLE	4"	Steel

Lead Melting Pot



. 8" lead melting pot

Part No#	Size	Type
WAL8MELTINGPOT	8"	Cast Iron

Lead Caulking Tools



. Lead tools for packing oakum at lead joints

Part No#	Size	Type
WALINSIDCAULKTOOL	5/8" x 7"	Inside Lead Tool
WALOUTSIDCAULKTOOL	5/8" x 7"	Outside Lead Tool

Plastic Seal Cartridge



. Seals soil pipe joints together
. Waterproof
. Will not shrink or crack

Part No#	Description	Size
OATPLASTICSEALCART	Plastic Seal Cartridge	10.3 oz.

Inside Caulk Cast Iron Closet Flange



. Connects to no hub cast iron pipe using lead

Part No#	Size	Type
JON4x1CICLOSETFLG	4" x 1"	SPG/Lead
JON4x11/2CICLOSETFLG	4" x 1-1/2"	SPG/Lead
JON4x2CICLOSETFLG	4" x 2"	SPG/Lead
JON4x21/2CICLOSETFLG	4" x 2-1/2"	SPG/Lead
JON4x3CICLOSETFLG	4" x 3"	SPG/Lead
JON4x4CICLOSETFLG	4" x 4"	SPG/Lead
JON4x6CICLOSETFLG	4" x 6"	SPG/Lead

No Hub Cast Iron Closet Flange



. Connects directly to no hub cast iron pipe using a no hub coupling

Part No#	Size	Type
JON3x51/2N/HFLG	3" x 5-1/2"	NH
JON4x51/2N/HFLG	4" x 5-1/2"	NH

Offset Cast Iron Closet Flange



. 2" offset

Part No#	Size	Type
JON4x2CIOFFSETFLG	4" x 2"	SPG/Lead

Code Blue No Caulk Closet Flange



. No caulk or lead required
 . Includes 4 stainless steel bolts and nuts
 . Pushes directly over cast iron no hub or PVC DWV piping
 . Easy installation

Part No#	Size	Type
JON4x2QUICKSETFLG	4" x 2"	H

Twist N' Set Closet Flange



. Pushes directly inside cast iron no hub or PVC DWV piping
 . Rubber gasket guarantees seal

Part No#	Size	Type
OATPVCTWISTFLANGE3	3"	SPG
OATPVCTWISTFLANGE4	4"	SPG

J-Tech Closet Flange



. Fits inside 4" cast iron no hub or PVC DWV pipe
 . Includes hex key bolts that tighten and expand gasket for a tight seal

Part No#	Size	Type
BRUJTECKREPFLG	4"	SPG

Standard PVC Closet Flange With Knockout



. Fits inside 4" PVC pipe or over 3" PVC pipe
 . Includes knockout

Part No#	Size	Type
SIOPVCSLABFLG	4" x 3"	SPG/H

Schedule 30 PVC Closet Flange With Knockout



. Fits directly over schedule 30 PVC piping
 . Includes knockout

Part No#	Size	Type
SIOPVCSLABFLG3SCH30	3"	H

3" Inside Pipe Closet Flange With O-Rings

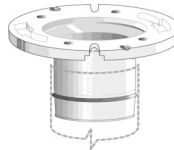

. Pushes directly into 3" PVC piping
 . Includes two O-rings: Large O-ring fits into 3" PVC DWV and small O-ring fits into 3" schedule 30 PVC

Part No#	Size	Type
BRUPIPEFITFLG3	3"	SPG

3" Inside Pipe Closet Flange With Metal Ring



. Fits directly inside 3" PVC DWV piping
 . Includes metal ring for stronger surface
 . Includes knockout

Part No#	Size	Type
SIOPIPEFITSLABFLG3	3"	SPG

3" Long Inside Pipe Closet Flange

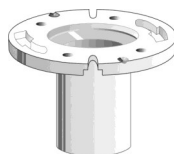

. Fits directly inside 3" PVC DWV piping
 . Longer flange provides more space for a better solvent joint

Part No#	Size	Type
BRULONGFLG3	3"	SPG

CLOSET FLANGES & REPAIR

3" Hub Fit Closet Flange

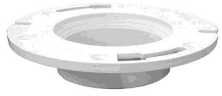

- . Fits directly into 3" PVC DWV hub
- . Less knockout

Part No#	Size	Type
OAT3HUBFITFLG	3"	Inside Hub

4" x 3" PVC Long Closet Flange



- . Fits inside 4" PVC pipe or over 3" PVC pipe
- . Longer flange provides more space for a better solvent joint
- . Less knockout

Part No#	Size	Type
BRULONGFLG4X3	4" x 3"	SPG/HUB

Standard Closet Flange With Metal Ring



- . Fits inside 4" PVC pipe or over 3" PVC pipe
- . Includes metal ring for stronger surface
- . Less knockout

Part No#	Size	Type
SIOPVCSLABFLGW/RING	4" x 3"	SPG/HUB

PVC Offset Closet Flange With Metal Ring



- . Fits inside 4" PVC pipe or over 3" PVC pipe
- . Includes metal ring for stronger surface
- . Less knockout

Part No#	Size	Type
SIOPVCOFFSETFLGW/RING	4" x 3"	SPG/HUB

4-Way PVC Offset Closet Flange



- . Fits inside 4" PVC pipe or over 3" PVC pipe
- . 2" offset
- . Less knockout

Part No#	Size	Type
JON4X3OFFSETFLG	4" x 3"	SPG/HUB

45 Degree Swivel PVC Offset Closet Flange



- . Plastic swivel ring
- . 45 degree offset for tight spaces
- . Fits inside 4" PVC pipe or over 3" PVC pipe
- . Less knockout

Part No#	Size	Type
OAT4x3OFFSETFLG45	4" x 3"	SPG/HUB

PVC Urinal Flange



- . Kit Includes PVC urinal flange, rubber gasket & bolt kit

Part No#	Size	Type
OATFEMURINALFLG	2"	H (Female)
OATMAEURINALFLG	2"	SPG (Male)

Closet Flange Spacer



- . Used to raise a closet flange to accommodate the height of a new floor

Part No#	Size	Type
BRUSPACERFLG1/4	1/4"	PVC
WALFLANGESPACER	1/2"	PVC

Spanner Repair Flange



- . Moon style spanner flange repairs broken plastic or cast iron closet flanges

Part No#	Description	Type
JONSPANNERFLG	Spanner Flange	Steel

Pasco Quick Closet Flange Repair Ring



- . Unique design goes underneath broken flange to create a new mounting surface

Part No#	Description	Type
PASQUICKRING	Quick Ring	Steel

Harvey Closet Flange Repair Ring



- . Split design repair ring fits around existing flange

Part No#	Description	Type
HARREPAIRRING	Harvey Repair Ring	Metal

Closet Flange Support Kit



- . Large metal base creates new surface to mount a closet flange

Part No#	Description	Type
WALCLOSETFLGSUPPORT	Closet Flange Support Kit	Steel

PVC DWV FITTINGS

90 Degree Elbow



- . Used to change direction in piping
- . May also be called a "1/4 bend"

Part No#	Size	Type
PVCELL11/2	1-1/2"	H x H
PVCELL2	2"	H x H
PVCELL3	3"	H x H
PVCELL4	4"	H x H
PVCELL6	6"	H x H
PVCELL8	8"	H x H
PVCELL10	10"	H x H

90 Degree Street Elbow



- . Used to change direction in piping
- . May also be called a "street 1/4 bend"

Part No#	Size	Type
PVCSTELL11/2	1-1/2"	SPG x H
PVCSTELL2	2"	SPG x H
PVCSTELL3	3"	SPG x H
PVCSTELL4	4"	SPG x H
PVCSTELL6	6"	SPG x H
PVCSTELL8	8"	SPG x H

90 Degree Reducing Elbow



- . Used to change direction in piping
- . May also be called a "reducing 1/4 bend"
- . 4 x 3 elbow also called a "closet bend"

Part No#	Size	Type
PVCELL2X11/2	2" x 1-1/2"	H x H
PVCELL4X3	4" x 3"	H x H

90 Degree Street Reducing Elbow



- . Usually used for a closet flange under a toilet
- . May also be called a "street closet bend"

Part No#	Size	Type
PVCSTELL4X3	4" x 3"	SPG x H

90 Degree Short Turn Street Elbow



- . Used to change direction in piping in tight spaces
- . May also be called a "trap elbow"

Part No#	Size	Type
PVCVENTELL2	2"	SPG x H
PVCVENTELL3	3"	SPG x H

90 Degree Twin Elbow



- . Used for "back to back" sinks

Part No#	Size	Type
PVCTWINELL11/2	1-1/2"	H x H x H
PVCTWINELL2	2"	H x H x H
PVCTWINELL2X11/2	2" x 1-1/2"	H x H x H

90 Degree Long Sweep Elbow



- . Used to change direction in piping
- . May also be called a "long turn 1/4 bend"

Part No#	Size	Type
PVCL/SELL11/2	1-1/2"	H x H
PVCL/SELL2	2"	H x H
PVCL/SELL3	3"	H x H
PVCL/SELL4	4"	H x H

45 Degree Elbow



- . Used to change direction in piping
- . May also be called a "1/8 bend"

Part No#	Size	Type
PVC4511/2	1-1/2"	H x H
PVC452	2"	H x H
PVC453	3"	H x H
PVC454	4"	H x H
PVC456	6"	H x H
PVC458	8"	H x H
PVC4510	10"	H x H

PVC DWV FITTINGS

45 Degree Street Elbow



- . Used to change direction in piping
- . May also be called a "street 1/8 bend"

Part No#	Size	Type
PVCST4511/2	1-1/2"	SPG x H
PVCST452	2"	SPG x H
PVCST453	3"	SPG x H
PVCST454	4"	SPG x H
PVCST456	6"	SPG x H
PVCST458	8"	SPG x H

22 1/2 Degree Elbow



- . Used to change direction in piping
- . May also be called a "1/16 bend"

Part No#	Size	Type
PVC221/211/2	1-1/2"	H x H
PVC221/22	2"	H x H
PVC221/23	3"	H x H
PVC221/24	4"	H x H
PVC221/26	6"	H x H
PVC221/28	8"	H x H

22-1/2 Degree Street Elbow



- . Used to change direction in piping
- . May also be called a "street 1/16 bend"

Part No#	Size	Type
PVCST221/211/2	1-1/2"	SPG x H
PVCST221/22	2"	SPG x H
PVCST221/23	3"	SPG x H
PVCST221/24	4"	SPG x H
PVCST221/26	6"	SPG x H

60 Degree Elbow



- . Used to change direction in piping
- . May also be called a "1/6 bend"

Part No#	Size	Type
PVC6011/2	1-1/2"	H x H
PVC602	2"	H x H
PVC603	3"	H x H
PVC604	4"	H x H

60 Degree Street Elbow



- . Used to change direction in piping
- . May also be called a "street 1/6 bend"

Part No#	Size	Type
PVCST6011/2	1-1/2"	SPG x H
PVCST602	2"	SPG x H
PVCST603	3"	SPG x H
PVCST604	4"	SPG x H

Wye



- . Used to connect branch line to horizontal drain line

Part No#	Size	Type
PVCWYE11/2	1-1/2"	H x H x H
PVCWYE2	2"	H x H x H
PVCWYE3	3"	H x H x H
PVCWYE4	4"	H x H x H
PVCWYE6	6"	H x H x H
PVCWYE8	8"	H x H x H
PVCWYE10	10"	H x H x H

Reducing Wye



- . Used to connect branch line to horizontal drain line

Part No#	Size	Type
PVCWYE2X11/2	2" x 2" x 1-1/2"	H x H x H
PVCWYE2X11/2X11/2	2" x 1-1/2" x 1-1/2"	H x H x H
PVCWYE3X11/2	3" x 3" x 1-1/2"	H x H x H
PVCWYE3X2	3" x 3" x 2"	H x H x H
PVCWYE4X2	4" x 4" x 2"	H x H x H
PVCWYE4X3	4" x 4" x 3"	H x H x H
PVCWYE6X4	6" x 6" x 4"	H x H x H
PVCWYE8X4	8" x 8" x 4"	H x H x H
PVCWYE8X6	8" x 8" x 6"	H x H x H
PVCWYE10X6	10" x 10" x 6"	H x H x H
PVCWYE10X8	10" x 10" x 8"	H x H x H

PVC DWV FITTINGS

Street Wye



- . Used to connect branch line to horizontal drain line
- . Solvent welds directly into fitting hub

Part No#	Size	Type
PVCSTWYE3	3"	SPG x H x H
PVCSTWYE4	4"	SPG x H x H

Double Wye



- . Used to connect two branch lines into a horizontal drain line

Part No#	Size	Type
PVCDBLWYE11/2	1-1/2"	H x H x H x H
PVCDBLWYE2	2"	H x H x H x H
PVCDBLWYE3	3"	H x H x H x H
PVCDBLWYE4	4"	H x H x H x H

Reducing Double Wye



- . Used to connect two branch lines into a horizontal drain line

Part No#	Size	Type
PVCDBLWYE2X11/2	2" x 2" x 1-1/2" x 1-1/2"	H x H x H x H
PVCDBLWYE3X11/2	3" x 3" x 1-1/2" x 1-1/2"	H x H x H x H
PVCDBLWYE3X2	3" x 3" x 2" x 2"	H x H x H x H
PVCDBLWYE4X2	4" x 4" x 2" x 2"	H x H x H x H
PVCDBLWYE4X3	4" x 4" x 3" x 3"	H x H x H x H

Sanitary Tee



- . Used to connect a branch line into a vertical branch line

Part No#	Size	Type
PVCSANTEE11/2	1-1/2"	H x H x H
PVCSANTEE2	2"	H x H x H
PVCSANTEE3	3"	H x H x H
PVCSANTEE4	4"	H x H x H
PVCSANTEE6	6"	H x H x H
PVCSANTEE8	8"	H x H x H

Reducing Sanitary Tee



- . Used to connect a branch line into a vertical branch line

Part No#	Size	Type
PVCSANTEE2X11/2	2" x 2" x 1-1/2"	H x H x H
PVCSANTEE2X11/2X2	2" x 1-1/2" x 2"	H x H x H
PVCSANTEE2X11/2X11/2	2" x 1-1/2" x 1-1/2"	H x H x H
PVCSANTEE3X11/2	3" x 3" x 1-1/2"	H x H x H
PVCSANTEE3X2	3" x 3" x 2"	H x H x H
PVCSANTEE4X2	4" x 4" x 2"	H x H x H
PVCSANTEE4X3	4" x 4" x 3"	H x H x H

Street Sanitary Tee



- . Used to connect a branch line into a vertical branch line
- . Solvent welds directly into fitting hub

Part No#	Size	Type
PVCSTSANTEE3	3"	SPG x H x H
PVCSTSANTEE4	4"	SPG x H x H

Double Sanitary Tee



- . Used to connect two branch lines into a vertical branch line
- . May also be called a "cross"

Part No#	Size	Type
PVCSANACROSS11/2	1-1/2"	H x H x H x H
PVCSANACROSS2	2"	H x H x H x H
PVCSANACROSS3	3"	H x H x H x H
PVCSANACROSS4	4"	H x H x H x H

Reducing Double Sanitary Tee



- . Used to connect a two branch lines into a vertical branch line
- . May also be called a "cross"

Part No#	Size	Type
PVCSANACROSS2X11/2	2" x 2" x 1-1/2" x 1-1/2"	H x H x H x H
PVCSANACROSS3X11/2	3" x 3" x 1-1/2" x 1-1/2"	H x H x H x H
PVCSANACROSS3X2	3" x 3" x 2" x 2"	H x H x H x H
PVCSANACROSS4X2	4" x 4" x 2" x 2"	H x H x H x H
PVCSANACROSS4X3	4" x 4" x 3" x 3"	H x H x H x H

Sanitary Tee With Right Side Inlet



- . Used to connect a horizontal branch line into a vertical line
- . May also be called a "waste tee"

Part No#	Size	Type
PVCWASTETEERH3X2	3" x 3" x 3" x 2"	H x H x H x H

Sanitary Tee With Left Side Inlet



- . Used to connect a horizontal branch line into a vertical line
- . May also be called a "waste tee"

Part No#	Size	Type
PVCWASTETEELH3X2	3" x 3" x 3" x 2"	H x H x H x H

Sanitary Tee With Left And Right Side Inlet



- . Used to connect two horizontal branch lines into a vertical line
- . May also be called a "waste tee"

Part No#	Size	Type
PVCWASTETEELR3X2	3" x 3" x 3" x 2" x 2"	H x H x H x H x H
PVCWASTETEELR4X2	4" x 4" x 4" x 2" x 2"	H x H x H x H x H

Cleanout Test Tee Less Plug



- . Used with a threaded plug to provide a cleanout opening

Part No#	Size	Type
PVCCOTEE11/2	1-1/2"	H x H x FPT
PVCCOTEE2	2"	H x H x FPT
PVCCOTEE3	3"	H x H x FPT
PVCCOTEE4	4"	H x H x FPT
PVCCOTEE6	6"	H x H x FPT
PVCCOTEE8	8" X 6"	H x H x FPT

Two-Way Cleanout Tee



- . Used as a vertical pipe stack to provide above ground level access to piping

Part No#	Size	Type
PVCTWOWAYC/OTEE3	3"	H x H x H
PVCTWOWAYC/OTEE4	4"	H x H x H

Double Sanitary Tee With Double Inlet



- . Used to connect two horizontal branch lines into a vertical line
- . May also be called a "waste cross"

Part No#	Size	Type
PVCWASTECROSS3X2	3" x 3" x 3" x 3" x 2" x 2"	H x H x H x H x H x H

Male Adapter



- . Adapts PVC to standard male pipe thread

Part No#	Size	Type
PVCMIADPT11/2X11/4	1-1/2" x 1-1/4"	H x MPT
PVCMIADPT11/2	1-1/2"	H x MPT
PVCMIADPT2	2"	H x MPT
PVCMIADPT3	3"	H x MPT
CAN31/2X3ADAPTER	3" x 3-1/2"	H x MPT
PVCMIADPT4	4"	H x MPT
PVCMIADPT6	6"	H x MPT
PVC40MIADPT8	8"	H x MPT

Female Adapter Less Plug



- . Adapts PVC to standard female pipe thread

Part No#	Size	Type
PVCFIPADPT11/2	1-1/2"	H x FPT
PVCFIPADPT2	2"	H x FPT
PVCFIPADPT3	3"	H x FPT
PVCFIPADPT4	4"	H x FPT
PVCFIPADPT6	6"	H x FPT
PVCFIPADPT8	8"	H x FPT

Fitting Cleanout Less Plug



- . Adapts from PVC hub to standard female pipe thread

Part No#	Size	Type
PVCFTGCO11/2	1-1/2"	SPG x FPT
PVCFTGCO2	2"	SPG x FPT
PVCFTGCO3	3"	SPG x FPT
PVCFTGCO4	4"	SPG x FPT
PVCFTGCO6	6"	SPG x FPT

Flush Female Adapter Less Plug



- . Adapts PVC hub to standard female thread
- . Compact design for floor drains & cleanouts

Part No#	Size	Type
SIO842-94P	4"	SPG x FPT

Male Trap Adapter Less Nut And Washer



- . Adapts PVC hub to standard male thread
- . May also be called a "fitting male adapter"

Part No#	Size	Type
PVCMIPFTGADPT11/2	1-1/2"	SPG x MPT
PVCMIPFTGADPT2	2"	SPG x MPT

Female Trap Adapter With Nut And Washer



- . Adapts PVC to tubular slip joint tubular
- . May also be called a "female marvel"

Part No#	Size	Type
PVCMARVEL11/2X11/4F	1-1/2" x 1-1/4"	H x SJT
PVCMARVEL11/2F	1-1/2"	H x SJT

Male Trap Adapter With Nut And Washer



- . Adapts PVC hub to slip joint tubular
- . May also be called a "male marvel"

Part No#	Size	Type
PVCMARVEL11/2X11/4M	1-1/2" X 1-1/4"	SPG x SJT
PVCMARVEL11/2M	1-1/2"	SPG x SJT

Raised Head Cleanout Plug



- . Used to thread into standard female pipe thread

Part No#	Size	Type
PVCRHPLUG11/2	1-1/2"	MPT
PVCRHPLUG2	2"	MPT
IPS21/2PVCRHPLUG	2-1/2"	MPT
PVCRHPLUG3	3"	MPT
IPS31/2PVCRHPLUG	3-1/2"	MPT
PVCRHPLUG4	4"	MPT
PVCRHPLUG6	6"	MPT
PVCRHPLUG8	8"	MPT

Flush Cleanout Plug



- . Used to thread into standard female pipe threads
- . Includes 1/4 tap for a cleanout cover

Part No#	Size	Type
SIOPVCFLUSHPLUG2	2"	MPT
SIOPVCFLUSHPLUG21/2	2-1/2"	MPT
SIOPVCFLUSHPLUG3	3"	MPT
SIOPVCFLUSHPLUG31/2	3-1/2"	MPT
SIOPVCFLUSHPLUG4	4"	MPT
SIOPVCFLUSHPLUG6	6"	MPT

Glue Cap



- . CAPS ARE RATED FOR DWV AND PRESSURE
- . Used to cap off PVC pipe

Part No#	Size	Type
PVCCAP11/2	1-1/2"	H
PVCCAP2	2"	H
PVCCAP3	3"	H
PVCCAP4	4"	H
PVCCAP6	6"	H
PVCCAP8	8"	H
PVCCAP10	10"	H

Glue P-Trap



LOOKING FOR CONDENSATE P-TRAP? CHECK OUT PVC PRESSURE FITTINGS

- . Used to trap sewer gases from entering a drain line

Part No#	Size	Type
PVCPTRAP11/2	1-1/2"	H x H
PVCPTRAP2	2"	H x H
PVCPTRAP3	3"	H x H
PVCPTRAP4	4"	H x H

Union P-Trap



- . Used to trap sewer gases from entering a drain line

Part No#	Size	Type
PVCUNIONPTRAP11/2	1-1/2"	H x H
PVCUNIONPTRAP2	2"	H x H

PVC DWV FITTINGS

LA Pattern P-Trap



- . Used to trap sewer gases from entering a drain line
- . Includes trap adapter with nut and washer

Part No#	Size	Type
PVCLAPTRAP11/2	1-1/2"	H x SJT

Cast Iron No Hub Adapter



- . Adapts PVC pipe to cast iron no hub pipe
- . Must use no hub coupling to adapt to no hub

Part No#	Size	Type
PVCNOHUBADPT2	2"	H x SPG
PVCNOHUBADPT3	3"	H x SPG
PVCNOHUBADPT4	4"	H x SPG

Coupling With Stop



- . Used to join straight lengths of pipe together

Part No#	Size	Type
PVCCOUP11/2	1-1/2"	H x H
PVCCOUP2	2"	H x H
PVCCOUP3	3"	H x H
PVCCOUP4	4"	H x H
PVCCOUP6	6"	H x H
PVCCOUP8	8"	H x H
PVCCOUP10	10"	H x H

Coupling Less Stop



- . Used to slip over lengths of pipe to splice two lengths together
- . May also be called a "slip coupling" or "repair coupling"

Part No#	Size	Type
PVCREPAIRCOUP11/2	1-1/2"	H x H
PVCREPAIRCOUP2	2"	H x H
PVCREPAIRCOUP3	3"	H x H
PVCREPAIRCOUP4	4"	H x H

LOOKING TO ADAPT SCHEDULE 40 PIPE TO SEWER & DRAIN PIPE? CHECK OUT THE SEWER & DRAIN FITTINGS!

Multi Coupling



- . 3" x 2" - accepts 2" PVC DWV fitting and 3" PVC DWV piping
- . 4" x 3" - accepts 3" PVC DWV fitting and 4" PVC DWV piping

Part No#	Size	Type
WAL3X2MULTICOUP	3" x 2"	(H/SPG x H/SPG)
WAL4X3MULTICOUP	4" x 3"	(H/SPG x H/SPG)

Reducing Coupling



- . Used to reduce or increase pipe sizes

Part No#	Size	Type
PVCCOUP2X11/2	2" x 1-1/2"	H x H
PVCCOUP3X11/2	3" x 1-1/2"	H x H
PVCCOUP3X2	3" x 2"	H x H
PVCCOUP4X2	4" x 2"	H x H
PVCCOUP4X3	4" x 3"	H x H
PVCCOUP6X4	6" x 4"	H x H
PVCCOUP8X4	8" x 4"	H x H
PVCCOUP8X6	8" x 6"	H x H
PVCCOUP10X6	10" x 6"	H x H
PVCCOUP10X8	10" x 8"	H x H

Reducing Bushing



- . Used to fit into a fitting hub to reduce to a smaller pipe size

Part No#	Size	Type
PVCBUSH2X11/2	2" x 1-1/2"	SPG x H
PVCBUSH3X11/2	3" x 1-1/2"	SPG x H
PVCBUSH3X2	3" x 2"	SPG x H
PVCBUSH4X2	4" x 2"	SPG x H
PVVBUSH4X3	4" x 3"	SPG x H
PVCBUSH6X4	6" x 4"	SPG x H
PVCFLBUSH8X4	8" x 4"	SPG x H
PVCFLBUSH8X6	8" x 6"	SPG x H
PVCFLBUSH10X6	10" x 6"	SPG x H
PVCFLBUSH10X8	10" x 8"	SPG x H

PVC SCHEDULE 30 FITTINGS

90 Degree Elbow



- . Used to change direction in piping
- . May also be called a "1/4 bend"

Part No#	Size	Type
PVC30ELL3	3"	H x H

90 Degree Street Elbow



- . Used to change direction in piping
- . May also be called a "street 1/4 bend"

Part No#	Size	Type
PVC30STELL3	3"	SPG x H

45 Degree Elbow



- . Used to change direction in piping
- . May also be called a "1/8 bend"

Part No#	Size	Type
PVC30453	3"	H x H

45 Degree Street Elbow



- . Used to change direction in piping
- . May also be called a "street 1/8 bend"

Part No#	Size	Type
PVC30ST453	3"	SPG x H

22 1/2 Degree Elbow



- . Used to change direction in piping
- . May also be called a "1/16 bend"

Part No#	Size	Type
PVC30221/23	3"	H x H

60 Degree Elbow



- . Used to change direction in piping
- . May also be called a "1/6 bend"

Part No#	Size	Type
PVC30603	3"	H x H

Wye



- . Used to connect a branch line to a horizontal drain line

Part No#	Size	Type
PVC30WYE3	3"	H x H x H

Reducing Wye



- . Used to connect a branch line to a horizontal drain line

Part No#	Size	Type
PVC30WYE3X11/2	3" x 3" x 1-1/2"	H x H x H
PVC30WYE3X2	3" x 3" x 2"	H x H x H

Double Wye



- . Used to connect two branch lines to a horizontal drain line

Part No#	Size	Type
PVC30DBLWYE3	3"	H x H x H x H

Sanitary Tee



- . Used to connect a branch line to a vertical drain line

Part No#	Size	Type
PVC30SANTEE3	3"	H x H x H

Reducing Sanitary Tee



- . Used to connect a branch line to a vertical drain line

Part No#	Size	Type
PVC30SANTEE3X11/2	3" x 1-1/2"	H x H x H
PVC30SANTEE3X2	3" x 2"	H x H x H

PVC SCHEDULE 30 FITTINGS

Reducing Double Sanitary Tee



- . Used to connect two branch lines to a vertical drain line
- . May also be called a "sanitary cross"

Part No#	Size	Type
PVC30DBLSANTEEE3X11/2	3" x 3" x 1-1/2" x 1-1/2"	H x H x H x H
PVC30DBLSANTEEE3X2	3" x 3" x 2" x 2"	H x H x H x H

Cleanout Tee With Flush Plug



- . Used with a threaded plug to provide a cleanout opening

Part No#	Size	Type
PVC30C/OTEE3	3"	H x H x FPT

Female Adapter



- . Adapts schedule 30 to standard female pipe thread

Part No#	Size	Type
PVC30FIPADPT3	3"	H x FPT

Fitting Cleanout With Raised Head Plug



- . Adapts from schedule 30 hub to standard female pipe thread

Part No#	Size	Type
PVC30FTGCO3	3"	SPG x FPT

Glue Cap



- . Used to cap off schedule 30 pipe

Part No#	Size	Type
PVC30CAP3	3"	H

Schedule 30 To Schedule 40 Bushing



- . Adapts 3" schedule 30 hub to 3" schedule 40 spigot

Part No#	Size	Type
PVC30X40ADAPTER3	3"	H x SPG

Coupling With Stop



- . Used to join straight lengths of pipe together

Part No#	Size	Type
PVC30COUP3	3"	H x H

Coupling Less Stop



- . Used to slip over pipe to splice two lengths together

Part No#	Size	Type
PVC30SLIPCOUP3	3"	H x H

Reducing Coupling



- . Used to reduce or increase pipe sizes

Part No#	Size	Type
PVC30COUP3x11/2	3" x 1-1/2"	H x H
PVC30COUP3X2	3" x 2"	H x H

Reducing Bushing

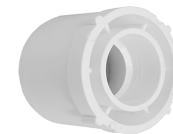

- . Used to fit into a fitting hub to reduce to smaller pipe sizes

Part No#	Size	Type
PVC30BUSH3X11/2	3" x 1-1/2"	SPG x H
PVC30BUSH3X2	3" x 2"	SPG x H
PVC30BUSH4X3	4" x 3"	SPG x H

PVC PRESSURE FITTINGS

90 Degree Elbow



- . Used to change direction in piping
- . May also be called a "1/4 bend"

Part No#	Size	Type
PVC40ELL1/2	1/2"	H x H
PVC40ELL3/4	3/4"	H x H
PVC40ELL1	1"	H x H
PVC40ELL11/2	1-1/2"	H x H
PVC40ELL2	2"	H x H

90 Degree Street Elbow



- . Used to change direction in piping
- . May also be called a "street 1/4 bend"

Part No#	Size	Type
PVC40STELL1/2	1/2"	SPG x H
PVC40STELL3/4	3/4"	SPG x H
PVC40STELL1	1"	SPG x H
PVC40STELL2	2"	SPG x H

45 Degree Elbow



- . Used to change direction in piping
- . May also be called a "1/8 bend"

Part No#	Size	Type
PVC40451/2	1/2"	H x H
PVC40453/4	3/4"	H x H
PVC40451	1"	H x H
PVC404511/2	1-1/2"	H x H
PVC40452	2"	H x H

45 Degree Street Elbow



- . Used to change direction in piping
- . May also be called a "street 1/8 bend"

Part No#	Size	Type
PVC40ST451/2	1/2"	SPG x H
PVC40ST453/4	3/4"	SPG x H

Tee



- . Used to connect a branch line to a single main line

Part No#	Size	Type
PVC40TEE1/2	1/2"	H x H x H
PVC40TEE3/4	3/4"	H x H x H
PVC40TEE1	1"	H x H x H
PVC40TEE11/2	1-1/2"	H x H x H
PVC40TEE2	2"	H x H x H

Reducing Tee



- . Used to connect a branch line to a single main line

Part No#	Size	Type
PVC40TEE1X3/4	1" x 1" x 3/4"	H x H x H
PVC40TEE2x11/2	2" x 2" x 1-1/2"	H x H x H

Male Adapter



- . Adapts PVC to standard male pipe thread

Part No#	Size	Type
PVC40MIPADPT1/2	1/2"	H x MPT
PVC40MIPADPT3/4	3/4"	H x MPT
PVC40MIPADPT1	1"	H x MPT
PVC40MIPADPT11/2	1-1/2"	H x MPT
PVC40MIPADPT2	2"	H x MPT

Female Adapter



- . Adapts PVC to standard female pipe thread

Part No#	Size	Type
PVC40FIPADPT1/2	1/2"	H x FPT
PVC40FIPADPT3/4	3/4"	H x FPT
PVC40FIPADPT1	1"	H x FPT

PVC PRESSURE FITTINGS

Glue Cap



- . CAPS IN DWV SECTION ARE ALSO RATED FOR PRESSURE
- . Used to cap off PVC pipe

Part No#	Size	Type
PVC40CAP1/2	1/2"	H
PVC40CAP3/4	3/4"	H
PVC40CAP1	1"	H

Condensate P-Trap



- . Used most commonly for air conditioner condensation drains

Part No#	Size	Type
SIOPVCPTRAP3/4	3/4"	H x H

Union



- . Used to join straight lengths of pipe together
- . Allows for future disassembly if needed

Part No#	Size	Type
LEG1/2PVCUNION40	1/2"	H x H
LEG3/4PVCUNION40	3/4"	H x H
LEG1PVCUNION40	1"	H x H
LEG11/2PVCUNION40	1-1/2"	H x H
LEG2PVCUNION40	2"	H x H

Coupling With Stop



- . Used to join straight lengths of pipe together

Part No#	Size	Type
PVC40COUP1/2	1/2"	H x H
PVC40COUP3/4	3/4"	H x H
PVC40COUP1	1"	H x H
PVC40COUP11/2	1-1/2"	H x H
PVC40COUP2	2"	H x H

Reducing Bushing



- . Used to fit into a fitting hub to reduce to smaller pipe sizes

Part No#	Size	Type
PVC40BUSH3/4X1/2	3/4" x 1/2"	SPG x SLIP
PVC40BUSH1X1/2	1" x 1/2"	SPG x SLIP
PVC40BUSH1X3/4	1" x 3/4"	SPG x SLIP
PVC40BUSH11/2X1/2	1-1/2" x 1/2"	SPG x SLIP
PVC40BUSH11/2X3/4	1-1/2" x 3/4"	SPG x SLIP
PVC40BUSH11/2X1	1-1/2" x 1"	SPG x SLIP
PVC40BUSH11/2X11/4	1-1/2" x 1-1/4"	SPG x SLIP
PVC40BUSH2X11/2	2" x 1-1/2"	SPG x SLIP

Reducing FPT Bushing



- . Used to fit into a fitting hub to reduce to smaller FPT

Part No#	Size	Type
PVC40FIPBUSH11/4X1	1-1/4" x 1"	SPG x FPT
PVC40FIPBUSH11/2X1/2	1-1/2" x 1/2"	SPG x FPT
PVC40FIPBUSH11/2X3/4	1-1/2" x 3/4"	SPG x FPT
PVC40FIPBUSH11/2X1	1-1/2" x 1"	SPG x FPT
PVC40FIPBUSH11/2X11/4	1-1/2" x 1-1/4"	SPG x FPT
PVC40FIPBUSH2X11/2	2" x 1-1/2"	SPG x FPT

CPVC FITTINGS

90 Degree Elbow



- . Used to change direction in piping
- . May also be called a "1/4 bend"

Part No#	Size	Type
CPVCELL1/2	1/2"	H x H
CPVCELL3/4	3/4"	H x H
CPVCELL1	1"	H x H

90 Degree Street Elbow



- . Used to change direction in piping
- . May also be called a "street 1/4 bend"

Part No#	Size	Type
CPVCSTELL1/2	1/2"	SPG x H
CPVCSTELL3/4	3/4"	SPG x H
CPVCSTELL1	1"	SPG x H

90 Degree Reducing Elbow



- . Used to change direction in piping
- . May also be called a "reducing 1/4 bend"

Part No#	Size	Type
CPVCELL3/4X1/2	3/4" x 1/2"	H x H

90 Degree Wing Elbow With Stainless Threads



- . 90 degree elbow adapts CPVC to standard female pipe thread
- . Reinforced stainless steel threads
- . Includes bracket for easy mounting
- . May also be called a "shower elbow"

Part No#	Size	Type
LEG1/2FIPXCPVCWINGEL	1/2"	H x FPT

45 Degree Elbow



- . Used to change direction in piping
- . May also be called a "1/8 bend"

Part No#	Size	Type
CPVC451/2	1/2"	H x H
CPVC453/4	3/4"	H x H
CPVC451	1"	H x H

45 Degree Street Elbow



- . Used to change direction in piping
- . May also be called a "street 1/8 bend"

Part No#	Size	Type
CPVCST451/2	1/2"	SPG x H
CPVCST453/4	3/4"	SPG x H

Tee



- . Used to connect a branch line to a single main line

Part No#	Size	Type
CPVCTEE1/2	1/2"	H x H x H
CPVCTEE3/4	3/4"	H x H x H
CPVCTEE1	1"	H x H x H

Reducing Tee



- . Used to connect a branch line to a single main line

Part No#	Size	Type
CPVCTEE3/4X1/2	3/4" x 3/4" x 1/2"	H x H x H
CPVCTEE3/4X1/2X1/2	3/4" x 1/2" x 1/2"	H x H x H

Male Adapter



- . Adapts CPVC to standard male pipe thread

Part No#	Size	Type
CPVCMIPADPT1/2	1/2"	H x MPT
CPVCMIPADPT3/4	3/4"	H x MPT
CPVCMIPADPT1	1"	H x MPT

CPVC Male Adapter With Stainless Threads



- . Adapts CPVC to standard male pipe thread
- . Reinforced stainless steel threads

Part No#	Size	Type
LEG1/2MIPXCPVCADAPTE	1/2"	H x MPT
LEG3/4MIPXCPVCADAPTE	3/4"	H x MPT
LEG1MIPXCPVCADAPTER	1"	H x MPT

CPVC FITTINGS

CPVC Female Adapter With Stainless Threads



- . Adapts CPVC to standard female pipe thread
- . Reinforced stainless steel threads

Part No#	Size	Type
LEG1/2FIPXCPVCADAPTE	1/2"	H x FPT
LEG3/4FIPXCPVCADAPTE	3/4"	H x FPT
LEG1FIPXCPVCADAPTER	1"	H x FPT

Glue Cap



- . Used to cap off CPVC pipe

Part No#	Size	Type
CPVCCAP1/2	1/2"	H
CPVCCAP3/4	3/4"	H
CPVCCAP1	1"	H

Coupling With Stop



- . Used to join straight lengths of pipe together

Part No#	Size	Type
CPVCCOUP1/2	1/2"	H x H
CPVCCOUP3/4	3/4"	H x H
CPVCCOUP1	1"	H x H

Reducing Coupling



- . Used to reduce or increase pipe sizes

Part No#	Size	Type
CPVCCOUP3/4X1/2	3/4" x 1/2"	H x H
CPVCCOUP1X3/4	1" x 3/4"	H x H

Reducing Bushing



- . Used to fit into a fitting hub to reduce to smaller pipe sizes

Part No#	Size	Type
CPVCBUSH3/4X1/2	3/4" x 1/2"	SPG x SLIP
CPVCBUSH1X1/2	1" x 1/2"	SPG x SLIP
CPVCBUSH1X3/4	1" x 3/4"	SPG x SLIP

CPVC Full Port Ball Valve



- . One piece CPVC body
- . Standard port handle
- . For water supply only, not to be used with compressed air

Part No#	Size	Type
LEG1/2CPVCBALLVALVE	1/2"	H x H
LEG3/4CPVCBALLVALVE	3/4"	H x H
LEG1CPVCBALLVALVE	1"	H x H

CPVC Multi Turn Supply Valve



- . Multi Turn style handle
- . Chrome plated

Part No#	Size	Type
LEG1/2X3/8CPVCANGLES	1/2" CPVC x 3/8" OD	Angle
LEG1/2X3/8CPVCSTRSTO	1/2" CPVC x 3/8" OD	Straight

CPVC Adapter For Water Heater Pan



- . Adapts CPVC to standard male pipe threads
- . Includes nut and gasket to seal hole for a water heater drain pan

Part No#	Size	Type
OATPANADAPTER	1"	H x FPT

Water Hammer Arrestor For CPVC



- . Accepts CPVC pipe or fitting directly into hammer arrestor

Part No#	Size	Type
SIOCPVCMINIRESTER1/2	1/2"	H

90 Degree Elbow



. Used to change direction in piping
 . May also be called a "1/4 bend"

Part No#	Size	Type
PVCS&DELL4	4"	H x H
PVCS&DELL6	6"	H x H

90 Degree Street Elbow



. Used to change direction in piping
 . May also be called a "street 1/4 bend"

Part No#	Size	Type
PVCS&DSTELL4	4"	SPG x H

45 Degree Elbow



. Used to change direction in piping
 . May also be called a "1/8 bend"

Part No#	Size	Type
PVCS&D454	4"	H x H
PVCS&D456	6"	H x H

45 Degree Street Elbow



. Used to change direction in piping
 . May also be called a "street 1/8 bend"

Part No#	Size	Type
PVCS&DST454	4"	SPG x H
PVCS&DST456	6"	SPG x H

22 1/2 Degree Elbow



. Used to change direction in piping
 . May also be called a "1/16 bend"

Part No#	Size	Type
PVCS&D221/24	4"	H x H
PVCS&D221/26	6"	H x H

Wye



. Used to connect a branch line to a horizontal drain line

Part No#	Size	Type
PVCS&DWYE4	4"	H x H x H

Tee



. Used to connect a branch line to a vertical drain line

Part No#	Size	Type
PVCS&DTEE4	4"	H x H x H

Double Tee



. Cross tee accepts sewer and drain pipe on all four sides

Part No#	Size	Type
PVCS&DCROSS4	4"	H x H x H x H

Female Adapter Less Plug



. Adapts from sewer and drain pipe to standard female pipe threads

Part No#	Size	Type
PVCS&DFIPADAPT4	4"	H x FPT

Fitting Cleanout Less Plug



. Adapts from sewer and drain hub to standard female pipe threads

Part No#	Size	Type
PVCS&DFTGCO4	4"	SPG x FPT

Cap



. Used to cap off sewer and drain pipe

Part No#	Size	Type
PVCS&DCAP4	4"	H
PVCS&DCAP6	6"	H

Coupling With Stop



. Used to join lengths of sewer and drain pipe together

Part No#	Size	Type
PVCS&DCOUP4	4"	H x H
PVCS&DCOUP6	6"	H x H

Sewer & Drain To PVC Coupling



. Adapts sewer and drain pipe to PVC DWV pipe

Part No#	Size	Type
PVCS&DCOUP4X3	4" x 3"	H (S & D) x H (PVC)
PVCS&DXPVCCOUP6	6"	H (S & D) x H (PVC)

Sewer & Drain To PVC Bushing



. Adapts sewer and drain fitting to PVC DWV pipe

Part No#	Size	Type
PVCS&D30BUSH4X3	4" x 3" (Schedule 30)	FTG x H
PVCS&DXPVCBUSH4	4"	FTG x H
PVCS&DXPVCBUSH6	6"	FTG x H

Sock Material



. Forms a water barrier to seal against deposit build up

. Tear resistant sock slips over pipe easily

Part No#	Size	Type
HAVSOCK4x100	4" x 100'	Sock Material

**Madison Heights
Plumbing & Heating Supply**

SECTION 6 -

SUMP PUMPS & BUCKETS

Sump Pumps 151-152
Sump Pump Buckets 153

SUMP PUMPS & BACKUPS

Zoeller Cast Iron Sump Pumps



- . Corrosion resistant cast iron body
- . Float operated, submersible switch
- . 3 year warranty
- . 1-1/2" MPT discharge

Part No#	Zoeller Part#	Horsepower
ZOEM53	53-0001	1/3



- . Corrosion resistant cast iron body
- . Float operated, submersible switch
- . 5 year warranty
- . 1-1/2" MPT discharge

Part No#	Zoeller Part#	Horsepower
ZOEM63	63-0001	1/3

Myers Cast Iron Sump Pump



- . Cast Iron body
- . Piggyback float style switch
- . Pumps from the bottom of the pump
- . 1-1/2" MPT discharge

Part No#	Myers Part#	Horsepower
MYERMDC33V1	MDC33V1	1/3

Liberty Aluminum Sump Pump



- . Aluminum body
- . High temperature thermoplastic body
- . Pumps from the bottom of the pump
- . 1-1/2" MPT discharge

Part No#	Liberty Part#	Horsepower
LIBERTY237	237	1/3

NOTE: RECEIVE BULK PRICING IF YOU PURCHASE THREE OF THE 1/3 HP SUMP PUMPS LISTED ABOVE!

Zoeller Elevator Lift Pumps



- . Includes 20' cord with float switch
- . Includes discharge PVC adapter
- . Also known as a high head pump

Part No#	Zoeller Part#	Horsepower
ZOEBN153	BN153	1/2



- . Includes 6' cord
- . Switch Kit sold separately
- . Also known as a high head pump

Part No#	Zoeller Part#	Horsepower
ZOEN153	N153	1/2
ZOEN153SWITCH	Switch Kit For N153	-

Zoeller Sewage Ejector Pump



- . Float operated, mechanical switch
- . Durable cast iron construction
- . Will pass up to a 2" solid
- . 2" MPT discharge

Part No#	Zoeller Part#	Horsepower
ZOEM267	267-0001	1/2

Zoeller Battery Back Up Complete Kit



- . Complete kit includes Zoeller M53 sump pump and battery back up pump
- . Battery not included

Part No#	Zoeller Part#	Horsepower
ZOEBATTBUKIT	508-0006	1/3

Zoeller Battery Back Up Pump Only



- . Battery back up pump only
- . Primary pump sold separately
- . Battery not included

Part No#	Zoeller Part#	Horsepower
ZOEBATTBUPUMPONLY	508-0005	-

Guardian Water Powered Back Up Pump



- . Brass components
- . Includes built in check valves
- . Mechanical float switch

Part No#	Guardian Part#	Horsepower
GUARDIANPUMP	747H20	1/2
GUARDIANSWITCH	747H20SV2	New Switch Kit
GUARDIAN FLOAT SWITC	747H20FL2	New Float Package



- . Brass components
- . Includes built in check valves
- . Mechanical float switch
- . Designed specifically for use with radon

Part No#	Guardian Part#	Horsepower
GUARDIANRADONPUMP	747H20RR	1/2

Liberty Water Powered Back Up Pump



- . Requires no electricity to work, complete water power
- . 3/4" water supply with an 1-1/2" discharge
- . Thermoplastic body
- . Vertical float style switch

Part No#	Liberty Part#	Type
LIBERTYPUMP	SJ10	Backup Pump

SUMP PUMPS & BACKUPS

Zoeller Battery Back Up Complete Kit



- . Complete kit includes Zoeller M53 sump pump and battery back up pump
- . Battery not included

Part No#	Zoeller Part#	Horsepower
ZOEBATTBUKIT	508-0006	1/3

Zoeller Battery Back Up Pump Only



- . Battery back up pump only
- . Primary pump sold separately
- . Battery not included

Part No#	Zoeller Part#	Horsepower
ZOEBATTBUPUMONLY	508-0005	-

Zoeller Laundry Tray Pump With Bucket



- . Bucket installed underneath laundry tub
- . Includes Zoeller M53 sump pump and check valve

Part No#	Zoeller Part#	Horsepower
ZOE105C	105-0001	1/3

Zoeller Condensate Pump



- . 20 GPH maximum
- . 20ft maximum head

Part No#	Zoeller Part#	Power
ZOECONDENSATEPUMP	519-0005	115v

Gorilla Clear Condensate Tubing



- . Clear condensate tubing
- . Sold in coil quantity only

Part No#	Size	Color
GOR3/8x100TUBE	3/8" OD x 100'	Clear

Zoeller Pump Alarm Systems



- . Alarm systems for sump pumps

Part No#	Description	Type
ZOEBATTALARMPANEL	Standard Alarm Panel	Pump Alarm
ZOEWIFIALARMPANEL	Wi-Fi Alarm Panel	Pump Alarm

Zoeller Float Switch



- . Converts non-automatic pumps to automatic

Part No#	Zoeller Part#	Type
ZOEMERCSWITCH	10-0034	Float Switch

Sump Pump Discharge Hose



- . Includes barb to MPT fitting and hose clamps

Part No#	Size	Type
WALSUMPPUMPDISCHOS	1-1/2" x 24'	Corrugated

Plastic Sump Bucket With Lid



- . Corrugated plastic sump pump basin
- . 18" diameter
- . Lid is included

Part No#	Size	Type
SUM24BUCKET/LID	18" x 24"	Plastic
SUM30BUCKET/LID	18" x 30"	Plastic
SUMLID	18" Lid Only	Plastic

LOOKING FOR EXTRA GASKETS FOR EJECTOR BUCKETS? GIVE US A CALL! WE MAY HAVE EXTRA PARTS!

Plastic Ejector Buckets & Lids



- . 30" bucket includes pre-drilled hole on side of bucket
- . Lid sold separately and includes all gaskets needed

Part No#	Size	Type
SUM30EJECTOR	18" x 30"	Plastic
SUMLIDEJECTOR	18" Lid Only	Plastic



- . 22" bucket includes no holes on bucket
- . Lid sold separately and includes all gaskets needed

Part No#	Size	Type
SUM22BUCKET	18" x 22"	Plastic
SUM18SOLIDLID	18" Lid Only	Plastic



- . 30" bucket with typically used for an elevator pit
- . Steel lid sold separately includes all gaskets needed

Part No#	Size	Type
SUM30UNDRILLED BASIN	18" x 30"	Plastic
SUM18STEELLID	18" Lid Only	Steel

Madison Heights Plumbing & Heating Supply

SECTION 7 -

WATER HEATERS

Water Heaters	155-161
Water Heater Accessories	162-164
Recirculation Pumps	165-166
Fume Pipe & Fittings	166-169



Lochinvar Tankless Water Heater



- . 3/4" gas connection
- . 5 year warranty on all parts
- . Valve kit sold separately
- . For indoor use only
- . Factory installed power cord

Part No#	Lochinvar Part#	Description	BTU Rating	PVC Vent Size
LOCLTI540H-N	LTI-540H-N	Tankless Water Heater	199,000	3"
LOCLTI540P-N	LTI-540P-N	Tankless Water Heater With Built In Recirculation Pump	199,000	3"

Tankless Water Heater Valve Kit



- . To be used with tankless water heaters
- . Includes two valves and t & p relief valve

Part No#	Size	Type
BRATANKLESSVALVEKIT	3/4"	FPT

PVC Concentric Termination Kit



- . For use on a sidewall termination on tankless water heaters

Part No#	Size	Type
LOC100112163	3" & 4"	PVC

Standard Vent Gas



- Energy saver residential water heaters
- Glass lined steel tank
- Includes protective anode rod
- Electronic gas control valve with diagnostic lights
- Fume pipe venting
- Meets Federal Energy Conservation Standards
- Includes T & P relief valve
- Warranty Includes:
 - . 6 Years on water heater tank
 - . 6 Years on water heater parts
 - . 1 Year on factory maintenance

Lochinvar Standard Gas Water Heaters

Part No#	Lochinvar Part#	Description	BTU Rating	Fume Vent Size
LOCGTN03032R	GTN03032R	30 Gallon Tall Residential With Blanket	32,000	3"
LOCGSN04040	GSN04040	40 Gallon Short Residential	40,000	4"
LOCGTN04040	GTN04040	40 Gallon Tall Residential	40,000	4"
LOCGTN04040B	GTN04040B	40 Gallon Tall Residential With Blanket	40,000	4"
LOCGSN05040	GSN05040	50 Gallon Short Residential	40,000	4"
LOCGTN05040	GTN05040	50 Gallon Tall Residential	40,000	4"
LOCGTN05050	GTN05050	50 Gallon Tall High Recovery Residential	50,000	4"
LOCGTN05060B	GTN05060B	50 Gallon Tall High Recovery Residential With Blanket	60,000	4"
LOCLTN07575	LTN07575	75 Gallon Tall Residential	75,000	4"

Power-Vent Gas



- Energy saver residential water heaters
- Glass lined steel tank
- Includes protective anode rod
- Electronic gas control valve with diagnostic lights
- PVC pipe venting
- Meets Federal Energy Conservation Standards
- Includes T & P relief valve
- Warranty Includes:
 - . 6 Years on water heater tank
 - . 6 Years on water heater parts
 - . 1 Year on factory maintenance

Lochinvar Power-Vent Gas Water Heaters

Part No#	Lochinvar Part#	Description	BTU Rating	PVC Vent Size
LOCPVN04040	PVN04040	40 Gallon Power-Vent Residential	40,000	2", 3", 4"
LOCPVN05040	PVN05040	50 Gallon Power-Vent Residential	40,000	2", 3", 4"
LOCPVN05050	PVN05050	50 Gallon High Recovery Power-Vent Residential	50,000	2", 3", 4"
LOCPVN07575ST	PVN075757ST	75 Gallon Power-Vent Residential	75,000	3", 4"

Residential Electric



- Energy saver residential water heaters
- Glass lined steel tank
- Includes standard and junior versions
- Meets Federal Energy Conservation Standards
- Includes T & P relief valve
- Warranty Includes:
 - . 6 Years on water heater tank
 - . 6 Years on water heater parts
 - . 1 Year on factory maintenance

Lochinvar Residential Electric Water Heaters

Part No#	Lochinvar Part#	Description	Volts	Water Connection
LOCJEC002BS	JEC002BS	2.5 Gallon Junior Electric Water Heater	120v	1/2"
LOCJRC006DS	JRC006DS	6 Gallon Junior Electric Water Heater	120v	3/4"
LOCJRC010DS	JRC010DS	10 Gallon Electric Water Heater	120v	3/4"
LOCJRC020DS	JRC020DS	20 Gallon Electric Water Heater	120v	3/4"
LOCKSA030KDB	KSA030KD	30 Gallon Short Electric Water Heater With Blanket	240v	3/4"
LOCKTA030KD	KTA030KD	30 Gallon Tall Electric Water Heater	240v	3/4"
LOCKSA040KDB	KSA036KDB	40 Gallon Short Electric Water Heater With Blanket	240v	3/4"
LOCKMA040KD	KMA040KD	40 Gallon Tall Electric Water Heater	240v	3/4"
LOCKMA050KD	KMA050KD	50 Gallon Tall Electric Water Heater	240v	3/4"
LOCETA082KD	ETA082KD	80 Gallon Electric Water Heater	240v	3/4"



Commercial Standard Gas



- Commercial Gas water Heater
- Glass lined steel tank
- Electronic gas control valve with diagnostic lights
- Fume pipe venting
- Meets Federal Energy Conservation Standards
- Includes T & P relief valve
- Warranty Includes:
 - . 6 Years on water heater tank
 - . 6 Years on water heater parts
 - . 1 Year on factory maintenance

Lochinvar Commercial Gas Water Heaters

Part No#	Lochinvar Part#	Description	BTU Rating	Fume Vent Size
LOCCGN200080	CGN200080	80 Gallon Commercial Gas Water Heater	199,000	6"
LOCCGN200100	CGN200100	100 Gallon Commercial Gas Water Heater	199,000	6"

Commercial Power-Vent Gas



- Energy saver residential water heaters
- Glass lined steel tank
- Electronic gas control valve with diagnostic lights
- PVC pipe venting
- Meets Federal Energy Conservation Standards
- Includes T & P relief valve
- Warranty Includes:
 - . 6 Years on water heater tank
 - . 6 Years on water heater parts
 - . 1 Year on factory maintenance

Lochinvar Commercial Power Vented Gas Water Heaters

Part No#	Lochinvar Part#	Description	BTU Rating	PVC Vent Size
LOCSNR200100	SNR200100	100 Gallon Commercial Power-Vent Water Heater	199,000	3"

Storage Tanks



- Glass lined steel tank
- Energy saving performance
- T & P relief valve **NOT** included
- Warranty Includes:
 . 5 year limited warranty

Lochinvar Storage Tanks

Part No#	Lochinvar Part#	Description	Drain Size	T & P Connection
LOCRJS080M	RJS080M	80 Gallon Storage Tank	3/4"	1"
LOCRJS120M	RJS120M	100 Gallon Storage Tank	3/4"	1"

Female Dielectric Union



- . Must be used when connecting copper to galvanized pipe to avoid electrolysis of dissimilar metals
- . Zinc plated steel
- . Includes rubber gasket
- . Lead free

Part No#	Size	Type
LEG1/2DIELECTRICUNION	1/2"	C x FPT
LEG3/4DIELECTRICUNION	3/4"	C x FPT
LEG1DIELECTRICUNION	1"	C x FPT
LEG11/4DIELECTRICUNIO	1-1/4"	C x FPT
LEG11/2DIELECTRICUNIO	1-1/2"	C x FPT
LEG2DIELECTRICUNION	2"	C x FPT
LEG21/2DIELECTRICUNIO	2-1/2"	C x FPT
LEG3DIELECTRICUNION	3"	C x FPT

Male Dielectric Union



- . Must be used when connecting copper to galvanized pipe to avoid electrolysis of dissimilar metals
- . Zinc plated steel
- . Includes rubber gasket
- . Lead free

Part No#	Size	Type
LEG1/2MIPDIELECTRICUNI	1/2"	C x MPT
LEG3/4MIPDIELECTRICUNI	3/4"	C x MPT

Rubber Gasket For Dielectric Union



- . Replacement rubber gasket for dielectric union
- . For use with water only

Part No#	Size	Type
LEG1/2DIELECTRICGASKET	1/2"	Rubber
LEG3/4DIELECTRICGASKET	3/4"	Rubber
LEG1DIELECTRICGASKET	1"	Rubber
LEG11/4DIELECTRICGAS	1-1/4"	Rubber
LEG11/2DIELECTRICGASKE	1-1/2"	Rubber
LEG2DIELECTRICGASKET	2"	Rubber

Copper Press Female Dielectric Union



- . Must be used when connecting copper to galvanized pipe to avoid electrolysis of dissimilar metals
- . Zinc plated steel
- . Uses copper press connection
- . Lead free

Part No#	Size	Type
LEG1/2PRESSDIELECTRI	1/2"	Press x FPT
LEG3/4PRESSDIELECTRI	3/4"	Press x FPT
LEG1PRESSDIELECTRIC	1"	Press x FPT
LEG11/4PRESSDIELECTR	1-1/4"	Press x FPT
LEG11/2PRESSDIELECTR	1-1/2"	Press x FPT
LEG2PRESSDIELECTRIC	2"	Press x FPT

Universal Copper Thermocouple



- . Universal kit to fit most water heater brands

Part No#	Length	Type
KNOX18THERMOCOUPLE	18"	Copper
KNOX24THERMOCOUPLE	24"	Copper
KNOX30THERMOCOUPLE	30"	Copper
KNOX36THERMOCOUPLE	36"	Copper
KNOX48THERMOCOUPLE	48"	Copper

Water Heater Elements



- . Universal replacement water heater elements
- . 1" plug size

Part No#	Watts	Volts
KNOXS115ELEMENT	1500	120
KNOXS245ELEMENT	4500	240

Water Heater Element Wrench



- . Zinc plated steel
- . Used to remove water heater elements

Part No#	Size	Type
KNOXELEMENTWRENCH	1-1/2 ID - 1-3/4 OD	Steel

Electric Water Heater Replacement Thermostats



- . Replacement thermostats for electric water heaters

Part No#	Type	Type
KNOXSINGLESTAT	Single	Plastic/Metal
KNOXUPPERSTAT	Upper	Plastic/Metal
KNOXLLOWERSTAT	Lower	Plastic/Metal

Water Heater T & P Overflow Tube



- . 3/4 plastic standard male pipe threads
- . Easy to cut to needed size

Part No#	Size	Type
WAT100DT	3/4"	MPT

Round Aluminum Water Heater Pan



- . Can be installed under any gas or electric water heater
- . Protects floor from water heater leaks
- . Includes 1" CPVC adapter with nut and gasket

Part No#	Size	Type
OATHEATERPAN18	18"	Aluminum
OATHEATERPAN20	20"	Aluminum
OATHEATERPAN22	22"	Aluminum
OATHEATERPAN24	24"	Aluminum
OATHEATERPAN26	26"	Aluminum
OATHEATERPAN30	30"	Aluminum

CPVC Adapter For Water Heater Pan



- . Adapts CPVC to standard male pipe threads
- . Includes nut and gasket to seal hole for a water heater drain pan

Part No#	Size	Type
OATPANADAPTER	1"	H x MPT

Square Aluminum Water Heater Pans



- . Blank square water heater pan
- . Drain fitting not included

Part No#	Size	Type
SHE36SQUAREPAN	36" x 36"	Floor



- . Wall mount heater pan
- . Will hold up to a 20 gallon water heater or 375 lbs
- . Includes 1" PVC drain fitting

Part No#	Size	Type
HOL40-SWHP-W	21-1/4" x 21-1/4" x 2-1/2"	Wall Mount



- . Ceiling mount heater pan
- . Will hold up to a 20 gallon water heater or 375 lbs
- . Includes 1" PVC drain fitting

Part No#	Size	Type
HOL40-SWHP	21-1/4" x 21-1/4" x 2-1/2"	Ceiling Mount



- . Ceiling mount heater pan
- . Will hold up to a 50 gallon water heater or 600 lbs
- . Includes 1" CPVC drain fitting

Part No#	Size	Type
HOL50-SWHP-C	26-1/2" x 26-1/2" x 2-1/2"	Ceiling Mount

Water Heater Expansion Tank



- . Used for potable water systems to absorb increased volume of water by thermal expansion

Part No#	Tank Size	Connection
WATPLT5EXPTANK	2.1 Gallon	3/4" MPT
WATPLT12EXPTANK	4.5 Gallon	3/4" MPT
WATPLT20EXTTANK	8.5 Gallon	3/4" MPT

Boiler Heating Expansion Tank



- . To be used on non potable water systems to absorb increased volume of water by thermal expansion
- . Common use for boilers

Part No#	Tank Size	Connection
WAT15HEATINGTANK	2.1 Gallon	1/2" MPT
WAT30HEATINGTANK	4.5 Gallon	1/2" MPT
WAT60HEATINGTANK	6.0 Gallon	1/2" MPT

Vacuum Relief For Electric Water Heater



- . Designed for use on water heater lines to protect against internal vacuum conditions that could damage a system
- . Could also be used on storage tanks
- . Brass body

Part No#	Size	Type
WILVR10XL	3/4"	MPT

Dip Tubes



- . Fits most Lochinvar residential tanks

Part No#	Lochinvar Part#	Connection
LOC100327005	100327005	3/4" MPT

Honeywell Strap On Aquastat



- . Regulates temperatures in boilers, storage tanks and more
- . Temperature range: 65° F to 200° F.

Part No#	Honeywell Part#	Type
HON6006C1018	L6006C1018	Aquastat

T & P Valves With Probe



- . Provides automatic temperature and pressure relief for water heaters and storage tanks
- . Lead Free

Part No#	Description	Connection
WAT100XL3/4	Standard T & P Valve	3/4" MPT
WATL100XL3/4	Long T & P Valve	3/4" MPT
LOCRLV2008	125 PSI T & P Valve	3/4" FPT
LOCRLV1014	125 PSI T & P Valve	3/4" FPT
LOCRLV1015	150 PSI T & P Valve	1" FPT

T & P Valve Without Probe



- . Pressure set point: 30 PSI
- . Most commonly used for a boiler system

Part No#	Description	Connection
WATRELIEF30#	T & P Valve Less Probe	3/4" FPT

Watts Pressure Relief Valve



- . Discharges water if excess pressure should develop in a system
- . Capacity: 650,000 BTU
- . Pressure set point: 30 PSI

Part No#	Watts Part#	Connection
WATRELIEF174A3/4	0274428	3/4" FPT

Bell & Gossett Pressure Reducing Valve



- . Lead free
- . Contains fast filling feature (1/2" only)
- . Fills a system to a preset pressure

Part No#	B & G Part#	Size
B&GFB38	FB-38LF 110192LF	1/2" FPT
B&GB712	B7-12LF 110196LF	3/4" FPT

Cast Iron Air Purger



- . Designed to separate trapped air from the water with a closed-loop hydronic heating system
- . Heavy cast iron construction

Part No#	Size	Type
WATAIRSCOOP1	1" FPT	Cast Iron
WATAIRSCOOP11/4	1-1/4" FPT	Cast Iron

Water Main Vent



- . Designed to vent trapped air in a system
- . #7 - maximum temperature of 240°F at 75 psi
- . # - maximum temperature of 240°F at 150 psi

Part No#	B & G Part#	Size
B&G7	113001	1/8" FPT
B&G97	113222	1/8" MPT

Boiler Heating Expansion Tank



- . To be used on non potable water systems to absorb increased volume of water by thermal expansion
- . Common use for boilers

Part No#	Tank Size	Connection
WAT15HEATINGTANK	2.1 Gallon	1/2" MPT
WAT30HEATINGTANK	4.5 Gallon	1/2" MPT
WAT60HEATINGTANK	6.0 Gallon	1/2" MPT

Steam Air Vent



- . Typically installed at the top of a steam radiator for the purpose of venting trapped air from the system
- . Chrome plated finish
- . Not suitable for hot water heating systems air removal

Part No#	Size	Type
LEG3/4X1/2STEAMVENT	3/4" x 1/2"	MPT x FPT

Coin Vent



- . 1/8 standard male pipe threads
- . 125 PSI

Part No#	Description	Size
JONCOINVENT1/8	Coin Vent Only	1/8" MPT
SCHCOINVENTKEY	Coin Vent Key	Fits 1/8" Vent

Circuit Setter



- . Sweat connection
- . Assures maximum flow at minimum horsepower

Part No#	B & G Part#	Size
B&G3/4#117413LF	117413LF	3/4"
B&G1#117401LF	117401LF	1"

RECIRCULATION PUMPS/BOOSTER PUMPS

Taco Recirculation Pump



- . 1/2" sweat connection
- . Cast iron construction
- . Includes plug

Part No#	Taco Part#	Horsepower
TACO006BC4PNP	006-BC4-PNP (Timer)	1/40
TACO006B4PNP	006-B4-PNP	1/40

Taco Recirculation Pump



- . Compact design
- . High efficiency motor
- . Includes plug

Part No#	Taco Part#	Description
TACOO06E#-LC	006E3-LC	Pump With Cord

Taco Hot Link Recirculation Pump With Timer



- . Special valve fitting allows instant hot water to farthest fixture in the home
- . Includes timer, cord and hot link valve
- . 1/2" MPT connection

Part No#	Taco Part#	Description
TACOHLPE-1	HLPE-1	Pump Kit
TACOHLV1	HLV1	Hot Link Valve Only

Taco Recirculation Pump Adapters



- . Adapters for Taco recirculation pumps

Part No#	Taco Part#	Connection
TACOUFS-050P	TACOUFS-050P	1/2" Press
TACOUFS-050S	TACOUFS-050S	1/2" Sweat
TACOUFS-050T	TACOUFS-050T	1/2" Union FPT
TACOUFS-075P	TACOUFS-075P	3/4" Press
TACOUFS-075S	TACOUFS-075S	3/4" Sweat
TACOUFS-075T	TACOUFS-075T	3/4" Union FPT

Bell & Gossett Sweat Bronze Recirculation Pump



- . Bronze pump to be used for potable water systems only
- . 115 volt
- . Lead free

Part No#	B & G Part#	Horsepower
B&GNBF8S	103257LF	1/40

Bell & Gossett Flanged Bronze Recirculation Pump



- . Bronze pump to be used for potable water systems only
- . 115 volt
- . Lead free
- . Flanges sold separately

Part No#	B & G Part#	Horsepower
B&GNBF12	103260LF	1/40
B&GNBF22BR	103252LF	1/25
B&GLR15B	106514LF	1/12

Bell & Gossett Flanged Bronze Booster Pump



- . Bronze pump to be used for potable water systems only
- . 115 volt
- . Lead free
- . Flanges sold separately

Part No#	B & G Part#	Horsepower
B&GPL30B	1BL013LF	1/12
B&GPL36B	1BL003LF	1/6

Bell & Gossett Bronze Booster Pump



- . Bronze pump to be used for potable water systems only
- . 115 volt
- . Lead free
- . Flanges sold separately

Part No#	B & G Part#	Horsepower
B&G100BNFI	106197LF	1/12

Bronze Flanges for Recirculation Pump



- . Bronze flanges for recirculation and booster pumps
- . Specify size upon ordering

Part No#	B & G Part#	Size
B&GBRASSFLG3/4	101208	3/4"
B&GBRASSFLG1	101209	1"
B&GBRASSFLG11/4	101210	1-1/4"
B&GBRASSFLG11/2	101211	1-1/2"

BOOSTER PUMPS

Bell & Gossett Flanged Iron Recirculation Pump



- . Iron pump not suitable for potable water
- . 115 volt
- . Flanges not included

Part No#	B & G Part#	Horsepower
B&GNRF22	103251	1/25

Bell & Gossett Iron Booster Pump



- . Iron pump not suitable for potable water
- . 115 volt
- . Flanges not included

Part No#	B & G Part#	Horsepower
B&G100NFI	106189	1/12

Iron Flanges For Recirculation Pump



- . Iron flanges for recirculation and booster pumps
- . Specify size upon ordering

Part No#	B & G Part#	Size
B&GIRONFLG3/4	101201	3/4"
B&GIRONFLG1	101202	1"
B&GIRONFLG11/4	101203	1-1/4"
B&GIRONFLG11/2	101204	1-1/2"

Bell & Gossett Recirculation Pump Timer Kit



- . Increases overall efficiency of the pump
- . Can be installed on any B & G pump

Part No#	B & G Part#	Description
B>C1	TC-1 113210	Timer Kit

90 Degree Elbow



. Adjustable fume elbow
. 26 gauge

Part No#	Size	Gauge
SHEFE3	3"	26
SHEFE4	4"	26
SHEFE5	5"	26
SHEFE6	6"	26
SHEFE7	7"	26
SHEFE8	8"	26

Wye



. 26 gauge

Part No#	Size	Gauge
SHEFY4	4"	26
SHEFY5	5"	26
SHEFY	6"	26
SHEFY5X4X4	5" x 4" x 4"	26
SHEFY6X4X4	6" x 4" x 4"	26

Tee



. 26 gauge

Part No#	Size	Gauge
SHEFT3	3"	26
SHEFT4	4"	26
SHEFT5	5"	26
SHEFT6	6"	26
SHEFT7	7"	26
SHEFT8	8"	26
SHEFT4X3	4" x 4" x 3"	26
SHEFT5X3	5" x 5" x 3"	26
SHEFT5X4	5" x 5" x 4"	26
SHEFT6X3	6" x 6" x 3"	26
SHEFT6X4	6" x 6" x 4"	26
SHEFT6X5	6" x 6" x 5"	26
SHEFT8X6	8" x 8" x 6"	26

Cap

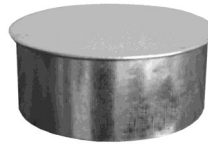

. Used to cap off fume pipe
. 26 gauge

Part No#	Size	Gauge
SHEFC3	3"	26
SHEFC4	4"	26
SHEFC5	5"	26
SHEFC6	6"	26
SHEFC7	7"	26
SHEFC8	8"	26

Reducer



. Used to increase fume pipe sizes
. 26 gauge

Part No#	Size	Gauge
SHEFR4X3	4" x 3"	26
SHEFR5X3	5" x 3"	26
SHEFR5X4	5" x 4"	26
SHEFR6X3	6" x 3"	26
SHEFR6X4	6" x 4"	26
SHEFR6X5	6" x 5"	26
SHEFR7X4	7" x 4"	26
SHEFR7X5	7" x 5"	26
SHEFR7X6	7" x 6"	26
SHEFR8X4	8" x 4"	26
SHEFR8X5	8" x 5"	26
SHEFR8X6	8" x 6"	26
SHEFR8X7	8" x 7"	26

Chimney Liner Kits



. Complete kit includes flexible vent pipe, vent hood, flashing, & pulling device

Part No#	Size	Gauge
SHECLK4X25	4" x 25'	26
SHECLK4X35	4" x 35'	26
SHECLK5X25	5" x 25'	26
SHECLK5X35	5" x 35'	26

Fume Pipe



. 26 gauge

Part No#	Size	Gauge
SHEFP3X30	3" x 30"	26
SHEFP4X30	4" x 30"	26
SHEFP5X30	5" x 30"	26
SHEFP6X30	6" x 30"	26
SHEFP7X30	7" x 30"	26
SHEFP8X30	8" x 30"	26

Fume Pipe For Dryer Vent



. 28 Gauge

. Suitable for dryer vents only

Part No#	Size	Gauge
SHEFP4X10	4 x 10'	28

Drive Cleats

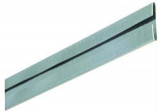

. Type "C" drive cleat

Part No#	Description	Gauge
SHECLEATS	Sheet Metal Cleat	26

Sheet Metal Crimping Tool



. Crimp tool ideal for sheet metal and ductwork

Part No#	Description	Type
SHECRIMPTOOL	Sheet Metal Crimp Tool	Steel

Sheet Metal Tin Snips



. Long lasting durability

. Comfort grips

Part No#	Type	Type
LENSTRTINSNIPS	Center	Steel
LENLHTINSNIPS	Left Hand	Steel
LENRHTINSNIPS	Right Hand	Steel

90 Degree B-Vent Elbow



. Adjustable B-Vent elbow

Part No#	Size	Type
SHEBVELL3	3"	B-Vent
SHEBVELL4	4"	B-Vent
SHEBVELL5	5"	B-Vent
SHEBVELL6	6"	B-Vent

B-Vent Strom Collar



. Provides seal above roof flashing

Part No#	Size	Gauge
SHEBVSC3	3"	26
SHEBVSC4	4"	26
SHEBVSC5	5"	26
SHEBVSC6	6"	26
SHEBVSC8	8"	26

B-Vent Round Top



. Vent top for B-Vent pipe

Part No#	Size	Gauge
SHEBVTOP3	3"	26
SHEBVTOP4	4"	26
SHEBVTOP5	5"	26
SHEBVTOP6	6"	26
SHEBVTOP8	8"	26

Tall Cone Style Roof Flashing



. Ideal for flat roofs

Part No#	Size	Gauge
SHEBVFF3	3"	26
SHEBVFF4	4"	26
SHEBVFF5	5"	26
SHEBVFF6	6"	26
SHEBVFF8	8"	26

SHEET METAL PIPE & FITTINGS/DRYER VENTING

Pitched Roof Flashing

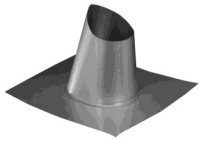

. Ideal for pitched roofs

Part No#	Size	Gauge
SHEBVPF3	3"	26
SHEBVPF4	4"	26
SHEBVPF5	5"	26
SHEBVPF6	6"	26
SHEBVPF8	8"	26

B-Vent Pipe



Part No#	Size	Type
SHEBVP3X1	3" x 1'	B-Vent
SHEBVP3X3	3" x 3'	B-Vent
SHEBVP3X5	3" x 5'	B-Vent
SHEBVP4X1	4" x 1'	B-Vent
SHEBVP4X3	4" x 3'	B-Vent
SHEBVP4X5	4" x 5'	B-Vent
SHEBVP5X1	5" x 1'	B-Vent
SHEBVP5X3	5" x 3'	B-Vent
SHEBVP5X5	5" x 5'	B-Vent
SHEBVP6X1	6" x 1'	B-Vent
SHEBVP6X3	6" x 3'	B-Vent
SHEBVP6X5	6" x 5'	B-Vent
SHEBVP8X3	8" x 3'	B-Vent
SHEBVP8X5	8" x 5'	B-Vent

Dryer Vent Hood Only



. Aluminum vent hood

Part No#	Description	Size
EMCVENTHOOD4	Dryer Vent Hood	4"

Dryer Vent Flexible Pipe



. Flexible dryer vent pipe only

Part No#	Description	Size
EMCDRYERVENT4x8	Flexible Vent Pipe	4" x 8'

Dryer Vent Complete Kit



. Aluminum complete venting kit
. Includes vent hood and flexible dryer vent pipe

Part No#	Description	Size
WALDRYERVENTKIT	Complete Dryer Vent Kit	4" x 8'

Hose Clamp For Dryer Vent Pipe



. Replacement hose clamps for dryer vent pipe

Part No#	Size	Type
EMCDUCTCLAMP	4"	Stainless Steel

Madison Heights Plumbing & Heating Supply

SECTION 8 -

PLUMBING SUPPLIES

Water Testing & Caps	171-172
Pressure Gauges	173
Venting	174-175
Water Coolers & Parts	176-177
ADA Bathroom	178
Wall Escutcheons	179
Pipe Insulation & Heat Wire	180-181
Baseboard Heating	182
Companion Flanges & Gaskets	183

TEST CAPS & PLUGS

Rubber Test Cap



- . Stainless steel hose clamp with 5/16 hex nut screw
- . Fits cast iron and plastic pipe

Part No#	Size	Type
MIS11/2CAP	1-1/2"	H
MIS2CAP	2"	H
MIS3CAP	3"	H
MIS4CAP	4"	H
MIS6CAP	6"	H
MIS8CAP	8"	H

PVC Grip Tip Test Cap



- . Thin plastic glue cap for DWV plastic pipe

Part No#	Size	Type
SIOTESTCAP11/2	1-1/2"	H
SIOTESTCAP2	2"	H
SIOTESTCAP3	3"	H
SIOTESTCAP4	4"	H

Metal Wing Nut Test Plug



- . Galvanized steel flange and wing nut
- . Fits inside cast iron and plastic pipe
- . Neoprene rubber design

Part No#	Size	Type
EVE11/2ECONOPLUG	1-1/2"	SPG
EVE2ECONOPLUG	2"	SPG
EVE3ECONOPLUG	3"	SPG
EVE4ECONOPLUG	4"	SPG
EVE6ECONOPLUG	6"	SPG

Plastic Wing Nut Test Plug



- . Fits inside 3-1/2 cast iron cleanout
- . Plastic body and nut

Part No#	Size	Type
SIOTESTPLUG31/2	3-1/2"	SPG

IPS Flush Cleanout Plug



- . Designed to fit inside a cleanout with damaged threads

Part No#	Size	Type
IPSFLUSHCOPLUG2	2"	SPG
IPSFLUSHCOPLUG3	3"	SPG
IPSFLUSHCOPLUG31/2	3-1/2"	SPG
IPSFLUSHCOPLUG4	4"	SPG

Expandable Test Ball



- . Standard test ball used for a water test
- . Includes steel chain

Part No#	Size	Type
CHETESTBALL2	2"	SPG
CHETESTBALL3	3"	SPG
CHETESTBALL4	4"	SPG
CHETESTBALL6	6"	SPG

Expandable Test Plug



- . Unique test ball threads into a cleanout tee

Part No#	Size	Type
CHETESTPLUG2	2"	MPT
CHETESTPLUG3	3"	MPT
CHETESTPLUG4	4"	MPT

WATER STOP TOOLS

Extension Hose For Expandable Test Plug



- . Extension hose for Cherne test plugs and balls
- . Male and female end connections

Part No#	Size	Type
CHEEXTHOSE36	3'	Extension Hose

Air-Max Test Pump



- . Test pump with gauge
- . Durable, non-kink hose

Part No#	Description	Type
CHEESTPUMP	Test Pump	Steel

Small Complete Jet Swet Kit



- . Kit sizes include 1/2", 3/4" & 1"

Part No#	Jet Swet Part#	Description
JETKIT1/2	2100	Jet Swet Kit

Large Complete Jet Swet Kit



- . Kit sizes include 1/2", 3/4", 1", 1-1/4", 1-1/2" & 2"

Part No#	Jet Swet Part#	Description
JETKITFULL	6100	Jet Swet Kit

Jet Swet Tool



- . Allows you to solder and glue pipes together without draining an entire water system
- . Works with gate and full port ball valves

Part No#	Jet Swet Part#	Size
JET1/2	50	1/2"
JET3/4	75	3/4"
JET1	100	1"
JET11/4	125	1-1/4"
JET11/2	150	1-1/2"
JET2	200	2"

Replacement Rubber Tip For Jet Swet Tool



- . Replacement rubber tips for Jet Swet tool

Part No#	Jet Swet Part#	Size
JET1/2RUB	12	1/2"
JET3/4RUB	34	3/4"
JET1RUB	101	1"
JET11/4RUB	114	1-1/4"
JET11/2RUB	112	1-1/2"
JET2RUB	202	2"

AIR TEST & GAUGES/VENTING

Pressure Gauge



- . 2-1/2" face size
- . To be used with air, water, oil or gas
- . Not for use with oxygen service

Part No#	Pressure Rating	Size
PAS15#GAUGE	15 PSI	1/4" MPT
PAS30#GAUGE	30 PSI	1/4" MPT
PAS60#GAUGE	60 PSI	1/4" MPT
PAS100#GAUGE	100 PSI	1/4" MPT
PAS200#GAUGE	200 PSI	1/4" MPT

Snifter Valve With Cap



- . 1/4" air valve with cap for a pressure test

Part No#	Size	Type
WALSNIFFERVALVE1/4	1/4"	MPT

Coin Vent



- . 1/8 standard male pipe threads
- . 125 PSI

Part No#	Description	Size
JONCOINVENT1/8	Coin Vent Only	1/8" MPT
SCHCOINVENTKEY	Coin Vent Key	Fits 1/8" Vent

Temperature/Pressure Gauge



- . Pressure rating from 0 - 75 PSI
- . Available in both bottom and back mount connections

Part No#	Size	Type
LEGTEMP/PRESSGAUGEST	1/2" MPT	Bottom Mount
LEGTEMP/PRESSGAUGEBA	1/2" MPT	Back Mount

Temperature Only Gauge With Probe



- . 3" face size
- . 1" probe and thermowell
- . Temperature range from 60 - 280°F

Part No#	Size	Type
LEGTEMP/PRESSGAUGEW	1/2"	MPT

Small Magic Vent



- . Dual PVC connection
- . Vents air out of a water system
- . Maximum horizontal DFU rating: 160

Part No#	Size	Type
SIOMAGICVENT	1-1/2" - 2"	H/SPG

Large Magic Vent



- . Dual PVC connection
- . Vents air out of a water system
- . Maximum horizontal DFU rating: 160

Part No#	Size	Type
OATMAGICVENT3"	2" - 3"	H/SPG

Small Magic Vent Box With Vent Included



- . Wall box includes magic vent
- . Vents air out of a water system
- . Maximum horizontal DFU rating: 160

Part No#	Description	Type
SIOMAGICVENTBOXKIT	Magic Vent Box Kit	H/SPG

Large Magic Vent Box Less Vent



- . Blank wall box for a magic vent (not included)
- . Includes wall grate

Part No#	Size	Type
OATMAGICVENTBOX	Magic Vent Box Only	Plastic

**LOOKING FOR DRYER VENTING SUPPLIES?
CHECK OUT THE SHEET METAL FITTINGS!**

Plastic Angle Roof Flashing



. Poly angle roof flashing

Part No#	Size	Type
JON2POLYROOFFLASH	2"	Plastic
JON3POLYROOFFLASH	3"	Plastic
JON4POLYROOFFLASH	4"	Plastic

Galvanized Angle Roof Flashing

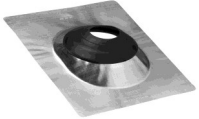

. Galvanized angle roof flashing

Part No#	Size	Type
JON4GALVROOFFLASH	4"	Galvanized

Lead Roof Flashing



. Full size: 12" x 12" x 14"

Part No#	Size	Type
LEADROOFFLASH3	3"	Lead

**LOOKING FOR B-VENT ROOF FLASHINGS?
CHECK OUT THE SHEET METAL FITTINGS!**

Brass Cow Tongue Downspout Drain



. Includes mounting bracket
. Standard FPT connection

Part No#	Size	Finish
SMI17703	3"	Brass
SMI17704	4"	Brass
SMI17706	6:	Brass

Plastic Roof Top Blocks



. Used to support piping running across a roof top
. Includes removable perforated strapping
. Can be used with threaded rod or screws and bolts

Part No#	Description	Type
RTB01	Roof Top Block	Plastic

PVC Roof Sumps Less Overflow



. No overflow included
. PVC dome strainer

Part No#	Size	Type
SIO3ROOFSUMP	3"	PVC
SIO4ROOFSUMP	4"	PVC
SIO6ROOFSUMP	6"	PVC

PVC Roof Sumps With Overflow



. No overflow included
. PVC dome strainer

Part No#	Size	Type
SIO4OVERFLOWROOFSU	4"	PVC

Overflow Dam Only For PVC Roof Sump

Part No#	Size	Type
SIO6OVERFLOWKIT	For 6" Roof Sump	PVC

SUPPLY BOXES/ARRESTORS

Large Washing Machine Box With Valves



- . Wall mount washing machine box
- . Includes valves and arrestors

Part No#	Type	Type
OATWASHERBOXPEXW/A	Plastic Solid Box	PEX
OATWASHERBOXW/ARRE	Plastic Solid Box	Copper
OATFACEPLATEONLY	Replacement Frame Only	Plastic

Split Washing Machine Box With Valves



- . Wall mount washing machine box
- . Unique design allows to divide boxes between a stud
- . Includes valves and arrestors

Part No#	Type	Type
SIOPEXOXBOXW/HAMME	Plastic Split Box	PEX
SIOOXBOXW/HAMMER	Plastic Split Box	Copper

Ice Maker Supply Box



- . Wall mount appliance box for ice maker
- . Includes supply valve and air arrestor

Part No#	Description	Type
SIOPEXICEMAKERBOX	PEX Ice Maker Box	PEX
SIOOXBOXW/HAMMER	Copper Ice Maker Box	Copper

Inline Mini Hammer Arrestors



- . Absorbs leftover air in a water piping system
- . Compression connection for plastic or copper lines

Part No#	Size	Type
SIO1/4INLINERESTER	1/4"	Mcomp x Mcomp
SIO3/8INLINERESTER	3/8"	Mcomp x Mcomp

Washing Machine Hammer Arrestor



- . Usually installed to a boiler drain valve and washing machine hose
- . Absorbs leftover air in a water piping system

Part No#	Size	Type
SIO660HBLAUNDRY	3/4"	MHT x FHT

Mini Hammer Arrestor



- . Absorbs leftover air in a water piping system
- . Typical residential use

Part No#	Size	Type
SIOMINIRESTER1/2	1/2"	Copper
SIOPEXMINIRESTER1/2	1/2"	PEX
SIOCPVCMINIRESTER1/2	1/2"	CPVC

Large Hammer Arrestor - Copper Sweat



- . Copper sweat connection
- . Typically used in commercial applications

Part No#	Size	Fixture Unit Value
SIOHAMRESTER1/2A	1/2"	1-11
SIOHAMRESTER3/4B	3/4"	12-32
SIOHAMRESTER1C	1"	33-60

Large Hammer Arrestor - MPT Connection



- . Standard MPT connection
- . Typically used in commercial or industrial applications

Part No#	Size	Fixture Unit Value
SIOHAMRESTER1DS	1"	61-113
SIOHAMRESTER1E	1"	114-154

WATER COOLERS & PARTS

Elkay Wall Mount ADA Old Style Cooler



- . ADA compliant
- . Push bars on front and both sides for easy activation
- . 8 GPH

Part No#	Elkay Part#	Color
ELKEHFS8L1Z	EHFS8L1Z	Light Gray Granite

Elkay Wall Mount ADA New Style Cooler



- . ADA compliant
- . Push bars on front and both sides for easy activation
- . 8 GPH

Part No#	Elkay Part#	Color
ELKEZS8L	EZS8L	Light Gray Granite

Elkay Wall Mount Bi-Level ADA Cooler



- . ADA compliant
- . Includes two bi-level stations
- . Push bars on front and both sides for easy activation
- . 8 GPH

Part No#	Elkay Part#	Color
ELKEZSTL8LC	EZSTL8LC	Light Gray Granite

Elkay Wall Mount ADA Cooler With Bottle Filler



- . ADA compliant
- . Includes single station with bottle filler
- . Push bars on front and both sides for easy activation
- . 8 GPH

Part No#	Elkay Part#	Color
ELKLZS8WSLP	LZS8WSLP	Light Gray Granite

Elkay Wall Mount Bi-Level ADA With Bottle Filler



- . ADA compliant
- . Includes two bi-level stations with one including bottle filler
- . Push bars on front and both sides for easy activation
- . 8 GPH

Part No#	Elkay Part#	Color
ELKLZSTL8WSLP	LZSTL8WSLP	Light Gray Granite

Replacement Filters For Bottle Filler



- . Replacement filter for Elkay bottle filler style coolers
- . Should be replaced every 3,000 gallons or 1 year after installation

Part No#	Elkay Part#	Type
ELK51300C	51300C	Filter

New Style Solenoid Valve



- . Solenoid for post July 2008 water coolers
- . Built in Y-strainer and regulator

Part No#	Elkay Part#	Size
ELK98466C	98466C	1/4

Old Style Solenoid Valve



- . Solenoid for pre July 2008 water coolers
- . Built in Y-strainer and regulator

Part No#	Elkay Part#	Size
ELK35981C	35981C	1/4

Valve Regulator



- . For push bar water coolers
- . Cartridge only

Part No#	Elkay Part#	Type
ELK61314C	61314C	Regulator

Regulator Kit With Brass Retaining Nut



- . Includes regulator housing, regulator, and brass nut

Part No#	Elkay Part#	Type
ELK98733C	98733C	Regulator Kit

Regulator Kit With Tubes



- . Includes regulator housing, regulator, supply tubes, and brass nut

Part No#	Elkay Part#	Type
ELK98732C	98732C	Regulator Kit

Regulator Housing Kit (Less Tubes)



- . Includes regulator housing and tubes

Part No#	Elkay Part#	Type
ELK92450C	92450C	Regulator Housing

Spanner Wrench



. Used to take the cartridge retaining nut out of the cartridge regulator holder

Part No#	Elkay Part#	Type
ELK36158000	36158000	Wrench

Flexi-Guard Bubbler Kit



. Includes bubbler head, nut and tubing

Part No#	Elkay Part#	Type
ELK92715C	92715C	Bubbler Kit

Water Inlet Strainer



. Replacement strainer for the water inlet of a drinking fountain
. Catches any sediment that could damage the valve

Part No#	Elkay Part#	Type
ELK55996C	55996C	Strainer

Plastic Complete Ice Maker Kit



. Kit includes valve, tubing and compression fittings

Part No#	Size	Type
JONICEMAKERKIT	1/4" x 25'	Plastic

Saddle Valve



. Saddle valve kit includes valve, saddles and hardware

Part No#	Size	Description
PASSELTAPINGSADDLE	1/4"	Saddle Valve
JONAMANNASADDLE	1/4"	Brass Saddle Only

Humidifier Valve



. Needle style valve

Part No#	Size	Type
JON1/8NEEDLEVALVE	1/8" x 1/4"	MPT x MComp

Watts House Filter Housing



. Complete house filter housing only
. Filters sold separately

Part No#	Type	Size
WATFTRHOUSING1/2	Plastic	1/2" FPT
WATFTRHOUSING3/4	Plastic	3/4" FPT

Watts Sediment Filter



. 20 microns filtration rating
. Collects sediment particles

Part No#	Watts Part#	Type
WATSEDIMENTFILTER	PWPL10M20	Sediment Filter

Watts Carbon Filter



. 5 microns filtration rating
. Also known as a taste and odor filter

Part No#	Watts Part#	Type
WATCHARFILTER	PWCB10P	Carbon Filter

Watts Ice Maker Filter



. Inline ice maker filter
. Manages taste and odor

Part No#	Watts Part#	Size
WATICEFILTER1/4	PWILGAC10	1/4" FPT

Bracket For House Filter Housing



. Plastic mounting bracket for Watts filter housing

Part No#	Description	Type
WATMOUNTBRACKET	Filter Housing Bracket	Plastic

Wrench For House Filter Housing



. Installation and removal wrench for Watts filter housing

Part No#	Description	Type
WATFTRWRENCH	Filter Housing Tool	Plastic

Stainless Steel Grab Bars



- . 1-1/2" diameter
- . Standard ADA compliant sizes: 18", 36", 42"

Part No#	Size	Type
ELCGRABBAR12	12"	Stainless Steel
ELCGRABBAR18	18"	Stainless Steel
ELCGRABBAR24	24"	Stainless Steel
ELCGRABBAR30	30"	Stainless Steel
ELCGRABBAR32	32"	Stainless Steel
ELCGRABBAR36	36"	Stainless Steel
ELCGRABBAR42	42"	Stainless Steel
ELCGRABBAR48	48"	Stainless Steel

Velcro Style Trap Cover



- . Easy to use trap cover
- . Covers trap and supply valves

Part No#	Description	Type
IPSTRAPWRAPBAG	Bag Style Trap Wrap	Rubber

Molded Style Trap Cover



- . Pre-Molded rubber trap cover
- . Covers trap and supply valves

Part No#	Description	Type
IPSTRAPWRAPBOX	Box Style Trap Wrap	Rubber

Plastic Access Panels



- . White plastic access panel

Part No#	Size	Type
SIOSMALLACCESSPANEL	8" x 8"	Plastic
SIOLARGEACCESSPANEL	14" x 14"	Plastic

ADA Hand Sink Tempering Valve



- . Mixes hot and cold water usually in commercial applications to reduce the risk of scalding
- . ASSE 1070
- . Compact design to fit under a lavatory
- . Lead free

Part No#	Size	Type
WATUSG3/8	3/8"	Mcomp

Inline Tempering Valve



- . Mixes hot and cold water usually in commercial applications to reduce the risk of scalding
- . ASSE 1070

Part No#	Size	Type
WATMMVUS1/2	1/2"	Copper
WATMMVUS1/2PEX	1/2"	PEX
WATMMVUS3/4	3/4"	Copper
WATMMVUS1	1"	Copper

WALL ESCHUTCHEONS/CLEANOUT COVERS

Chrome Solid Wall Escutcheon



. Chrome plated

Part No#	Fits	Size
PAS5/8SPINNING	1/2" CTS	5/8" OD
PAS7/8SPINNING	3/4" CTS 1/2" IPS	7/8" OD
PAS3/8IPSPINNING	3/8" IPS	—
PAS1/2IPSPINNING	3/4" CTS 1/2" IPS	7/8" OD

Chrome Flexible Split Floor & Ceiling Plates



. Chrome plated
. Plastic split design

Part No#	Fits	Size
PAS1/2COPF&CPLATE	1/2" CTS 3/8" IPS	5/8" OD
PAS3/4COPF&CPLATE	3/4" CTS 1/2" IPS	7/8" OD
PAS1COPF&CPLATE	1" CTS	1-1/8" OD
PAS11/4COPF&CPLATE	1-1/4" CTS	1-3/8" OD
PAS11/2COPF&CPLATE	1-1/2" CTS 1-1/4" IPS	1-5/8" OD
PAS2COPF&CPLATE	2" CTS	2-1/8" OD
PAS1/2IPF&CPLATE	3/4" CTS 1/2" IPS	1/2" IPS
PAS3/4IPF&CPLATE	3/4" IPS	3/4" IPS
PAS1IPF&CPLATE	1" IPS	1" IPS
PAS11/4IPF&CPLATE	1-1/2" CTS 1-1/4" IPS	1-1/4" IPS
PAS11/2IPF&CPLATE	1-1/2" IPS	1-1/2" IPS
PAS2IPF&CPLATE	2" IPS	2" IPS
WAL21/2IPF&CPLATE	2-1/2" IPS	2-1/2" IPS
PAS3IPF&CPLATE	3" IPS	3" IPS
PAS4IPF&CPLATE	4" IPS	4" IPS

PVC Deep Box Escutcheons



. White plastic
. Bell Design

Part No#	Fits	Size
SIOPVCDEEPSPIN11/4	1-1/4 CTS	1-3/8" OD
SIOPVCDEEPSPIN11/2	1-1/2 CTS	1-5/8" OD

Chrome Deep Box Escutcheons



. Chrome plated
. Bell Design

Part No#	Fits	Size
PAS11/4DEEPBOXSPIN	1-1/4 CTS	1-3/8" OD
PAS11/2DEEPBOXSPIN	1-1/2 CTS	1-5/8" OD

Flat Cleanout Cover Less Screw



. Cleanout cover typically used to cover a wall cleanout
. Machine screw not included

Part No#	Size	Type
SIOC/OCOVER4SS	4"	Stainless Steel
SIOC/OCOVER5SS	5"	Stainless Steel
SIOC/OCOVER6SS	6"	Stainless Steel
SIOC/OCOVER8SS	8"	Stainless Steel
SIOC/OCOVER10SS	10"	Stainless Steel
SIOC/OCOVER12SS	12"	Stainless Steel

Cleanout Cover Machine Screws



. 1/4-20 style machine screw
. Flat Head

Part No#	Size	Type
SIOC/OSCREW11/2	1-1/2"	Stainless Steel
SIOC/OSCREW2	2"	Stainless Steel
SIOC/OSCREW3	3"	Stainless Steel
SIOC/OSCREW4	4"	Stainless Steel
SIOC/OSCREW6	6"	Stainless Steel

Dome Style Cleanout Cover



. Chrome plated
. Used to cover exposed cleanouts

Part No#	Size	Type
EVE51/4DOMECOVER	5-1/4"	Chrome
EVE71/4DOMECOVER	7-1/4"	Chrome

PIPE INSULATION

Foam Pipe Insulation



- . Split style for easy installation
- . 6' lengths
- . 1/2" thick wall

Part No#	Size	Copper	IPS
INSFOAM5/8X6	5/8"	1/2"	3/8"
INSFOAM7/8X6	7/8"	3/4"	1/2"
INSFOAM11/8X6	1-1/8"	1"	3/4"
INSFOAM13/8X6	1-3/8"	1-1/4"	1"
INSFOAM15/8X6	1-5/8"	1-1/2"	1-1/4"
INSFOAM17/8X6	1-7/8"		1-1/2"
INSFOAM21/8X6	2-1/8"	2"	
INSFOAM23/8X6	2-3/8"		2"
INSFOAM25/8X6	2-5/8"	2-1/2"	
INSFOAM31/8X6	3-1/8"	3"	
INSFOAM31/2X6	3-1/2"		3"
INSFOAM41/8X6	4-1/8"	4"	
INSFOAM41/2X6	4-1/2"		4"

Fiberglass Pipe Insulation



- . 3' lengths
- . 1/2" thick wall

Part No#	Size	Copper	IPS
INSFIBRGLASS5/8x1/2x	5/8"	1/2"	3/8"
INSFIBRGLASS7/8x1/2x	7/8"	3/4"	1/2"
INSFIBRGLASS11/8x1/2	3/4"	1"	3/4"

90 Degree Elbow For Fiberglass Insulation

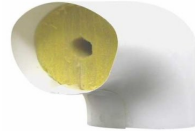

- . Zeston elbow for fiberglass insulation

Part No#	Size	Type
INSZESTONELL3	1/2" - 1"	Fiberglass

Tape For Fiberglass Insulation



- . Seal tape for fiberglass insulation
- . 100' roll

Part No#	Size	Color
INSFIBRGLASSTAPE1	1" Wide	White
INSFIBRGLASSTAPE3	3" Wide	White

PIPE HEATING WIRE

FROSTEX Heat Wire

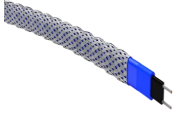

- . Can not be exposed to water
- . 50' single circuit length per plug kit

Part No#	Description	Size
FROSSHEATROLL100	FROSTEX Heat Wire	100' Roll

. Heat wire also available cut to requested length. Price charged per foot.
All wire cut to size is non returnable.

FROSTEX Heat Wire Plug Kit



- . Plug rating: 15A 120V
- . Includes gel end cap seals

Part No#	Description	FROSTEX Part#
FROPLUGKIT	FROSTEX 9800 Plug Kit	9800

RAYCHEM PLUS Heat Wire



- . Can not be exposed to water
- . Circuit length for 15A breaker per plug kit: 125' - 150'

Part No#	Description	Size
RAYSSHEATTAPEROLL	RAYCHEM PLUS Heat Wire	250' Roll

RAYCHEM WET Heat Wire

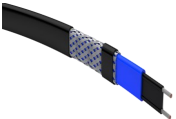

- . Protective rubber coating allows water exposure
- . Circuit length for 15A breaker per plug kit: 125' - 150'

Part No#	Description	Size
RAYWETBLKROLL	RAYCHEM WET Heat Wire	250' Roll

. Heat wire also available cut to requested length. Price charged per foot.
All wire cut to size is non returnable.

RAYCHEM Heat Wire Plug Kits



- . Power kits for RAYCHEM heat wire
- . Available in plug in style and direct wire
- . Includes gel end cap seals

Part No#	Description	RAYCHEM Part#
RAYDIRRECTWIREPOWER	Hard Wire Plug Kit	H-900
RAYGFIPLUGKIT	Plug In Kit	H-908

RAYCHEM Heat Wire Tee Splice Kit



- . Connects RAYCHEM heat wire
- . Includes gel end cap seals

Part No#	Description	RAYCHEM Part#
RAYTEEKIT	Splice Kit	H-910

RAYCHEM Heat Wire Gel End Caps



- . Used to cap off the end of RAYCHEM heat wire

Part No#	Description	RAYCHEM Part#
RAYENDCAP	Gel End Caps	H-912

RAYCHEM Heat Wire Roof Clips



- . Roof clips used to mount heat wire

Part No#	Description	RAYCHEM Part#
RAYROOFCLIP EACH	Heat Wire Roof Clips	H-914

BASEBOARD HEATING

Complete Baseboard Heating Unit



- . Slantfin #30 baseboard unit
- . Residential Use
- . Shipped complete in box

Part No#	Size	Color
SLA2COMPLETE	2'	White
SLA3COMPLETE	3'	White
SLA4COMPLETE	4'	White
SLA5COMPLETE	5'	White
SLA6COMPLETE	6'	White
SLA7COMPLETE	7'	White
SLA8COMPLETE	8'	White

Baseboard Heating Unit Cover Only



- . Slantfin #30 baseboard cover only

Part No#	Size	Color
SLA4COVERONLY	4'	White
SLA5COVERONLY	5'	White
SLA6COVERONLY	6'	White
SLA7COVERONLY	7'	White
SLA8COVERONLY	8'	White

Baseboard Heating Elbows



- . 90 degree elbows for baseboard heating units

Part No#	Type	Color
SLAOUTSIDECORNER	Outside	White
SLAINSIDECORNER	Inside	White

Baseboard Heating End Caps



- . End caps for baseboard heating units

Part No#	Type	Color
SLALHENDCAP	Left Hand	White
SLARHENDCAP	Right Hand	White

Coin Vent



- . 1/8" standard male pipe threads
- . 125 PSI

Part No#	Description	Size
JONCOINVENT1/8	Coin Vent Only	1/8" MPT
SCHCOINVENTKEY	Coin Vent Key	Fits 1/8" Vent

Baseboard Tee



- . 90 degree elbow with 1/8" FPT tapping usually for a coin vent
- . Most typically used for baseboard heating
- . Lead free

Part No#	Size	Type
COPBASETEE3/4x1/8	3/4" x 1/8" x 3/4"	C x FPT x C
COPBASETEE1x1/8x1	1" x 1/8" x 1"	C x FPT x C

COMPANION FLANGES & GASKETS

Flange Bolt Kit



. Bolt kit includes fiber ring gasket and hardware

Part No#	Size	Type
WAL21/2BOLTKIT	2-1/2"	Fiber
WAL3BOLTKIT	3"	Fiber
WAL4BOLTKIT	4"	Fiber
WAL6BOLTKIT	6"	Fiber
WAL8BOLTKIT	8"	Fiber

Full Face Rubber Gasket



. Rubber full face gaskets for flanges

Part No#	Size	Type
WAL21/2RUBBERGASKET	2-1/2"	Rubber
WAL3RUBBERGASKET	3"	Rubber
WAL4RUBBERGASKET	4"	Rubber

Red Rubber Gasket Material



. Durable rubber material
. Cut to size to make your own gaskets

Part No#	Size	Material
WALGASKETMAKER	6" x 6" x 3/32"	Red Rubber

Fiber Ring Gasket



. Fiber ring gasket for flanges

Part No#	Size	Type
JON21/2FIBERRINGGASK	2-1/2"	Fiber
JON3FIBERRINGGASKET	3"	Fiber
JON4FIBERRINGGASKET	4"	Fiber
JON6FIBERRINGGASKET	6"	Fiber

Cast Companion Flange



. Cast brass companion flange accepts copper pipe
. Gaskets and bolts not included
. Lead free

Part No#	Size	Type
COPCOMPFLANGE21/2	2-1/2"	C
COPCOMPFLANGE3	3"	C
COPCOMPFLANGE4	4"	C

Bolt Insulators



Part No#	Size	Length
LEGBOLTINSULATORS	301-421	

Cast Iron Companion Flange



. Extra heavy cast iron companion flanges

Part No#	Size	Type
CASFLANGE2x6	2" x 6"	Cast Iron
CASFLANGE21/2x7	2-1/2" x 7"	Cast Iron
CASFLANGE3x71/2	3" x 7-1/2"	Cast Iron
CASFLANGE4x9	4" x 9"	Cast Iron
CASFLANGE6x11	6" x 11"	Cast Iron

**LOOKING FOR A GASKET OR REPLACEMENT
HARDWARE NOT LISTED IN THIS CATALOG?
GIVE US A CALL WE MAY STILL HAVE IT!**

SECTION 9 - BRACKETS & HANGERS

Nail Plates & Pipe Support	185-186
CTS Hangers	186-189
IPS Hangers	189-190
Strut & Accessories	191-192

Stud Guards Less Tabs



- . For metal studs
- . Protects piping and wiring from nails or screws

Part No#	Size	Gauge
NP11/2X6HOLES	1-1/2 x 6"	16
NP5X8BOCAHOLES	5" x 8"	16
NP5X18BOCAHOLES	5" X 18"	16

Stud Guards With Tabs



- . Includes metal tabs for wood studs
- . Protects piping and wiring from nails or screws

Part No#	Size	Gauge
NP11/2X3TABS	1-1/2 x 3"	16
NP11/2X6TABS	1-1/2 x 6"	16
NP5X8BOCATABS	5" x 8"	16

Stud Shoe



- . 18 gauge stud shoe
- . Accommodates 2" DWV pipe or smaller

Part No#	Size	Gauge
EMCSTUDSHOE	2" DWV	18

Copper Support Bracket



- . For use on sinks, lavatories or other fixtures
- . For use with copper piping

Part No#	Description	Size (CTS)
HOL101-18	18" Copper Bracket	1/2
HOL107-18	18" Copper Bracket	1/2, 3/4, 1
HOL150-20	20" Copper Bracket	1/2, 3/4
HOL150-26	26" Copper Bracket	1/2, 3/4
HOL102-26	26" Copper Bracket	3/4, 1
HOL108-26	26" Copper Bracket	1/2, 3/4, 1

Copper Flat Solder Bracket

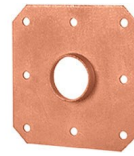

- . Idea for copper piping penetrating through the floor

Part No#	Description	Size (CTS)
SIICOPTWOHOLEBRACKET	Flat Copper Bracket	1/2

Copper Toilet Carrier Bracket



- . Heavy duty bracket mounts directly to 4 bolt toilet carrier
- . For 1" flush valve support on wall hung toilet carriers

Part No#	Description	Size (CTS)
HOL114-CO	Toilet Carrier Bracket	1

Copper Pipe-On-Pipe Bracket



- . Hose clamp attaches to vent pipe and also support nearby 1/2 or 3/4 copper pipes

Part No#	Description	Size (CTS)
HOL111-S	Pipe-On-Pipe Bracket	1/2, 3/4



- . Hose clamp attaches to vent pipe and also support a 1/2 to 3" copper pipe

Part No#	Description	Size (CTS)
HOLV-2	Pipe-On-Pipe Bracket	1/2-3

SUPPORT BRACKETS/PEX HANGERS

Galvanized Support Bracket



- . For use on sinks, lavatories or other fixtures
- . For use copper, PEX or CPVC piping
- . For use with #701 inserts or metal stud pipe insulators

Part No#	Description	Size (CTS)
HOL103-18	18" Galvanized Bracket	1/2", 3/4", 1"

PEX Pipe Inserts For 103-18 Support Bracket



- . Pipe inserts for PEX piping
- . To be used with the #103-18 galvanized support bracket

Part No#	Description	Size (CTS)
HOL701	PEX Pipe Insert	1/2"

Thin Slider Bracket With Touchdown Clamps



- . Each bracket includes two touchdown clamps
- . Spreads from 9" - 16" openings

Part No#	Description	Size (CTS)
SIOSLIDERBRK	Thin Slider Bracker	1/4" - 1"

Thick Slider Bracket



- . Spreads from 11" - 18"

Part No#	Description	Gauge
SIOWIDESLIDERBRACKET	Thick Slider Bracket	22

Metal Stud Pipe Insulators



- . To be used when running pipe through metal studs
- . Use the metal stud punch tool for creating the stud holes
- . Can also be used with the #103-18 galvanized support bracket

Part No#	Size	Type
PIPETYTES1/2	1/2" CTS	Plastic
PIPETYTES3/4	3/4" CTS	Plastic
PIPETYTES1	1" CTS	Plastic

**LOOKING FOR THE METAL
STUD PUNCH TOOL? CHECK
OUT THE TOOLS SECTION!**

PEX Support Bends



- . Supports PEX at a 90 degree elbow
- . Includes screw holes for easy mounting

Part No#	Size	Type
PEXBENDSUPPORT1/2	1/2" CTS	Plastic
PEXBENDSUPPORT3/4	3/4" CTS	Plastic
PEXBENDSUPPORT1	1" CTS	Plastic

PEX Add A Hanger

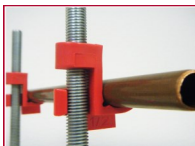

- . Supports CTS tubing while also accepting 3/8 threaded rod

Part No#	Size	Type
PIPADDAHANGER1/2	1/2" CTS	Plastic
PIPADDAHANGER3/4	3/4" CTS	Plastic
PIPADDAHANGER1	1" CTS	Plastic

Plastic Two Hole Suspension Clamps



- . Includes two drop ears for the ability to hang CTS tubing under a beam
- . May also be called a "mickey mouse clamp"

Part No#	Size	Type
SIOSUSPENCLAMP1/2	1/2" CTS	Plastic
SIOSUSPENCLAMP3/4	3/4" CTS	Plastic
SIOSUSPENCLAMP1	1" CTS	Plastic

Plastic Two Hole Strap



- . To be used to nail or screw CTS tubing to a wall or ceiling

Part No#	Size	Type
SIOPLTWOHOLE1/2	1/2" CTS	Plastic
SIOPLTWOHOLE3/4	3/4" CTS	Plastic
SIOPLTWOHOLE1	1" CTS	Plastic

CTS HANGERS

Plastic Talon Hanger



- . Easy single nail hanger for CTS tubing
- . Perfect for using on ceilings

Part No#	Size	Type
SIOTALON1/2	1/2" CTS	Plastic
SIOTALON3/4	3/4" CTS	Plastic
SIOTALON1	1" CTS	Plastic
SIOTALON1/2&3/4	1/2" CTS & 3/4" CTS	Plastic

Plastic Talon Hanger Master Bucket



- . Easy single nail hanger for CTS tubing
- . Convenient plastic master bucket for large projects

Part No#	Size	Quantity
SIOTALONBUCKET1/2	1/2" CTS	1600
SIOTALONBUCKET3/4	3/4" CTS	800
SIOTALONBUCKET1	1" CTS	400
SIOTALONBUCKETCOMBO	1/2" CTS & 3/4" CTS	1600

Copper Van Hanger



- . May also be called a "bell hanger"
- . Includes wood screws

Part No#	Size	Type
AMT6061/2	1/2" CTS	Copper
AMT6063/4	3/4" CTS	Copper
AMT6061	1" CTS	Copper

Copper Stand Off Hangers



- . Accepts 1/2 copper pipe to solder in between bracket and clamp to preferred length
- . Includes two hole bracket and clamp

Part No#	Size	Type
AMT6011/2	1/2" CTS	Copper
AMT6013/4	3/4" CTS	Copper
AMT6011	1" CTS	Copper
AMT60111/4	1-1/4" CTS	Copper
AMT60111/2	1-1/2" CTS	Copper
AMT6012	2" CTS	Copper

Copper Inso-Glide Hanger



- . Unique two hole style clamp with insulation for CTS tubing

Part No#	Size	Type
AMT6041/2	1/2" CTS	Copper/Rubber
AMT6043/4	3/4" CTS	Copper/Rubber
AMT6041	1" CTS	Copper/Rubber

Copper Wire Hooks



- . Copper nail hooks for CTS tubing

Part No#	Size	Type
EMCCOPWIRE1/2X4	1/2" x 4" CTS	Copper
EMCCOPWIRE1/2X6	1/2" x 6" CTS	Copper
EMCCOPWIRE3/4x21/2	3/4" x 2-1/2" CTS	Copper
EMCCOPWIRE3/4x4	3/4" x 4" CTS	Copper
EMCCOPWIRE3/4x6	3/4" x 6" CTS	Copper
EMCCOPWIRE1x4	1" x 4" CTS	Copper
EMCCOPWIRE1x6	1" x 6" CTS	Copper

Copper Two Hole Clamp



- . To be used to nail or screw CTS tubing to a wall or ceiling

Part No#	Description	Type
EMCCOPTWOHOLE1/4	1/4" CTS	Copper
EMCCOPTWOHOLE1/2	1/2" CTS	Copper
EMCCOPTWOHOLE3/4	3/4" CTS	Copper
EMCCOPTWOHOLE1	1" CTS	Copper
EMCCOPTWOHOLE11/4	1-1/4" CTS	Copper
EMCCOPTWOHOLE11/2	1-1/2" CTS	Copper
EMCCOPTWOHOLE2	2" CTS	Copper

Copper Split Ring Hanger



- . To be used with CTS tubing
- . Accepts 3/8 threaded rod

Part No#	Size	Type
PHDCOPSPLITRING1/2	1/2" CTS	Copper
PHDCOPSPLITRING3/4	3/4" CTS	Copper
PHDCOPSPLITRING1	1" CTS	Copper
PHDCOPSPLITRING11/4	1-1/4" CTS	Copper
PHDCOPSPLITRING11/2	1-1/2" CTS	Copper
PHDCOPSPLITRING2	2" CTS	Copper

Copper Riser Clamp



- . To be used with CTS tubing when penetrating through a ceiling

Part No#	Size	Type
PHDCOPRISER1/2	1/2" CTS	Copper
PHDCOPRISER3/4	3/4" CTS	Copper
PHDCOPRISER1	1" CTS	Copper
PHDCOPRISER11/4	1-1/4" CTS	Copper
PHDCOPRISER11/2	1-1/2" CTS	Copper
PHDCOPRISER2	2" CTS	Copper
PHDCOPRISER21/2	2-1/2" CTS	Copper
PHDCOPRISER3	3" CTS	Copper
PHDCOPRISER4	4" CTS	Copper

Copper Auto Grip Hanger



- . To be used when hanging CTS tubing from a ceiling
- . Accepts 3/8 threaded rod (except where noted)

Part No#	Size	Type
PHDCOPAUTOGRIP1/2	1/2" CTS	Copper
PHDCOPAUTOGRIP3/4	3/4" CTS	Copper
PHDCOPAUTOGRIP1	1" CTS	Copper
PHDCOPAUTOGRIP11/4	1-1/4" CTS	Copper
PHDCOPAUTOGRIP11/2	1-1/2" CTS	Copper
PHDCOPAUTOGRIP2	2" CTS	Copper
PHDCOPAUTOGRIP21/2	2-1/2" CTS	Copper
PHDCOPAUTOGRIP3	3" CTS	Copper
PHDCOPAUTOGRIP4	4" CTS (1/2" Nut)	Copper

CTS Plastic J-Hooks



- . To be used when nailing CTS tubing along a beam
- . Includes nails

Part No#	Size	Type
SIOPVCJHOOK1/2	1/2" CTS	Plastic
SIOPVCJHOOK3/4	3/4" CTS	Plastic
SIOPVCJHOOK1	1" CTS	Plastic

IPS Plastic J-Hooks



- . To be used when nailing IPS tubing along a beam
- . Includes nails

Part No#	Size	Type
SIOPVCJHOOK11/2	1-1/2" IPS	Plastic
SIOPVCJHOOK2	2" IPS	Plastic
SIOPVCJHOOK3	3" IPS	Plastic
SIOPVCJHOOK4	4" IPS	Plastic

Plastic J-Hook For Schedule 30 Pipe



- . To be used when nailing schedule 30 tubing along a beam
- . Includes nails

Part No#	Size	Type
SIOPVCJHOOK3SCH30	3" Schedule 30	Plastic

Plastic Stick-Em-Up Hanger



- . I-beam support for vent pipe
- . Corrosion resistant

Part No#	Size	Color
SIOSTICKEMUP11/2-2	1-1/2" - 2" DWV	White

Plastic Zipstick Hanger



- . Ideal for hanging DWV piping and insulation
- . Easy to release strap

Part No#	Size	Color
SIOZIPSTICKS	1" CTS - 6" IPS	White

Tomahawk Ground Clamp



- . Polyethylene head with steel body
- . Holds pipe in place during concrete pouring

Part No#	Size	Length
SIOTOMAHAWKSTRAP	1-1/2" - 4" DWV	26"

Copper Band Iron



- . Copper hanger strap with holes

Part No#	Gauge	Size
EMCCOPBANDIRON10	24	10'

Galvanized Band Iron



- . Galvanized hanger strap with holes

Part No#	Gauge	Size
EMCGALBANDIRON10	24	10'
EMCGALBANDIRON100	24	100'

Plastic Band Iron



- . Plastic hanger strap with holes

Part No#	Description	Size
WALBANDIRONPLASTIC	Plastic Band Iron	100'

Galvanized Wire Hooks



- . Galvanized steel nail hooks for IPS tubing

Part No#	Size	Type
EMCWIREHOOK1/2X4	1/2" x 4" IPS	Galvanized
EMCWIREHOOK1/2X6	1/2" x 6" IPS	Galvanized
EMCWIREHOOK3/4X4	3/4" x 4" IPS	Galvanized
EMCWIREHOOK3/4X6	3/4" x 6" IPS	Galvanized
EMCWIREHOOK1X4	1" x 4" IPS	Galvanized
EMCWIREHOOK1X6	1" x 6" IPS	Galvanized

Galvanized Two Hole Clamp



- . To be used to nail or screw IPS tubing to a wall or ceiling

Part No#	Size	Type
EMCGALTWOHOLE1/2	1/2" IPS	Galvanized
EMCGALTWOHOLE3/4	3/4" IPS	Galvanized
EMCGALTWOHOLE1	1" IPS	Galvanized
EMCGALTWOHOLE11/2	1-1/4" IPS	Galvanized
EMCGALTWOHOLE11/2	1-1/2" IPS	Galvanized
EMCGALTWOHOLE2	2" IPS	Galvanized
EMCGALTWOHOLE21/2	2-1/2" IPS	Galvanized
EMCGALTWOHOLE3	3" IPS	Galvanized
EMCGALTWOHOLE4	4" IPS	Galvanized

Galvanized Split Ring Hanger



- . To be used with IPS tubing
- . Accepts 3/8 threaded rod (except where noted)

Part No#	Size	Type
PHDGALVSPLITRING1/2	1/2" IPS	Galvanized
PHDGALVSPLITRING3/4	3/4" IPS	Galvanized
PHDGALVSPLITRING1	1" IPS	Galvanized
PHDGALVSPLITRING11/4	1-1/4" IPS	Galvanized
PHDGALVSPLITRING11/2	1-1/2" IPS	Galvanized
PHDGALVSPLITRING2	2" IPS	Galvanized
PHDGALVSPLITRING3	3" IPS (1/2" Nut)	Galvanized

Steel Riser Clamps



. To be used with IPS tubing when penetrating through a ceiling

Part No#	Size	Type
PHDSTEELRISER1/2	1/2" IPS	Steel
PHDSTEELRISER3/4	3/4" IPS	Steel
PHDSTEELRISER1	1" IPS	Steel
PHDSTEELRISER11/4	1-1/4" IPS	Steel
PHDSTEELRISER11/2	1-1/2" IPS	Steel
PHDSTEELRISER2	2" IPS	Steel
PHDSTEELRISER21/2	2-1/2" IPS	Steel
PHDSTEELRISER3	3" IPS	Steel
PHDSTEELRISER4	4" IPS	Steel
PHDSTEELRISER6	6" IPS	Steel
PHDSTEELRISER8	8" IPS	Steel
PHDSTEELRISER10	10" IPS	Steel
PHDSTEELRISER12	12" IPS	Steel

Galvanized Auto Grip Hangers



. To be used when hanging CTS tubing from a ceiling

. Accepts 3/8 threaded rod (except where noted)

Part No#	Size	Type
PHDGALVAUTOGRIP1/2	1/2" IPS	Galvanized
PHDGALVAUTOGRIP3/4	3/4" IPS	Galvanized
PHDGALVAUTOGRIP1	1" IPS	Galvanized
PHDGALVAUTOGRIP11/4	1-1/4" IPS	Galvanized
PHDGALVAUTOGRIP11/2	1-1/2" IPS	Galvanized
PHDGALVAUTOGRIP2	2" IPS	Galvanized
PHDGALVAUTOGRIP21/2	2-1/2" IPS	Galvanized
PHDGALVAUTOGRIP3	3" IPS	Galvanized
PHDGALVAUTOGRIP4	4" IPS	Galvanized
PHDGALVAUTOGRIP6	6" IPS (1/2" Nut)	Galvanized
PHDGALVAUTOGRIP8	8" IPS (1/2" Nut)	Galvanized

Steel Clevis Hangers



. To be used when hanging IPS tubing from ceiling

. Does not include anything to mount with

Part No#	Size	Type
PHDSTEELCLEVIS1/2	1/2" IPS	Steel
PHDSTEELCLEVIS3/4	3/4" IPS	Steel
PHDSTEELCLEVIS1	1" IPS	Steel
PHDSTEELCLEVIS11/4	1-1/4" IPS	Steel
PHDSTEELCLEVIS11/2	1-1/2" IPS	Steel
PHDSTEELCLEVIS2	2" IPS	Steel
PHDSTEELCLEVIS21/2	2-1/2" IPS	Steel
PHDSTEELCLEVIS3	3" IPS	Steel
PHDSTEELCLEVIS4	4" IPS	Steel
PHDSTEELCLEVIS5	5" IPS	Steel
PHDSTEELCLEVIS6	6" IPS	Steel
PHDSTEELCLEVIS8	8" IPS	Steel
PHDSTEELCLEVIS10	10" IPS	Steel

Galvanized Dresser Coupling



. Heavy duty construction

. Compression fittings tighten gasket to pipe for easy repair or connection

Part No#	Size	Type
LEG1/2DRESSERCOUP	1/2" IPS	Galvanized
LEG3/4DRESSERCOUP	3/4" IPS	Galvanized
LEG1DRESSERCOUP	1" IPS	Galvanized
LEG11/4DRESSERCOUP	1-1/4" IPS	Galvanized
LEG11/2DRESSERCOUP	1-1/2" IPS	Galvanized
LEG2DRESSERCOUP	2" IPS	Galvanized

STRUT & ACCESSORIES

Galvanized Green Coated Strut



- . Heavy duty steel strut
- . Green coated

Part No#	Size	Length
PHDSLOTTEDSTRUT13/16	13/16"	10'
PHDSLOTTEDSTRUT15/8	1-5/8"	10'

Strut Angle Bracket



- . Steel strut angle bracket

Part No#	Configuration	Type
PHDBRACKET2HOLE	2-Hole	Galvanized
PHDBRACKET4HOLE	4-Hole	Galvanized

Strut Nut With Spring



- . Steel square strut nut with spring

Part No#	Size	Type
PHDSPRINGNUT3/8	3/8"	Galvanized
PHDSPRINGNUT1/2	1/2"	Galvanized

Strut Nut Less Spring

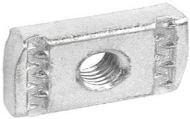

- . Steel square strut nut less spring

Part No#	Size	Type
PHDSTRUTNUT3/8	3/8"	Galvanized
PHDSTRUTNUT1/2	1/2"	Galvanized

Square Strut Washer



- . Steel square strut washer

Part No#	Size	Type
PHDWASHER3/8	3/8"	Galvanized
PHDWASHER1/2	1/2"	Galvanized

LOOKING FOR NUTS & BOLTS? CHECK OUT THE FASTENERS SECTION!

Copper Strut Clamps



- . Used when mounting CTS tubing to strut

Part No#	Size	Type
PHDCOPSTRUTCLMP1/2	1/2" CTS	Copper
PHDCOPSTRUTCLMP3/4	3/4" CTS	Copper
PHDCOPSTRUTCLMP1	1" CTS	Copper
PHDCOPSTRUTCLMP11/4	1-1/4" CTS	Copper
PHDCOPSTRUTCLMP11/2	1-1/2" CTS	Copper
PHDCOPSTRUTCLMP2	2" CTS	Copper
PHDCOPSTRUTCLMP21/2	2-1/2" CTS	Copper
PHDCOPSTRUTCLMP3	3" CTS	Copper
PHDCOPSTRUTCLMP4	4" CTS	Copper

Galvanized Strut Clamps



- . Used when mounting IPS tubing to strut

Part No#	Size	Type
PHDGALVSTRUTCLMP1/2	1/2" IPS	Galvanized
PHDGALVSTRUTCLMP3/4	3/4" IPS	Galvanized
PHDGALVSTRUTCLMP1	1" IPS	Galvanized
PHDGALVSTRUTCLMP11/4	1-1/4" IPS	Galvanized
PHDGALVSTRUTCLMP11/2	1-1/2" IPS	Galvanized
PHDGALVSTRUTCLMP2	2" IPS	Galvanized
PHDGALVSTRUTCLMP21/2	2-1/2" IPS	Galvanized
PHDGALVSTRUTCLMP3	3" IPS	Galvanized
PHDGALVSTRUTCLMP4	4" IPS	Galvanized
PHDGALVSTRUTCLMP5	5" IPS	Galvanized
PHDGALVSTRUTCLMP6	6" IPS	Galvanized
PHDGALVSTRUTCLMP8	8" IPS	Galvanized
PHDGALVSTRUTCLMP10	10" IPS	Galvanized

Galvanized Strut Clamps For Cast Iron

Part No#	Size	Type
PHDGALVSTRUTCLMP4CI	4-3/8" (Fits 4" Cast Iron)	Galvanized
PHDGALVSTRUTCLMP6CI	6-3/8" (Fits 6" Cast Iron)	Galvanized

STRUT & ACCESSORIES/THREADED ROD

Plastic Roof Top Blocks



- . Used to support piping running across a roof top
- . Includes removable perforated strapping
- . Can be used with threaded rod or screws and bolts

Part No#	Description	Type
RTB01	Roof Top Block	Plastic

Strut Wing Style Base Clamp



- . Strut bracket includes wings for easy mounting

Part No#	Description	Type
PHDSTRUTWINGBRKT	Strut Wing Bracket	Steel

Window Style Beam Clamp



- . Beam clamp to be used when hanging 1-5/8 strut

Part No#	Description	Type
PHDSTRUTBEAMCLAMP	Strut Beam Clamp	Steel

Steel Beam Clamp



- . Clamps on to a ceiling beam to create a stand off style hanger
- . Accepts threaded rod

Part No#	Size	Type
PHDBEAMCLAMP3/8	3/8"	Galvanized
PHDBEAMCLAMP1/2	1/2"	Galvanized

Steel C Clamp



- . Similar to a beam clamp
- . Accepts threaded rod

Part No#	Size	Type
PHDCCLAMP1/2	1/2"	Steel

Threaded Rod



- . Zinc plated

Part No#	Size	Length
EMCTR3/8X6	3/8"	6'
EMCTR3/8X10	3/8"	10'
EMCTR1/2X6	1/2"	6'
EMCTR1/2X10	1/2"	10'

Galvanized Base Plates For Threaded Rod



- . Bracket mounts to a ceiling to create a stand off style hanger
- . Accepts threaded rod

Part No#	Size	Type
PHDGALVPLATES3/8	3/8"	Galvanized

Offset Hanger For Threaded Rod



- . Screws to a surface to create an offset for a stand off style hanger
- . Accepts threaded rod

Part No#	Size	Type
PASOFFSETEYESOCKET	3/8"	Galvanized

Madison Heights Plumbing & Heating Supply

SECTION 10 - HARDWARE & TOOLS

Fasteners & Anchor Kits	194-196
Tubing Cutters	197
Hole Saws & Drill Bits	198-200
Soldering Accessories	201-202
Hand Tools	203-208
Pipe Wrenches	209

Metal Flat Washers



- . Zinc plated
- . Includes plastic reusable box

Part No#	Size	Sell Qty
EMCFLATWAS1/4	1/4"	Each
EMCFLATWAS3/8	3/8"	Each
EMCFLATWAS1/2	1/2"	Each

Metal Fender Washers



- . Zinc plated
- . Includes plastic reusable box

Part No#	Size	Sell Qty
EMCFENWAS1/4X1	1/4" x 1"	Each
EMCFENWAS1/4X11/4	1/4" x 1-1/4"	Each
EMCFENWAS3/8X1	3/8" x 1"	Each
EMCFENWAS3/8X11/4	3/8" x 1-1/4"	Each
EMCFENWAS3/8X11/2	3/8" x 1-1/2"	Each
EMCFENWAS1/2X11/2	1/2" x 1-1/2"	Each

Metal Hex Nuts



- . Zinc plated
- . Includes plastic reusable box

Part No#	Size	Sell Qty
EMCHEXNUT1/4	1/4"-20	Each
EMCHEXNUT3/8	3/8"-16	Each
EMCHEXNUT1/2	1/2"-13	Each
EMCHEXNUT5/8	5/8"-11	Each

Metal Heavy Duty Hex Nuts



- . Zinc plated
- . Extra thick metal
- . Reusable plastic box

Part No#	Size	Sell Qty
EMCHEXNUT3/8HD	3/8-16	Each
EMCHEXNUT1/2HD	1/2-13	Each

Masonry Tapcon Screws



- . Pre drilled hole typically required
- . CARTON QUANTITIES ONLY

Part No#	Size	Sell Qty
EMCTAPCON1/4x11/4	1/4" x 1-1/4"	Carton Only/100
EMCTAPCON1/4x13/4	1/4" x 1-3/4"	Carton Only/100
EMCTAPCON1/4x21/4	1/4" x 2-1/4"	Carton Only/100
EMCTAPCON1/4x31/4	1/4" x 3-1/4"	Carton Only/50

Toggle Bolts



- . Zinc plated

Part No#	Size	Sell Qty
EMCTOGBOLT1/4x4	1/4" x 4"	Each
EMCTOGBOLT1/4x6	1/4" x 6"	Each
EMCTOGBOLT3/8x4	3/8" x 4"	Each
EMCTOGBOLT3/8x6	3/8" x 6"	Each
EMCTOGBOLTWING1/4	1/4" Toggle Only	Each

Setting Tool



- . Tool for drop in anchors

Part No#	Size	Sell Qty
EMCDST3/8TOOL	3/8"	Each
EMCDST1/2TOOL	1/2"	Each

Drop Anchor



- . Zinc plated
- . Can be used with wood or concrete
- . Pre drilled hole required

Part No#	Size	Sell Qty
EMCDA3/8	3/8"	Each
EMCDA1/2	1/2"	Each

Sheet Metal Screw



- . Zinc plated
- . Hex Head
- . CARTON QUANTITIES ONLY

Part No#	Size	Sell Qty
EMCSHESCREW1/2	8 x 1/2"	Carton only/100
EMCSHESCREW3/4	8 x 3/4"	Carton Only/100
EMCSHESCREW1	8 x 1"	Carton Only/100
EMCSHESCREW11/2	8 x 1-1/2"	Carton Only/100
EMCSHESCREW2	8 x 2"	Carton Only/100
EMCSHESCREW1/2M	8 x 1/2" (Master Case)	Carton Only/1000

Sheet Metal Screw With Self Drilling Head



- . Zinc plated
- . Hex head with self drilling tip
- . CARTON QUANTITIES ONLY

Part No#	Size	Sell Qty
EMCTKSCREW1/2	8 x 1/2"	Carton Only/100
EMCTKSCREW1	8 x 1"	Carton Only/100

Wood Screws With Flat Head



- . Zinc plated
- . Tapered Head
- . CARTON QUANTITIES ONLY

Part No#	Size	Sell Qty
EMCWOODSCR11/2	12 x 1-1/2"	Carton Only/100
EMCWOODSCR2	12 x 2"	Carton Only/100
EMCWOODSCR21/2	12 x 2-1/2"	Carton Only/100
EMCWOODSCR3	12 x 3"	Carton Only/100

Stove Bolt & Nut Kit



- . Zinc plated
- . Kit includes bolts and hex nuts
- . CARTON QUANTITIES ONLY

Part No#	Size	Sell Qty
EMCSB1/4 20x1/2	1/4-20 x 1/2"	Carton Only
EMCSB1/4 20x3/4	1/4-20 x 3/4"	Carton Only
EMCSB1/4 20x1	1/4-20 x 1"	Carton Only
EMCSB1/4 20x11/2	1/4-20 x 1-1/2"	Carton Only

Sammy Screws



- . Zinc plated
- . Accepts 3/8" threaded rod
- . CARTON QUANTITIES ONLY



Part No#	Size	Sell Qty
EMCSAMMYWOOD	1/4" X 2" (Wood)	Carton Only
EMCSAMMYWOODBIT	Red Tool For Wood	Each
EMCSAMMYCEMENT	1/4" x 2" (Masonry)	Carton Only
EMCSAMMYCEMENTBIT	Blue Tool For Masonry	Each
EMCSAMMYMETAL	1/4" x 2" (Metal)	Carton Only

Drive Pins



- . Zinc plated
- . 1/4" head with metal washer
- . CARTON QUANTITIES ONLY

Part No#	Size	Sell Qty
EMCHAMDRIVEPIN1	1/4" x 1"	Carton Only
EMCHAMDRIVEPIN11/4	1/4" x 1-1/4"	Carton Only
EMCHAMDRIVEPIN11/2	1/4" x 1-1/2"	Carton Only

Hammer Drive Anchor



- . Expansion style anchor

Part No#	Size	Sell Qty
EMCHD1/4x1	1/4" x 1"	Each
EMCHD1/4x11/4	1/4" x 1-1/4"	Each

Threaded Rod Coupling



- . Zinc plated
- . Used to connect two pieces of threaded rod

Part No#	Size	Sell Qty
EMTRCOUP3/8	3/8-16	Each
EMTRCOUP1/2	1/2-13	Each

Drywall Screws



- . Pan head
- . CARTON QUANTITIES ONLY

Part No#	Size	Sell Qty
EMCDW6X15/8	6 x 1-5/8"	Carton Only/100

Pan Head Self Drilling Screws



- . Zinc plated
- . Pan head with self drilling tip
- . CARTON QUANTITIES ONLY

Part No#	Size	Sell Qty
EMCWH8X1/2	8 x 1/2"	Carton Only/100
EMCWH8X1/2M	8 x 1/2" (Master Case)	Carton Only/1000

Hex Head Screw Kit



- . Combination hex head screw kit
- . Includes 5/16" magnetic drill bit
- . 5 different sizes of screws

Part No#	Type	Sell Qty
EMCHHCKIT	Screw Kit	Each

Tornado Screw Anchor Kit



- . Tornado screw kit includes 50 anchors and screws
- . Includes 1/4" Phillips insert bit
- . No pre drilling required

Part No#	Size	Sell Qty
EMCEZ8X11/4H	8 x 1-1/4"	Each

Anchor Kits



- . Kit contains equal amount of anchors and screws

Part No#	Size	Sell Qty
EMCEPA2	8 x 1"	Each
EMCEPA4H	10 x 1-1/4"	Each
EMCEPA6	14 x 1-1/4"	Each

TUBING CUTTERS

General AutoCut Tubing Cutter



- . Compact tubing cutter works in low clearance areas
- . Automatically tightens as you turn
- . Includes copper cutting wheel

Part No#	Size	Cuts
GENATC12	1/2"	Copper
GENATC34	3/4"	Copper
GENATC1	1"	Copper
GENATCWHEEL	Replacement Wheels	1 pack

Lenox Tight Spaces Tubing Cutter



- . Compact design for tight spaces
- . Stainless steel roller blades
- . Includes copper cutting wheel

Part No#	Size	Cuts
LEN1/2AUTOCUT	1/2"	Copper
LEN3/4AUTOCUT	3/4"	Copper
LEN1AUTOCUT	1"	Copper
LENAUTOCUTWHEELS	Replacement Wheels	2 pack

Lenox 3 Piece Tight Spaces Tubing Cutter Kit



- . Compact design for tight spaces
- . Stainless steel roller blades
- . Includes copper cutting wheel

Part No#	Size	Cuts
LENAUTOCUTKITCASE	1/2", 3/4", 1"	Copper

Lenox Copper Tubing Cutter



- . Easy to use cutter will not walk on pipe
- . Includes extra cutting wheel stored in handle
- . Includes copper cutting wheel or wheels

Part No#	Size	Cuts
LEN11/8TUBECUTTER	1/8"-1-1/8"	Copper
LEN13/8TUBECUTTER	1/8"-1-3/8"	Copper
LEN13/4TUBECUTTER	1/8"-1-3/4"	Copper
LEN25/8TUBECUTTER	1/8"-2-5/8"	Copper

Reed Mini Tubing Cutter



- . For use in tight spaces
- . Smooth, rounded body for comfortable grip
- . Includes copper cutting wheel

Part No#	Size	Cuts
REEDMC2CUTTER	1/8"-15/16"	Copper
REEDMC3CUTTER	1/8"-1-1/8"	Copper

Reed Tubing Cutter



- . Durable simple screw feed design
- . Large knob for easy adjustment
- . Includes copper cutting wheel

Part No#	Size	Cuts
REEDT10PIPECUTTER	1/8"-1"	Copper
REEDT15PIPECUTTER	3/16"-1-1/4"	Copper
REEDT20PIPECUTTER	5/8"-2-1/8"	Copper

Reed Quick Release Tubing Cutter



- . Easy and fast quick release design
- . Easy to change cutter wheel
- . Includes copper cutting wheel

Part No#	Size	Cuts
REEDTC1QPIPECUTTER	1/8"-1-5/16"	Copper
REEDTC1.6QPIPECUTTER	1/4"-15/8"	Copper
REEDTC2QPIPECUTTER	1/4"-2-5/8"	Copper
REEDTC3QPIPECUTTER	3/8"-3-1/2"	Copper

Reed Replacement Cutting Wheels



- . Replacement copper cutting wheels
- . Works on most Reed copper tubing cutters

Part No#	Type	Cuts
REEDTHINWHEEL	Thin	Copper
REEDTHICKWHEEL	Thick	Copper

HOLESAWS/HARDWARE

Lenox Hole Saw Arbor Bits



- . Arbor bits for Lenox hole saws
- . Includes pilot bit

Part No#	Lenox Part#	Type
LEN2L	2L	Wood/Metal
LEN5L	5L	Wood/Metal
LEN6L	6L	Wood/Metal

Lenox Bi-Metal Hole Saws



- . Sharp teeth for wood and metal cutting

Part No#	Size	Arbor Size
LEN5/8HOLES AW	5/8"	5L
LEN3/4HOLES AW	3/4"	5L
LEN7/8HOLES AW	7/8"	5L
LEN1HOLES AW	1"	5L
LEN11/8HOLES AW	1-1/8"	5L
LEN11/4HOLES AW	1-1/4"	5L
LEN13/8HOLES AW	1-3/8"	2L, 6L
LEN11/2HOLES AW	1-1/2"	2L, 6L
LEN19/16HOLES AW	1-9/16"	2L, 6L
LEN15/8HOLES AW	1-5/8"	2L, 6L
LEN13/4HOLES AW	1-3/4"	2L, 6L
LEN17/8HOLES AW	1-7/8"	2L, 6L
LEN2HOLES AW	2"	2L, 6L
LEN21/8HOLES AW	2-1/8"	2L, 6L
LEN21/4HOLES AW	2-1/4"	2L, 6L
LEN21/2HOLES AW	2-1/2"	2L, 6L
LEN25/8HOLES AW	2-5/8"	2L, 6L
LEN23/4HOLES AW	2-3/4"	2L, 6L
LEN3HOLES AW	3"	2L, 6L
LEN31/8HOLES AW	3-1/8"	2L, 6L
LEN31/4HOLES AW	3-1/4"	2L, 6L
LEN31/2HOLES AW	3-1/2"	2L, 6L
LEN35/8HOLES AW	3-5/8"	2L, 6L
LEN4HOLES AW	4"	2L, 6L
LEN41/8HOLES AW	4-1/8"	2L, 6L
LEN41/2HOLES AW	4-1/2"	2L, 6L
LEN43/4HOLES AW	4-3/4"	2L, 6L
LEN5HOLES AW	5"	2L, 6L
LEN6HOLES AW	6"	2L, 6L

Lenox 10PC Plumbers Hole Saw Kit



- . Kit includes 10 total pieces
- . Sizes: 3/4", 7/8", 1-1/8", 1-1/2", 1-3/4", 2-1/4"
- . Arbors includes standard 2L and 5L

Part No#	Lenox Part#	Type
LEN600PHOLESAWKIT	30808600P	Hole Saw Kit

Lenox Vari-Bit Step Drill Bit



- . Drills perfectly round holes
- . Sizes: 7/8", 1-1/8", 1-7/32", 1-1/4", 1-3/8"

Part No#	Lenox Part#	Type
LENVARIBIT	30912VB12	Drill Bit

Lenox Bi-Metal Self Feed Bits



- . Steel cutting edge easily cuts through nail-embedded wood
- . Extra long shank

Part No#	Size	Type
LEN1LEADERBIT	1"	Wood
LEN11/8LEADERBIT	1-1/8"	Wood
LEN11/4LEADERBIT	1-1/4"	Wood
LEN13/8LEADERBIT	1-3/8"	Wood
LEN11/2LEADERBIT	1-1/2"	Wood
LEN13/4LEADERBIT	1-3/4"	Wood
LEN2LEADERBIT	2"	Wood
LEN21/8LEADERBIT	2-1/8"	Wood
LEN21/4LEADERBIT	2-1/4"	Wood
LEN29/16LEADERBIT	2-9/16"	Wood
LEN35/8LEADERBIT	3-5/8"	Wood

Pilot Drill Bits



- . Pilot drill bit for hole saw



Part No#	Size	Length
LEN56PDPILOTBIT	1/4"	3"
LEN4321PILOTBIT	1/4"	4"
LEN3/8PADEBIT	3/8"	Spade Bit

DRILL BITS

Phillips Drill Bit



. 1/4" Phillips drill bit

Part No#	Size	Sell Qty
EMCPHILLIPSBIT	1/4" x 2"	Each

Magnetic Nut Driver Drill Bit



. Magnetic nut driver drill bit

Part No#	Size	Sell Qty
EMCMAGDRILLBIT1/4	1/4"	Each
EMCMAGDRILLBIT5/16	5/16"	Each

Drill Bits For Masonry



. Drill bits for masonry

Part No#	Size	Type
EMCMB3/16x4	3/16" x 4"	Masonry
EMCMB3/16x6	3/16" x 6"	Masonry
EMCMB1/4X4	1/4" x 4"	Masonry
EMCMB1/4X6	1/4" x 6"	Masonry
EMCMB3/8X4	3/8" x 4"	Masonry
EMCMB3/8X6	3/8" x 6"	Masonry
EMCMB1/2x6	1/2" x 6"	Masonry

Masonry Bit For Concrete Screws



. Replacement masonry bit for Tapcon style screws

Part No#	Size	Type
EMCTANGBIT3/16	3/16"	Masonry

Drill Bits For Wood & Metal



. Drill bits for wood and metal

Part No#	Size	Type
EMCDB1/16	1/16"	Wood/Metal
EMCDB5/64	5/64"	Wood/Metal
EMCDB3/32	3/32"	Wood/Metal
EMCDB7/64	7/64"	Wood/Metal
EMCDB1/8	1/8"	Wood/Metal
EMCDB9/64	9/64"	Wood/Metal
EMCDB5/32	5/32"	Wood/Metal
EMCDB11/64	11/64"	Wood/Metal
EMCDB3/16	3/16"	Wood/Metal
EMCDB13/64	13/64"	Wood/Metal
EMCDB7/32	7/32"	Wood/Metal
EMCDB15/64	15/64"	Wood/Metal
EMCDB1/4	1/4"	Wood/Metal
EMCDB17/64	17/64"	Wood/Metal
EMCDB9/32	9/32"	Wood/Metal
EMCDB19/64	19/64"	Wood/Metal
EMCDB5/16	5/16"	Wood/Metal
EMCDB21/64	21/64"	Wood/Metal
EMCDB11/32	11/32"	Wood/Metal
EMCDB11/32	23/64"	Wood/Metal
EMCDB3/8	3/8"	Wood/Metal
EMCDB25/64	25/64"	Wood/Metal
EMCDB13/32	13/32"	Wood/Metal
EMCDB27/64	27/64"	Wood/Metal
EMCDB7/16	7/16"	Wood/Metal
EMCDB29/64	29/64"	Wood/Metal
EMCDB15/32	15/32"	Wood/Metal
EMCDB31/64	31/64"	Wood/Metal
EMCDB1/2	1/2"	Wood/Metal

Lenox Hole Saw Extensions



. Extension arbors for Lenox hole saws

Part No#	Size	Type
LEN51/2EXTARBOR	5-1/2"	Extension
LEN12EXTARBOR	12"	Extension
LEN18EXTARBOR	18"	Extension

SAWZALL BLADES

Lenox General Purpose Sawzall Blades

. General purpose works for wood and metal



Part No#	Description	TPI
LEN676RC	6" Wood & Metal	6
LEN656R	6" Wood & Metal	6
LEN610R	6" Wood & Metal	10
LEN614R	6" Metal	14
LEN618R	6" Metal	18
LEN624R	6" Metal	24
LEN818R	8" Metal	18
LEN810R	8" Wood & Metal	10
LEN956R	9" Wood & Metal	6
LEN156R	12" Wood & Metal	6
LEN110R	12" Wood & Metal	10/14

Lenox Carbide/Cast Iron Sawzall Blades

. Heavy duty blades for steel piping



Part No#	Description	TPI
LEN800RG	8" Carbide	---
LEN800RDG	8" Cast Iron	---
LEN9108RCT	9" Cast Iron	---



TORCHES & SOLDERING ACCESSORIES

Turbo Torch STK-1 Torch Head



- . Skinny tip design
- . 360 degree swivel tip

TURBOTORCH

Part No#	Turbo Torch Part#	Type
TURSTK1	STK-1	Torch Head

Turbo Torch STK-9 Torch Head



- . Mapp soft solders from 1/4" - 3-1/2"
- . 360 degree swivel tip

TURBOTORCH

Part No#	Turbo Torch Part#	Type
TURSTK9	STK-9	Torch Head

Turbo Torch STK-99 Torch Head



- . Self igniting style head

TURBOTORCH

Part No#	Turbo Torch Part#	Type
TURSTK99	STK-99	Torch Head

Turbo Torch TX-504 Torch Head



- . Self igniting style head
- . Extreme series generates more heat

TURBOTORCH

Part No#	Turbo Torch Part#	Type
TURTX504	TX-504	Torch Head

Turbo Torch STK-11 Torch Head



- . Dual head design

TURBOTORCH

Part No#	Turbo Torch Part#	Type
TURSTK11	STK-11	Torch Head

Lead Free Solder



- . 95.6% Tin
- . 4% Copper
- . 0.4% Silver

Part No#	Size	Type
SIL100SOLDER	1 LB	Lead Free

Mapp Gas Cylinder



- . Flame temperature in air: 3,730 °F.
- . Burns hotter than standard propane

Part No#	Size	Type
EMCMAPPGAS	14.1oz	Mapp Gas

Propane Cylinder



- . Flame temperature in air: 3,600 °F.

Part No#	Size	Type
EMCPROPANE	14.1oz	Propane

Copper Brazing Rod



- . 92.9% Copper
- . 7.1% Phosphate

Part No#	Size	Type
JONSILVERSOLDERSTICK	1 LB	Solder Stick

Flame Protector

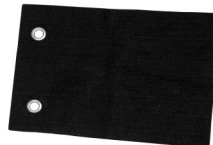

- . Specialty blanket protects walls from sparks and flames from a soldering torch

Part No#	Size	Type
OATFLAMEGUARD	9" x 12"	Flame Guard

Striker Tool



- . Easy to use
- . Replacement striker flints also available

Part No#	Description	Sell Qty
EMCSTRIKER	Striker Tool	Each
EMCSTRIKERFLINT	Replacement Striker Flints	5 Pack

SOLDERING ACCESSORIES

Acid Brush



. Smooth bristles apply soldering paste to copper pipe before soldering a joint

Part No#	Size	Type
EMCACIDBRUSH	AB24	Flux Brush

Copper Fitting Cleaning Brush



. Thick bristles clean copper pipe before soldering a joint

Part No#	Size	Type
EMCCOPBRUSH1/4	1/4"	Plastic
EMCCOPBRUSH1/2	1/2"	Plastic
EMCCOPBRUSH3/4	3/4"	Plastic
EMCCOPBRUSH1	1"	Plastic
EMCCOPBRUSH11/4	1-1/4"	Plastic
EMCCOPBRUSH11/2	1-1/2"	Plastic
EMCCOPBRUSH2	2"	Plastic

Combination Copper Fitting Cleaning Brush



. 4 in 1 style copper cleaning brush
. Includes 4 different cleaning brushes

Part No#	Description	Size
WALCOMBOFTGBRUSH	4 in 1 Cleaning Brush	1/2" & 3/4"

Copper Flaring Tool



. Creates smooth flare
. Works on sizes: 3/16", 1/4", 5/16", 3/8", 1/2" OD, 5/8"

Part No#	Size	Type
PASFLARETOOL	See Listing Above	Flare Tool

Hammer Flare Tool



. Hammer flare tool for soft copper tubing

Part No#	Size	Type
PASFLARETOOL3/4	3/4"	Steel
PASFLARETOOL1	1"	Steel
REED11/2FLARETOOL	1-1/2"	Steel
REED2FLARETOOL	2"	Steel

Copper Swedge Tool



. Can be used on aluminum, soft copper and any other soft tubing
. Use on 1/4", 5/16", 3/8" 1/2", & 5/8" tubing
. Heat-treated carbon steel

Part No#	Description	Type
WALSWEDGETOOL	Copper Swedge Tool	Steel

Oatey #5 Soldering Paste



. 100% lead free soldering paste
. Effective on all metals except stainless steel and aluminum

Part No#	Size	Type
OAT#5PASTE8oz	8oz	Soldering Paste
OAT#5PASTE16oz	16oz	Soldering Paste

Hercules Climate Smooth Soldering Paste



. Works great in temperatures all year long
. 100% lead free soldering paste
. 9oz can includes brush

Part No#	Size	Type
HERCLIMATEFLUX9oz	9oz	Soldering Paste
HERCLIMATEFLUX16oz	16oz	Soldering Paste

Original Sand Cloth



. Original sand cloth material
. Not suitable with water

Part No#	Size	Type
EMCSANDCLOTH	10YD	Sand Cloth

Open Mesh Sand Cloth



. Open mesh sand cloth material
. Can be used with water

Part No#	Size	Type
EMCOPENMESH	10YD	Open Mesh

HAND TOOLS

EMC 6 In 1 Screwdriver



. 6 inter-changeable heads

Part No#	Description	Type
EMC6IN1SCREWDRIVER	6 in 1 Screwdriver	Hand Tool

Nut Driver



. Heat treated construction

Part No#	Size	Type
EMCNUTDRIVER1/4	1/4"	Nut Driver
EMCNUTDRIVERS/16	5/16"	Nut Driver

Reed Deburring Tool



. Hard steel blade
. Easily fits in pocket

Part No#	Reed Part#	Type
REEDDEBODEBURRING	04434	Deburring Tool

No Hub Torque Wrench



. 5/16 socket size
. Built in reversing lever
. Ratchets one way

Part No#	Description	Size
PASN/HTORQUEWRENCH	No Hub Torque Wrench	5/16

Tub & Shower Valve Wrench Set



. Sizes include: 21/32" x 27/32", 29/32" x 32/32", 1-1/32" x 1-3/32", 1-11/32" x 1-7/16", 1-5/32" x 1-9/32"

Part No#	Description	Type
EMCSHOWERSOCKETSET	Tub & Shower Wrench Set	Steel

Utility Knife



. Heavy duty utility knife

Part No#	Description	Type
EMCKNIFEORANGE	Utility Knife	Metal
EMCKNIFEBLADESSPK	Replacement Blades	5-Pack Blades

Lenox Gold Knife Blades



. Lasts longer than standard utility blades
. Fits all standard utility knives

Part No#	Lenox Part#	Type
LENGOLD5PKBLADE	20350GOLD5C	5 Pack
LENGOLD50PKBLADE	20351GOLD50D	50 Pack

Thermometers



. Available in standard and digital



Part No#	Description	Type
EMCPOCKETTHERMOMET	Pocket Thermometer	Plastic
WALPOCKETRHERM	Digital Thermometer	Plastic

Flash Light



. Comfort grips

Part No#	Size	Type
EMCFLASHLIGHT	2618ML	Flashlight

Batteries



. Replacement batteries

Part No#	Type	Sell Qty
EMCBATTERYAAA	AAA	Each
EMCBATTERYAA	AA	Each
EMCBATTERYC	C	Each
EMCBATTERYD	D	Each

HAND TOOLS

4-Way Stem Key



- . Plated steel
- . For valve, faucet and sillcock sizes 1/4", 9/32", 5/16" and 11/32"

Part No#	Description	Type
EMC4WAYSTEMKEY	4-Way Stem Key	Steel

Folding Hex Key Set



- . Small set sizes: .050", 1-1/6", 5/64", 3/32", 7/64", 1/8", 9/64", 3/16"
- . Large set sizes: 3/16", 7/32", 1/4", 5/16", 3/8"

Part No#	Size	Type
EMCALLENSETSMALL	See Listing Above	Small Key Set
EMCALLENSETLARGE	See Listing Above	Large Key Set

Closet Seat Nut Wrench



- . Removes most ballcock nuts

Part No#	Description	Type
PASVANHOOTEEWRENCH	Closet Nut Wrench	Wrench

Basin Buddy Faucet Nut Wrench



- . Loosens most faucet nuts
- . To be used with a 3/8" socket

Part No#	Description	Type
WALBASINBUDDY	Faucet Nut Wrench	Wrench

Basin Wrench



- . Spring loaded jaws for one hand ratcheting
- . Extends for hard to reach places

Part No#	Size	Type
REEDBASINWRENCH	3/8" - 1-1/4"	Basin Wrench

Radiator Spud Wrench



- . Plated malleable iron construction
- . For use as a spud key and wrench

Part No#	Description	Type
PASRADIATORWRENCH	Radiator Spud Wrench	Iron

4-Way P.O Plug Wrench



- . For installing or removing tub drains, basket strainers and P.O plugs

Part No#	Description	Type
PAS4WAYPLUGWRENCH	4-Way P.O Plug Wrench	Steel

6-Way Cleanout Plug Wrench



- . Extra strong construction
- . 4 head sizes for square plugs
- . 2 head sizes for slotted plugs

Part No#	Description	Type
PASC/SPLUGWRENCH	6-Way Wrench	Steel

Faucet Seat Wrench



- . Tapered design allows for use on all sizes and types of seats

Part No#	Description	Type
PASFAUCETSEATWRENCH	Faucet Seat Wrench	Angle

Universal Drain Wrench



- . 6" long
- . Installs and removes tub drains and closet spuds
- . Prevents damage to a decorative finish
- . Use crescent wrench or screwdriver to turn tool

Part No#	Description	Type
PASDUMBBELLWRENCH	Universal Drain Wrench	Steel

Faucet Handle Puller



- . Plated steel
- . Removes faucet and valve handles

Part No#	Description	Type
PASHANDLEPULLER	Faucet Handle Puller	Steel

Moen Cartridge Puller



- . Works on Moen 1200, 1222 & 1225 cartridges

Part No#	Description	Type
WALMOENCARTTOOL	Moen Cartridge Tool	Tool

Pasco Basket Strainer Wrench



- . Fits 3-3/8" basket strainer nut
- . 5-1/2" length

Part No#	Size	Type
PASBASKETSTRWRENCH	3-3/8"	Plastic

PVC Cable Saw



- . Used for cutting PVC pipe in tight spaces
- . Faster and easier than hacksaws in low clearance areas
- . 36" length

Part No#	Description	Length
PASCABLESAW36	PVC Cable Saw	36"

Inside Pipe Cutter



- . Cuts 2" and larger plastic piping
- . Includes fiber cutting wheel

Part No#	Description	Type
WALINSIDEPIPECUTTER	Inside Pipe Cutter	Steel
WALINSIDECUTTERWHEEL	Replacement Wheels	2-Pack Wheels

E-Z Shear Inside Pipe Cutter



- . Cuts PVC piping
- . High speed steel blade

Part No#	Description	Type
PASINSIDEEZSHEARTOOL	E-Z Inside Pipe Cutter	Steel
PASINSIDECUTTEREZSHE	Replacement Wheels	2-Pack Wheels

Socket Saver



- . Removes PVC piping from a hub
- . Cuts PVC piping below a slab

Part No#	Size	Type
WAL11/2SOCKETSAVER	1-1/2"	Steel
WAL2SOCKETSAVER	2"	Steel
WAL3SOCKETSAVER	3"	Steel
WAL4SOCKETSAVER	4"	Steel

Lenox High Tension Hacksaw



- . For high tension metal cutting
- . Rubber grip handles

Part No#	Lenox Part#	TPI
LENHACKSAWHT-50	12132-HT-50	—
LENHACKSAWBLADE218	218HE	18
LENHACKSAWBLADE224	224HE	24
LENHACKSAWBLADE232	232HE	32

Lenox Handsaw



- . To cut plastic PVC piping

Part No#	Lenox Part#	Description
LENHANDSAW18	20980HSF18	Tool Only
LENHANDSAWBLADE12	20982HSB12	12" BLADE ONLY
LENHANDSAWBLADE18	20981HSB18	18" BLADE ONLY

EMC Mini Hacksaw



- . Works in compact spaces
- . EMC Manufacturing

Part No#	Size	Type
EMCMINIHAWSAW	1/4" x 6"	Tool With Blade
EMCMINISAWBLADE	1/4" x 6"	Replacement Blades

Jones Mini Hacksaw



- . Works in compact spaces
- . Jones Stephens

Part No#	Size	Type
JONMINIHAWSAW	1/4" x 6"	Tool With Blade



- . Lenox close quarter style hacksaw blades
- . Works with Jones Stephens mini hacksaw

Part No#	Size	Type
LENCLOSEQTRBLADE	1/4" x 6"	Replacement Blades

HAND TOOLS

Sioux Chief PVC Saw



- . 20" blade
- . Steel blade

Part No#	Description	Size
SIOPVCHANDSAW	PVC Handsaw	20"

Pull Plastic Pipe Saw



- . For smooth, fast and accurate cutting
- . Cuts plastic pipe and wood

Part No#	Description	Size
JONEZSAW	E-Z Stroke Pipe Saw	12"

Lenox Tri-Fold Folding Saw



- . Includes folding saw with 2 blades
- . Comfort grip handle
- . Works on drywall, plaster, wood & more

Part No#	Lenox Part#	Type
LENJABSAW	20997TFHS618636	Folding Saw

Claw Hammer



- . Rubber grip handle
- . Heat treated steel construction

Part No#	Size	Type
EMCLAWHAMMER	16oz	Claw Hammer

Ripping Bar



- . 90 degree bar fits easily in tight quarters
- . Heat treated steel

Part No#	Size	Type
EMCRIPPINGBAR17"	17"	Ripping Bar

Cold Chisel



- . High carbon steel construction

Part No#	Size	Type
EMCCOLDCHISEL	3/4" x 12"	Cold Chisel

Hammer Drive Pin Tool



- . Designed to drive hammer pins through wood, light steel and concrete

Part No#	EMC Part#	Type
EMCHAMMERPIN TOOL	EHD50	Hammer Tool

Copper Swedge Tool



- . Can be used on aluminum, soft copper and any other soft tubing
- . Use on 1/4", 5/16", 3/8" 1/2", & 5/8" tubing
- . Heat-treated carbon steel

Part No#	Description	Type
WALSWEDGETOOL	Copper Swedge Tool	Steel

Copper Flaring Tool



- . Creates smooth flare
- . Works on sizes: 3/16", 1/4", 5/16", 3/8", 1/2" OD, 5/8"

Part No#	Size	Type
PASFLARETOOL	See Listing Above	Flare Tool

Hammer Flare Tool



- . Hammer flare tool for soft copper tubing

Part No#	Size	Type
PASFLARETOOL3/4	3/4"	Steel
PASFLARETOOL1	1"	Steel
REED11/2FLARETOOL	1-1/2"	Steel
REED2FLARETOOL	2"	Steel

HAND TOOLS

Scratch Awl



. Heat treated metal

Part No#	Description	Type
EMCSCRATCHAWL	Scratch Awl	Tool

Reed Complete Die-Head Kit



. Kit includes 3 die-heads and handle set

Part No#	Reed Part#	Size
REEDRATCHETKIT1/2-1	05204	1/2" - 1"

Pipe Taps & Wrench



. Steel construction

Part No#	Size	Type
EMCTAP1/4x20	1/4" -20	Steel
EMCTHANDLETAP	—	Steel
PASPIPETAP1/2	1/2" NPT	Steel
PASPIPETAP3/4	3/4" NPT	Steel

Metal Stud Punch Tool



- . Punches holes in metal studs up to 1-11/32"
- . Reaches 3-1/2" deep
- . Rubber grips for easy leverage

Part No#	Pipe Tapes Part#	Type
PIPSTUDPUNCH	ET-5	Stud Punch Tool

Caulk Gun



. "Drop-In" half barrel style

Part No#	Description	Type
PASCAULKGUN	Caulk Gun	Metal

Torpedo Level



. Heavy duty

Part No#	Description	Size
EMCTORPEDOLEVEL	Torpedo Level	9"

24" Level



. Fiberglass material

Part No#	Description	Size
EMCLEVEL24	24" Level	24"

Tape Measure



- . Ridgid tape
- . Easy to read numbers

Part No#	Description	Size
EMCTAPEMEASURE25	25' Tape Measure	25'

Adjustable Wrench



. Metal adjustable wrench

Part No#	Size	Type
EMCADJWRENCH4	4"	Metal
EMCADJWRENCH6	6"	Metal
EMCADJWRENCH8	8"	Metal
EMCADJWRENCH10	10"	Metal

Commercial Twist Drain Wrench



- . Works with any 3-1/2" commercial drain
- . Heavy duty

Part No#	Description	Type
PASTWISTLEVERWRENCH	Twist Lever Drain Wrench	Metal

Tailpiece Tool For Flushometers



- . Fits Sloan, Zurn and Delaney flushometers
- . Used to adjust or remove tailpieces
- . May also be called the "Spud Buddy"

Part No#	Walrich Part#	Type
WALSLOANWRENCH	1851000	Tool

Sloan Flushmate Cartridge Wrench



- . Universal to fit all flushmate cartridges
- . Can also be used to tighten or remove supply nut on tank
- . Can also be used to tighten or remove large cylinder nut

Part No#	Sloan Part#	Type
SLOST100100	ST100100	Tool

Lead Pouring Ladle



- . 4" lead pouring ladle
- . Steel construction

Part No#	Size	Type
WAL4LEADLADLE	4"	Steel

Lead Caulking Tools



- . Lead tools for packing oakum at lead joints

Part No#	Size	Type
WALINSIDCAULKTOOL	5/8" x 7"	Inside Lead Tool
WALOUTSIDCAULKTOOL	5/8" x 7"	Outside Lead Tool

Wrench For House Filter Housing



- . Installation and removal wrench for Watts filter housing

Part No#	Description	Type
WATFTRWRENCH	Filter Housing Tool	Plastic

Poly Tubing Cutter



- . Includes 2-1/4 metal blade
- . Quickly cuts PEX, PVC and other poly tubing
- . Will cut up to 1-1/8 OD or smaller

Part No#	Size	Type
SIOPOLYTUBECUTTER	1-1/8" OD	Tool

PEX Cinch Clamp Tool



- . Long, easy to grip handles
- . Quick release only when ring is fully crimped
- . Works on stainless steel crimp rings only

Part No#	Size	Type
PEXCRIMPPTOOLREG	3/8", 1/2", 3/4", 1"	Tool

Ratcheting PEX Cinch Clamp Tool



- . Unique design for tight spaces
- . Includes light that will light up when crimp is complete
- . Works on stainless steel crimp rings only

Part No#	Size	Type
PEXCRIMPPTOOLRATCHET	3/8", 1/2", 3/4", 1"	Tool

Copper Crimp Ring Kit



- . Long, easy to grip handles
- . Includes convenient plastic carrying case
- . Jaws change with hex wrench
- . Works on copper crimp rings only

Part No#	Size	Type
PEXRINGCRIMPPTOOL	1/2", 3/4", 1"	Tool

HAND TOOLS

Channellock Pliers



- . Strong and durable construction
- . Easy grip handles
- . MADE IN THE USA



Part No#	Description	Channellock Part#
EMC426G	6.5" Straight Jaw T & G	426
EMC317G	8" Side Cut Long Nose	317
EMC410G	9.5" Nutbuster T & G	410
EMC415G	10" Smooth Jaw T & G	415
EMC420G	9.5" Straight Jaw T & G	420
EMC430G	10" Speedgrip T & G	430
EMC440G	12" Speedgrip T & G	440
EMC460G	16.5" Straight Jaw T & G	460

Reed Smooth Jaw Spud Wrench



- . Ductile iron construction
- . Expands to a 2-5/8" opening
- . Smooth jaws will not damage finishes

Part No#	Reed Part#	Size
REEDR-SPUD	02112	12"

Reed Smooth Jaw Offset Hex Spud Wrench



- . Ductile iron construction
- . Offset style Hex wrench
- . Smooth jaws will not damage finishes

Part No#	Reed Part#	Size
REEDR-110HEXWRENCH	02111	10"

Reed Pipe Wrench



- . Aluminum construction
- . Heavy duty



Part No#	Reed Part#	Size
REED14OFFSETWRENCH	ARWO-14	14" Offset
REED18OFFSETWRENCH	ARWO-18	18" Offset
REED14PIPEWRENCH	ARW-14	14"
REED18PIPEWRENCH	ARW-18	18"
REED24PIPEWRENCH	ARW-24	24"

Reed Ratcheting Soil Pipe Cutter



- . Works on pipe from 1-1/2" - 6"
- . Chain pressure snaps the pipe

Part No#	Reed Part#	Size (Length)
REEDSC49-6SOILCUTTER	SC49-6	26"

Reed Single Stroke Soil Pipe Cutter



- . Works on pipe from 1-1/2" - 6"
- . Chain pressure snaps the pipe

Part No#	Reed Part#	Size (Length)
REEDSC59-6SOILCUTTER	SC59-6	43"

**Madison Heights
Plumbing & Heating Supply**

SECTION 11 -

DRAINS & CLEANOUTS

Shower Pan & Drains 211

Floor Drains 212-213

Cleanout Assemblies 214

SHOWER PAN & DRAINS

Pasco Vinyl Shower Pan Liner



. 40 mil



Part No#	Width	Roll Size
PASSPLINER4ROLL	48"	40'
PASSPLINER5ROLL	60"	40'
PASSPLINER6ROLL	72"	40'

. Shower pan also available cut to requested size. Price charged per square foot. All shower pan cut to size is non returnable.

Pasco Flush Dam Corner



. Use where a flat wall or stall backing board meets a dam at a 90° angle

Part No#	Pasco Part#	Type
PASDAMCORNERREG	3000	Rubber

Pasco Inside Dam Corner



. Use where a wide 90° top corner of a two dam stall or roman tub meet

Part No#	Pasco Part#	Type
PASINSIDEDAMCORNER	3003	Rubber

Pasco Other Dam Corner



. Most commonly used for deep tubs
. Prevents folded pan buildup in corners

Part No#	Pasco Part#	Type
PASOTHERDAMCORNER	3005	Rubber

Pasco Vinyl Shower Pan Cement



. Must be used to join Pasco brand shower pan material
. 24 hour total cure time
NOTE: PVC CEMENT WILL NOT WORK ON SHOWER PAN MATERIAL

Part No#	Pasco Part#	Size
PASSPEMENTPT	3008	16oz

Jones Stephens Shower Drain With Round Top



. For use with shower pan liner material
. Gray camouflage color design

Part No#	Size	Finish
JONSSSHOWERSTR	2"	Stainless Steel

Jones Stephens Shower Drain Round Tops Only



. Decorative round replacement tops for Jones Stephens shower pan drain
. Includes matching screws

Part No#	Jones Part#	Finish
JONNBTOPONLY	C60-89BN	Brushed Nickel
JONORBTOPONLY	C60-89RG	Oil Rubbed Bronze

Sioux Chief Shower Drain With Round Top



. Note: Chrome finished top is a heavy duty top
. For use with shower pan liner material
. Includes test plug for water test

Part No#	Size	Finish
SIOSSSHOWERSTR	2"	Stainless Steel
SIOHDCPSHOWERSTR	2"	Chrome

Sioux Chief Shower Drain With Square Top



. Note: Chrome finished top is a heavy duty top
. For use with shower pan liner material

Part No#	Size	Finish
SIOSQHDCPSHOWERSTR	2"	Chrome

Sioux Chief Shower Drain Square Tops Only



. Adapts a round Sioux chief strainer to a square top
. Includes matching screws

Part No#	Sioux Chief Part#	Finish
SIO821-2QAS	821-1QAS	Stainless Steel
SIO821-2QASN	821-QASN	Satin Nickel
SIO821-2QARB	821-2QARB	Oil Rubbed Bronze

Shower Stub-Out Test Plug



- . Threaded directly into a shower wing elbow
- . No thread tape required so it can be reused
- . 1/2" MPT

Part No#	Size	Type
PASSTUBOUTPLUG	1/2" MPT	Plastic

PVC General Purpose Shower Drain



- . Glues over 2" PVC DWV piping

Part No#	Size	Finish
SIO825-2P	2"	Stainless Steel

Shower Stall Drains With Gasket



- . Stainless steel top
- . Includes rubber no caulk gasket designed for shower stall bases

Part No#	Size	Body
SIO827-2B	2"	Brass
SIO828-2	2"	PVC

PVC Pipe Fit Style Floor Drain



- . Strainer directly glues into PVC DWV piping.

Part No#	Size	Finish
SIOPVCSTRAINER2	2"	Plastic
OAT3PIPEFITSTRSSTOP	3"	Stainless Steel
OAT4PIPEFITSTRSSTOP	4"	Stainless Steel

PVC General Purpose Floor Drain



- . General purpose solvent weld floor drain

Part No#	Size	Finish
SIO840-2P	3" x 2"	Stainless Steel

Sioux Chief Adjustable Floor Drain Assembly



- . Round nickel bronze top
- . Complete unit included base and top

Part No#	Size	Finish
SIO832-36PNR	3"	Nickel Bronze

Stainless Steel Gripper Style Floor Drain



- . Prongs slip right into PVC DWV piping

Part No#	Size	Fits
SIOGRIPPERSTRN2	2"	2" DWV
SIOGRIPPERSTRN3	3"	3" DWV
SIOGRIPPERSTRN4	4"	4" DWV

Sioux Chief Floor Drain Housing



- . Threaded port for optional trap primer
- . Extra threads for easy adjustment

Part No#	Sioux Chief Part#	Size
SIO842-82PT	842-82PT	2"
SIO842-83PT	842-83PT	3"

Sioux Chief Large Base For Shower Drain



- . For use with shower pan liner material
- . 3" PVC DWV drain size

Part No#	Sioux Chief Part#	Spud Size
SIO863HP33	863-HP33	3" FPT
SIO863HP34	863-HP34	4" FPT

Adjustable Floor Drain Tops Less Base



- . Threaded to be screwed into a PVC adapter or drain base
- . Heavy duty tops

Part No#	Size	Finish
SIO842-2LNR	2" Round	Nickel Bronze
SIO842-3LNR	3" Round	Nickel Bronze
SIO842-4LNR	4" Round	Nickel Bronze
SIO842-3LCR	3" Round	Chrome
SIO842-3LCQ	3" Square	Chrome

PVC Heavy Duty Top Floor Drain



- . Glues over 3" PVC DWV piping
- . Heavy duty nickel bronze top

Part No#	Size	Finish
SIO823-3PNR	3" Round	Nickel Bronze

FLOOR DRAINS/MISC DRAINS

Heavy Duty Cast Iron Floor Drain With Top



- . Heavy duty polished nickel bronze top
- . 3" No Hub connection
- . Includes base and top

Part No#	Zurn part#	Finish
ZURZN4153NH5B	ZN415-3NH-5B	Nickel Bronze

Sioux Chief Drain Funnel



- . Designed to receive drips to direct water to a floor drain

Part No#	Sioux Chief Part#	Finish
SMI3580	863-FN	Nickel Bronze

Sioux Chief Trap Primer



- . To be used to keep water running through a floor drain to prevent sewer gas odors from entering an area
- . Brass body

Part No#	Sioux Chief Part#	Size
SIOTRAPPRIMER1/2	695-01	1/2" FPT

Floor Drain Trap Seal



- . Replaces a trap primer in floor drains
- . Blocks sewer gases from backing up into working and living areas

Part No#	Size	Type
SURSS-2009	2"	Plastic
SURSS-3000	3"	Plastic
SURSS-4009	4"	Plastic

Floor Drain Flood Guard



- . Works like a check valve to seal off water from backing up
- . Float style

Part No#	Size	Type
EMCFLOODGUARD2	2"	Rubber
EMCFLOODGUARD3	3"	Rubber
EMCFLOODGUARD4	4"	Rubber

Medium Duty Drain With Tractor Grate



- . Cast iron body
- . Includes tractor grate

Part No#	Zurn Part#	Type
ZURZ551TG4NH	Z551-TG-4NH	Cast Iron

Sediment Bucket

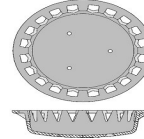

- . Sediment bucket for tractor grate style drain
- . Traps sediment from entering the drain

Part No#	Description	Type
SMI2271BUCKET	Sediment Bucket	Cast Iron

Brass Cow Tongue Downspout Drain



- . Includes mounting bracket
- . Standard FPT connection

Part No#	Size	Finish
SMI17703	3"	Brass
SMI17704	4"	Brass
SMI17706	6"	Brass

CLEANOUTS

PVC Flush Cleanout Assembly



- . Glues directly into PVC piping
- . Includes threaded 1/4" tapping to accept cleanout screw

Part No#	Size	Type
SIOTOMCAP3	3"	SPG
SIOTOMCAP4	4"	SPG

Sioux Chief Round Cleanout Top Only



- . Brass cleanout top spud only
- . To be used with PVC female adapter or drain base

Part No#	Size	Type
SIO852-3LNR	3" MPT	Brass
SIO852-4LNR	4" MPT	Brass

Sioux Chief Adjustable Cleanout Assembly



- . Round nickel bronze top
- . Complete unit included base and top

Part No#	Size	Finish
SIO834-4PNR	4"	Nickel Bronze

Heavy Duty Cast Iron Cleanout



- . Includes housing and cover plate

Part No#	Size	Finish
SIOCICOHOUSING4	4"	Cast iron
SIOCICOHOUSING6	6"	Cast Iron

Zurn Heavy Duty Cast Iron Cleanout



- . Polished nickel bronze top
- . Includes body and spud

Part No#	Zurn Part#	Finish
ZURZ14004NH	Z1400-4NH	Nickel Bronze

Madison Heights Plumbing & Heating Supply

SECTION 12 -

CLEANING & CEMENTS

Drain Cleaning & Concrete	216
PVC Cements & Primers	217
Sealants & Tape	218-219
Personal Care & Cleaning	220
Truck Accessories	221

General SuperVee Drain Tool



- . For sinks, tubs and laundry drains
- . Quick cable change cartridge
- . Made In The U.S.A

Part No#	General Part#	Type
GENSVAWC	SV-A-WC	Drain Tool

General Drain Cable



- . Flexicore cable for SuperVee drain tool
- . Includes basin head

Part No#	General Part#	Size
GEN25HE1	25HE1	1/4" x 25'

General Closet Auger



- . 3' flexicore steel cable
- . Vinyl grip handle

Part No#	General Part#	Length
GEN3FL	3FL	3'

General Closet Auger With Down Head



- . 3' flexicore steel cable
- . Vinyl grip handle
- . The down head makes it easier for the snake to follow bowl contours

Part No#	General Part#	Length
GEN3FL-DH	3FL-DH	3'

Sizzle Urinal Drain Opener



- . Quickly dissolves urinary salts from urinals
- . Can be used with iron, copper, brass, steel, bronze and lead fixtures
- . **FOR PROFESSIONAL USE ONLY!**

Part No#	Brand	Size
HERSIZZLE	Hercules	32oz

Clobber Drain Opener



- . Fast drain cleaner
- . Works on hair and paper products

Part No#	Brand	Size
HERCLOBQT	Hercules	32oz
HERCLOB1/2GAL	Hercules	64oz

Root Destroyer Compound



- . Formula designed to clear root filled sewer lines
- . Non-acidic

Part No#	Size	Type
HERROOTOUT	2 lbs.	Root Destroyer

Drain Banger Drain Chrystals



- . Destroys grease, hair and oils that plug drains within 60 seconds

Part No#	Size	Type
MILDRAINCRYSTALS	1 LB	Drain Cleaner

Sand Topping Mixture



- . Repairs and fills concrete less than 2" thickness
- . Hardens when water is added

Part No#	Size	Type
QUI60#CEMENT	60 lbs.	Sand Topping Mix

Water Stopping Cement



- . Forms a permanent masonry seal
- . Stops flowing water immediately
- . Set time: 3-5 minutes

Part No#	Size	Type
EMCWETPLUG10#	10 lbs.	Wet Plug Cement

Furnace Cement



- . Shrink and crack proof
- . Fireproof when cured

Part No#	Size	Type
RECFURNACECEMENT6#	6 lbs.	Furnace Cement

Medium Clear PVC Cement (Seasonal)



. Recommended for potable water, pressure pipe, & DWV.
 . Recommended temperature 40° F to 110° F.

Part No#	Size	Color
OATCEMENT8OZ	8oz	Clear
OATCEMENT16OZ	16oz	Clear
OATCEMENT32OZ	32oz	Clear

All Weather Cement (Seasonal)



. Recommended for potable water, pressure pipe, & DWV.
 . Recommended temperature -15° F to 110° F.

Part No#	Size	Color
OATA/WCEMENT16OZ	16oz	Clear
OATA/WCEMENT32OZ	32oz	Clear

Heavy Duty Clear Cement



. Recommended for potable water, pressure pipe, & DWV. Thick formula fills gaps in large diameter pipe.
 . Recommended temperature 40° F to 110° F.

Part No#	Size	Color
OATCEMENTGAL	128oz	Clear

Heavy Duty Gray Cement



. Recommended for potable water, pressure pipe, & DWV. Thick formula fills gaps in large diameter pipe.
 . Recommended temperature 40° F to 110° F.
 . Recommended for schedule 80 PVC piping.

Part No#	Size	Color
OATHDCEMENTGAL	32oz	Gray

One Step CPVC Cement



. Recommended for CPVC cold water systems or hot water systems up to 200° F.
 . Recommended temperature 0° F to 110° F.
 . Does not require the use of primer.

Part No#	Size	Color
OATCPVC1STEPCEMENT8	8oz	Yellow

All Purpose Cement



. Recommended for potable water, pressure pipe, CPVC & DWV.
 . Recommended temperature 40° F to 110° F.

Part No#	Size	Color
OATALLPURPOSE4OZ	4oz	Clear

Purple Primer



. Recommended for potable water, pressure pipe, CPVC & DWV.
 . Recommended temperature 40° F to 110° F.

Part No#	Size	Color
OATPRIMER8OZ	8oz	Purple
OATPRIMER16OZ	16oz	Purple
OATPRIMER32OZ	32oz	Purple
OATPRIMERGAL	128oz	Purple

Clear Primer



. Recommended for potable water, pressure pipe, CPVC & DWV.
 . Recommended temperature 40° F to 110° F.

Part No#	Size	Color
OATCLEARPRIMER16OZ	16oz	Clear
OATCLEARPRIMER32OZ	32oz	Clear

PVC Cement Daubers

. Daubers for PVC Cements



Part No#	Size	Type
OATQTDOBBER	16oz/32oz	Dauber
OATDOBBERGAL	128oz	Dauber
OATROLLAPPLICATOR	128oz	Roll Applicator

Pasco Vinyl Shower Pan Cement



. Must be used to join Pasco brand shower pan material
 . 24 hour total cure time
NOTE: PVC CEMENT WILL NOT WORK ON SHOWER PAN MATERIAL

Part No#	Pasco Part#	Size
PASSCEMENTPT	3008	16oz

SEALANTS & LUBRICANTS

Standard Plumbers Putty



- . Suitable for setting bowls, fixtures and a variety of other items
- . Creates a watertight seal

Part No#	Size	Type
HER1#PUTTY	16oz	Putty
HER5#PUTTY	128oz	Putty

Ultra Non Staining Plumbers Putty



- . Non oil formula will not stain any type of countertop
- . Creates a watertight seal

Part No#	Size	Type
HER1#ULTRAPUTTY	16oz	Putty

Siliconized Acrylic Caulk



- . Fast drying , water based acrylic caulk
- . Easy to clean

Part No#	Size	Color
OSITUBECLARCAULK	5.5oz	Clear
OSITUBEWHITECAULK	5.5oz	White
HARTUBEBOECAULK	5.5oz	Bone

100% Silicone Tube



- . Creates a flexible, durable weather resistant seal
- . 100% RTV
- . Convenient squeeze tube

Part No#	Size	Color
HAR2.8CLEAR SILICONE	2.8oz	Clear
HAR2.8WHITESILICONE	2.8oz	White

100% Silicone Caulk Gun Cartridge



- . Creates a flexible, durable weather resistant seal
- . 100% RTV
- . Caulk gun style cartridge

Part No#	Size	Color
HARCARTCLEAR SILICONE	10.3oz	Clear
HARCARTWHITESILICONE	10.3oz	White

Tub & Tile Silicone Caulk Cartridge



- . Fast drying , water based acrylic caulk
- . Easy to clean
- . Caulk gun style cartridge

Part No#	Size	Color
HARCARTWHITECAULK	10.3oz	White

Fire Stopping Products



- . 100% silicone fire barrier caulk
- . UL Classified fire foam rating



Part No#	Size	Type
EMCFIRESTOP	10.3oz	Fire Caulk
WALFIREFOAM	12oz	Fire Foam

Epoxy Putty Tube



- . Mending compound to repair leaks and patch holes
- . 20 min. set time

Part No#	Size	Type
OATEPOXYPUTTY	4oz	Epoxy Stick

Faucet Grease



- . Waterproof
- . Resists high temperatures



Part No#	Size	Type
HARFAUCETGREASE	1oz	Tube
WALFAUCETGREASE	1.7oz	Can

WD-40 Lubricant



- . Cleans, lubricates, and protects against rust
- . Penetrates stuck metal parts
- . 11oz can with convenient spray nozzle

Part No#	Size	Color
EMCWD40	11oz	Clear

Orange Marking Paint Spray Can



- . Fast drying marking paint

Part No#	Size	Color
EMCORANGEPAINT	17oz	Orange

Jomar White Pipe Dope



- . Slow drying, soft setting PTFE sealant
- . Typically used for water piping
- . Surface temperature rating: -50°F to 400°F.

Part No#	Size	Color
JOMWHITE1/2PT	8oz	White
JOMWHITE1PT	16oz	White

Jomar Green Pipe Dope



- . Slow drying, soft setting non-hardening sealant
- . Typically used for gas piping
- . Surface temperature rating: -50°F to 400°F.

Part No#	Size	Color
JOMGREEN1/2PT	8oz	White
JOMGREEN1PT	16oz	White

Jomar WOG Hard Set Pipe Dope



- . Fast drying, hard setting thread sealant
- . Surface temperature rating: -50°F to 400°F.

Part No#	Size	Color
JOMWOG1PT	16oz	Red

True Blu Pipe Dope



- . For use on potable water
- . Contains PTFE
- . Surface temperature rating: 20°F to 140°F.

Part No#	Size	Color
RECTRBLUE8oz	8oz	Blue
RECTRBLUE16oz	16oz	Blue

Better Bubble Leak Detector



- . Fast acting thick formula creates long lasting bubbles
- . Surface temperature rating: 20°F to 250°F.

Part No#	Size	Color
RECBETTERBUBBLE	32oz	Blue

Blue Monster Cold Spray



- . Protects components from heat during soldering

Part No#	Size	Color
MILARTICGEL	32oz	Blue

White PTFE Teflon Tape

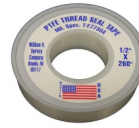

- . Standard white PTFE teflon tape
- . Can be used on water and gas pipe

Part No#	Size	Color
HARTEFTAPE1/2	1/2" x 260"	White
HARTEFTAPE3/4	3/4" x 260"	White
HARTEFTAPE1	1" x 260"	White

Blue Monster PTFE Teflon Tape



- . Blue monster brand PTFE Teflon tape
- . Can be used on water and gas pipe

Part No#	Size	Color
MIL1/2BLUEMONSTER	1/2" x 1429"	Blue
MIL3/4BLUEMONSTER	3/4" x 1429"	Blue
MIL1BLUEMONSTER	1" x 1429"	Blue

Yellow Teflon Tape For Gas Line



- . Extra heavy PTFE teflon tape for gas lines

Part No#	Size	Color
HARYELLOWTAPE1/2	1/2" x 260"	Yellow

Clear Thread Cutting Oil



- . Clear oil ideal for hand threaders

Part No#	Size	Color
OATCLEARCUTTINGOILQT	32oz	Clear
OATCLEARCUTTINGOILGA	128oz	Clear

Dark Thread Cutting Oil



- . Dark oil idea for actual thread cutting machines

Part No#	Size	Color
OATDARKCUTTINGOILGAL	128oz	Dark

Brown Jersey Gloves



- . 100% cotton
- . One size fits all

Part No#	Description	Qty
EMCJERSEYGLOVEPR	Brown Jersey Gloves	Pair

Advanced Nitex P-200 Gloves



- . Black nitex gloves
- . Specify size upon ordering!

Part No#	Size	Color
ADVP200BKXL	L	Black
ADVP200BKXL	XL	Black
ADVP200BKXL	XXL	Black

Latex Gloves



- . 100 gloves per box
- . Easy grip latex material
- . Great barrier protection

Part No#	Size	Type
SHUBEELATEXL	L	Latex
SHUBEELATEXXL	XL	Latex

Yellow Gritty Sewer Gloves



- . Hard PVC embedded outer shell
- . Soft jersey lined inside
- . Drain snake cleaning gloves

Part No#	Size	Type
SHUBEEYELLOWGRIT	One Size Fits Most	Yellow Gritty

Standard Shoe Covers



- . Blue disposable shoe covers

Part No#	Size	Qty
EMCSHOECOVERBX	XL	100 Per Box

Heavy Duty Waterproof Shoe Covers



- . Prevents tracking dirt and debris into home
- . Strong durable material
- . Waterproof

Part No#	Size	Qty
SHUBEEWPBLUE	Maximum Size 18 Boot	100 Per Box

Heavy Duty Original Shoe Covers



- . Prevents tracking dirt and debris into home
- . Strong durable material

Part No#	Size	Qty
SHUBEEORIGINAL	Maximum Size 18 Boot	100 Per Box

Safety Glasses



- . Clear plastic eye protection

Part No#	Description	Type
EMCSAFETYGLASS	Safety Glasses	Plastic

Hand Cleaning Towels



- . Anti-bacterial, ready to use
- . Removes plastic PVC cement

Part No#	Description	Qty
HERTUBTOWEL	Hand Cleaning Towels	70 Towels

Heavy Duty Contractor Bags



- . 20 bags per box
- . 42 gallon
- . 3 mil

Part No#	Description	Size
WALCONTRACTORBAGS	Contractor Bags	42 Gallon

Wood Shovel



- . Wooden handle
- . Round steel point

Part No#	Description	Qty
JONSHOVEL	Wood Shovel	Each

Steel Nipple Carrier



- . Heavy duty nipple tray carrier
- . Holds 66 nipples

Part No#	Size	Type
EMCNIPPLETRAY1/2	1/2	Steel
EMCNIPPLETRAY3/4	3/4	Steel
EMCNIPPLETRAY1	1	Steel

Steel Fitting Tray



- . Heavy duty fitting tote tray
- . Contains 8 dividers

Part No#	Size	Type
PASMETALFTGTRAY	20" x 10" x 5"	18 Gauge

Electrical Tape



- . General purpose electrical tape
- . 7 mil Vinyl material

Part No#	Size	Color
EMCBLKELECTRICALTAPE	3/4" x 66ft	Black

Heavy Duty Duct Tape



- . Provides heavy duty adhesion to several surfaces
- . Color options include silver and black

Part No#	Size	Color
HARSILVERDUCTTAPE	2" x 180ft	Silver
HARBLKDUCTTAPE	2" x 180ft	Black

Plastic Zip Ties



- . Nylon white plastic material
- . BAG QUANTITY ONLY

Part No#	Size	Qty
EMCZIPTIES6	6"	100/Bag
EMCZIPTIES11	11"	100/Bag

Rubber Bungy Cord



- . Rubber bungy cord

Part No#	Size	Type
EMCBUNGYCORD31	31"	Rubber

Stack Style Plunger



- . 21" long yellow handle
- . Black rubber cap

Part No#	Size	Type
HARPLUNGER6	21"	Rubber

9' Pigtail Cord



- . 9' long pigtail cord

Part No#	Size	Type
EMCEXTCORD9'PIGTAIL	9'	Pigtail Cord

25' Trouble Light



- . Trouble light with 25' cord
- . Metal cage

Part No#	Size	Type
EMCTROUBLELIGHT25	25'	Trouble Light

Extension Cord



- . Heavy duty yellow extension cord
- . Available in 25', 50' & 100' lengths

Part No#	Size	Type
EMCEXTCORD25'	25'	Yellow
EMCEXTCORD50'	50'	Yellow
EMCEXTCORD100'	100'	Yellow